

THE ITALIAN
COLLECTION



GIUSTI



ORIGINAL
DECORATIVE
CABINET
HARDWARE
SINCE 1967

Made in Italy

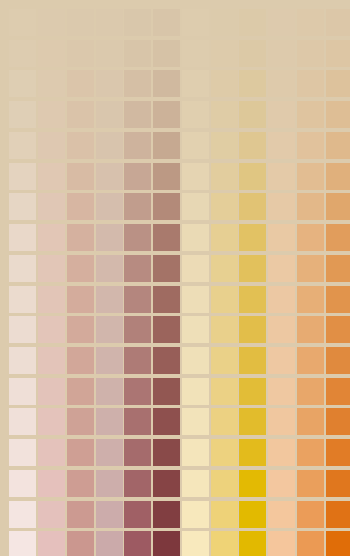



GIUSTI



Giusti TM
international registered

Il presente catalogo è di proprietà della Giusti S.p.a. È vietata la riproduzione e alterazione anche in forma digitale o fotografica.

This catalogue is property of the company Giusti S.p.A. The reproduction or every alteration even in digital or photographic form is severely forbidden.

Copyright © 2014
Giusti S.p.a.
All rights reserved.

AZIENDA



LA STORIA

Da 45 anni Giusti produce maniglie ed accessori per mobili con particolare attenzione alle esigenze della clientela con grande passione per la lavorazione dei metalli.

L'amore per il lavoro e per la propria terra di origine hanno fatto sì che l'intraprendenza della nuova generazione della famiglia garantisse l'espansione ed il rinnovo continuo dell'azienda fino ad arrivare ad esportare i propri prodotti nei cinque continenti.

MISSION

La missione di Giusti è il valore alla creatività, la precisione produttiva e la celerità del servizio verso qualsiasi mercato di riferimento. La concezione del prodotto Giusti parte dalla ricerca nel disegno: creare nuove forme per garantire una "presa" sicura.

IL MARCHIO

Il nostro marchio è sinonimo di garanzia, il valore acquisito in decenni di lavoro è tutto raffigurato nel nostro marchio. Giusti TM è un marchio internazionale. Diffidate dalle imitazioni.

BREVETTI

Le nostre idee ed ovviamente ogni nostro modello ornamentale sono protetti da brevetto internazionale, difendiamo le nostre creazioni.

ECOLOGIA

L'attenzione all'ambiente che ci circonda è parte integrante della nostra politica aziendale. Tutti i processi di produzione rispettano le più strette normative europee in tema di ecologia. E' indispensabile lasciare un mondo pulito alle generazioni future come eredità del nostro lavoro.

COMPANY



HISTORY

At Giusti we have been manufacturing handles and furniture accessories for 45 years, with special care and attention to our customers' needs and with a passion for metal processing.

The love for our work and place of origin has been passed on to the next generation of the Giusti family who are continuing the metal business in increasingly innovative ways. We are also continually expanding and now export our products to all five continents.

MISSION

Giusti's mission is to provide value and creativity, to ensure precision in production, and give prompt service to all markets. The idea of a Giusti product is formed when we research the design where the aim is to create new shapes that guarantee safe "holds".

BRAND

Our brand is synonymous with value. After many decades of work we can guarantee that our product represents true value. Giusti™ is international registered. Beware of imitations!

PATENTS

Our creations and all our decorative models are protected by international patents. We defend our property.

ENVIRONMENT

Environmental awareness is very important to us and is an integral part of company policy. All production processes comply with the most stringent environmental European regulations. The legacy of our work is to leave a clean world for future generations.

MERCHANDISING

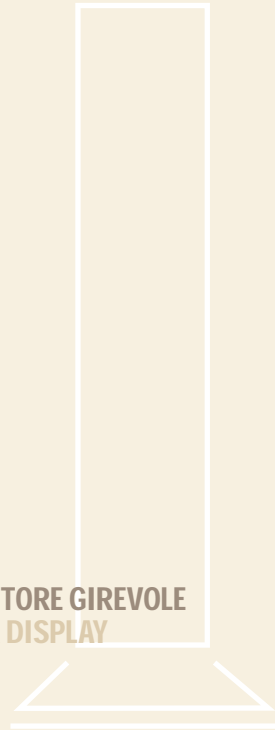
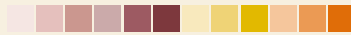

ESPOSITORE GIREVOLE
TOWER DISPLAY



PANNELLO ESPOSITORE
DISPLAY BOARD



BORSA CAMPIONARIO
SAMPLES BAG



SCATOLE IMBALLO
PACKAGING

SHOWROOM



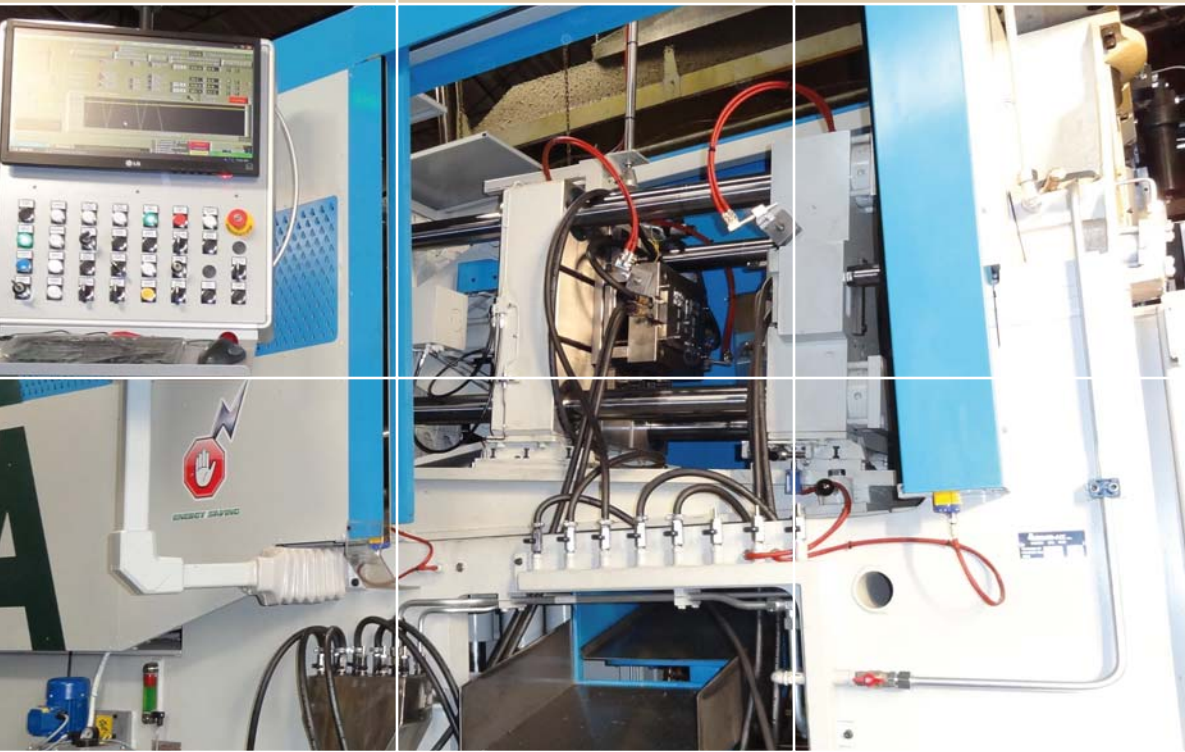

made in giusti

ORIGINAL
DECORATIVE
CABINET
HARDWARE
SINCE 1967

Made in Italy



Tecnologia
Technology

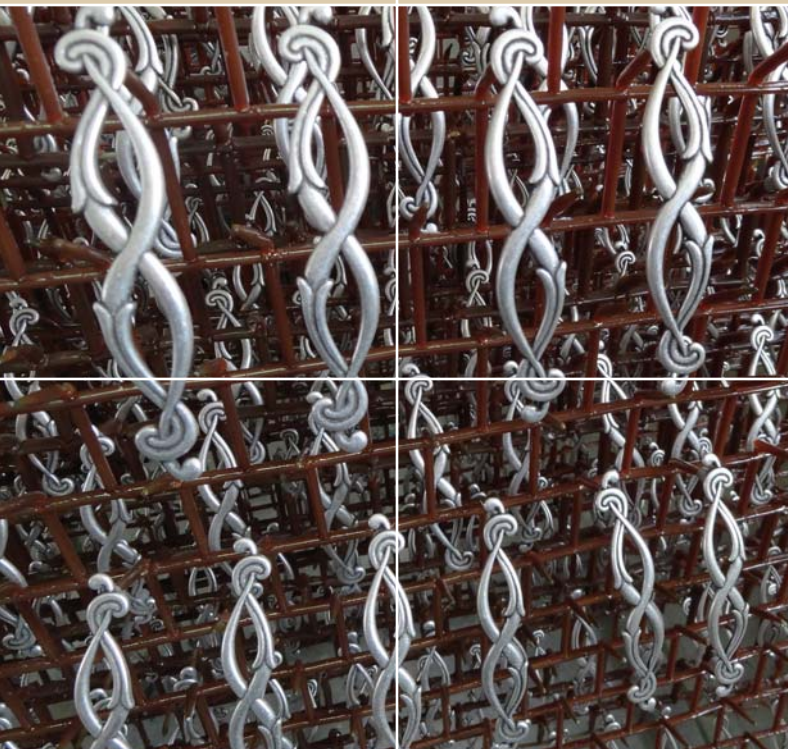

Esperienza
Experience



Qualità
Quality





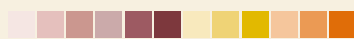



INDEX



GENERAL INDEX PAGE 464
PHOTO INDEX PAGE 476

INDEX



	DESIGN	> 011
	<i>Decor</i>	> 059
	<i>Classic</i>	> 177
	<i>Old Style</i>	> 249
	<i>Romantic</i>	> 307
	<i>Customize</i>	> 331
	<i>Best Sellers</i>	> 355
	<i>Basic</i>	> 417
	<i>Ceramics</i>	> 433
	<i>Luxury</i>	> 437





DESIGN

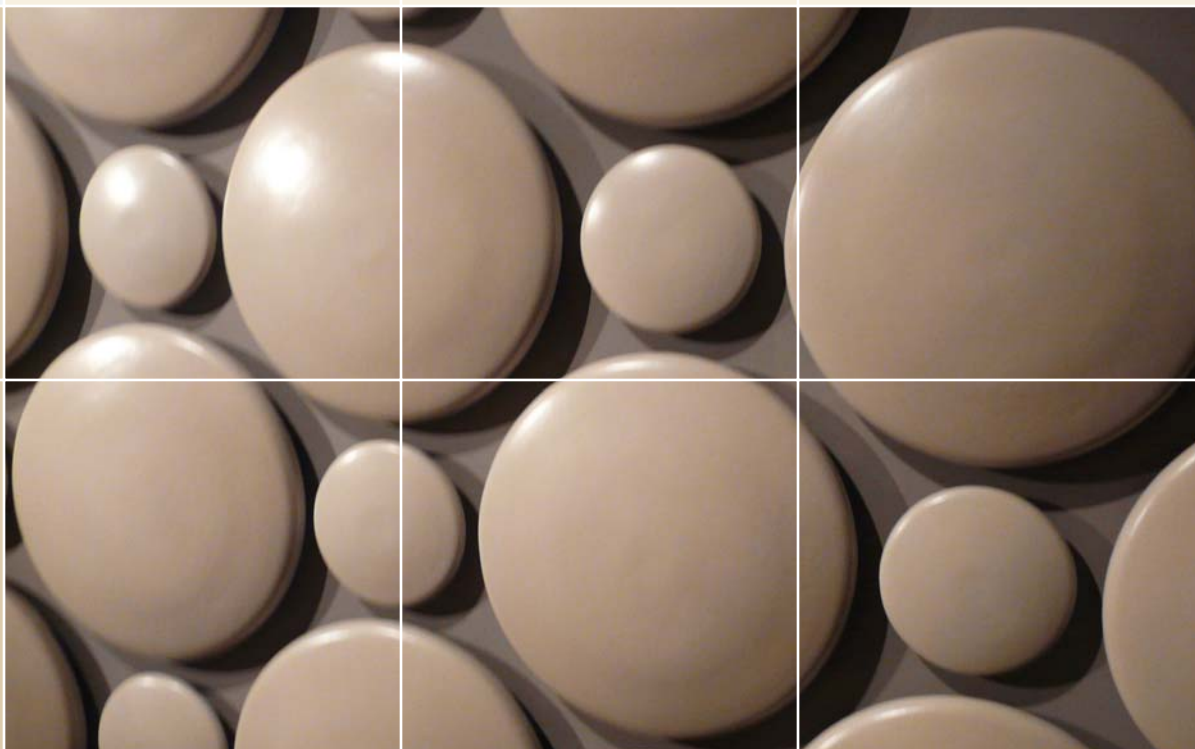

FINITURE LINEA DESIGN

DESIGN FINISHES

 0001 > VERNICIATO ALLUMINIO OPACO VARNISHED ALUMINIUM MATT	 0005 > NICHEL OPACO NICKEL MATT	 00F7 > VERNICIATO NICHEL SATINATO VARNISHED NICKEL SATINED
 0002 > CROMO LUCIDO POLISHED CHROME	 0006 > ACCIAIO INOX SATINATO STAINLESS STEEL SATINED	 00L8 > TOTAL BLACK NICHEL TOTAL BLACK NICKEL
 0003 > NICHEL SATINATO NICKEL SATINED	 0007 > VERNICIATO "CHAMPAGNE" OPACO VARNISHED "CHAMPAGNE" MATT	 AN > ALLUMINIO ANODIZZATO ALUMINIUM ANODIZED
 0004 > CROMO OPACO MATT CHROME	 0013 > CROMO "VELO" CHROME "VELO"	

SIMBOLOGIA

SYMBOLOLOGY



INTERASSE
DISTANCE BETWEEN CENTRES



ALTEZZA
HEIGHT



DIAMETRO
DIAMETER



LUNGHEZZA
LENGHT



LARGHEZZA
WIDTH



LUNGHEZZA CHIAVE
KEY LENGHT



LINEA
DESIGN

SERIE 005



GIUSTI

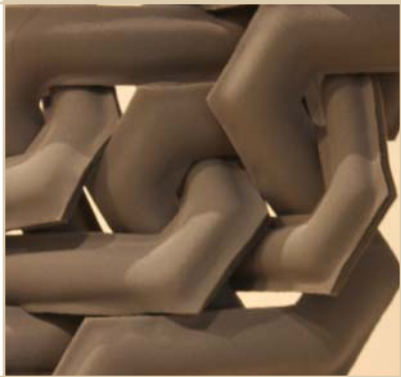

WP0005.A32

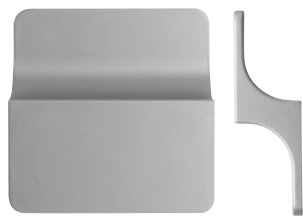

32	75	24	75

WP0005.B32

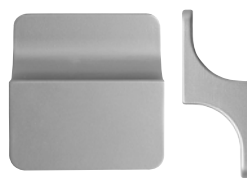

32	60	24	60

FINITURE / FINISHING

- 0001 > VERNICIATO ALLUMINIO OPACO
VARNISHED ALUMINIUM MATT
- 0002 > CROMO LUCIDO
POLISHED CHROME
- 0003 > NICHEL SATINATO
NICKEL SATINED



LINEA
DESIGN
 SERIE 119

GIUSTI

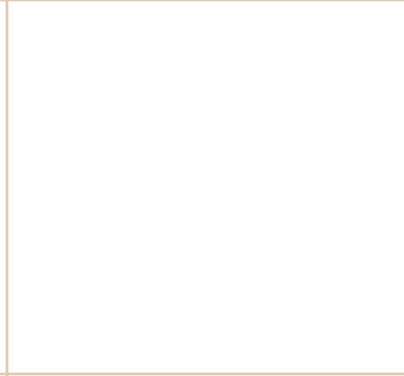
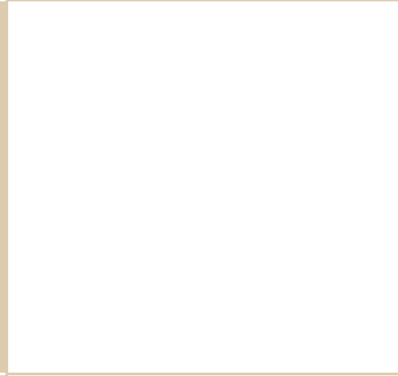
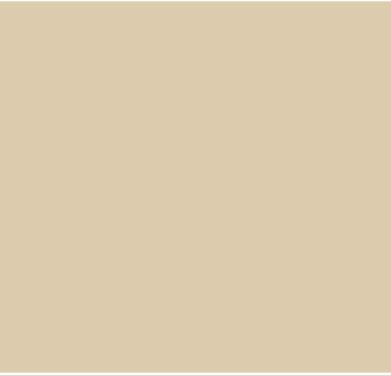
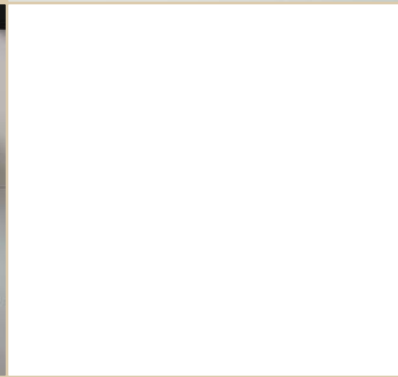
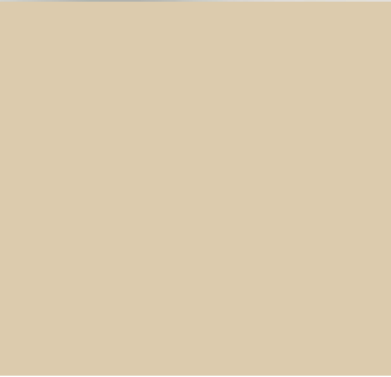
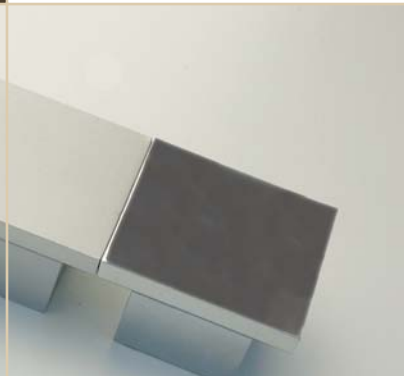
WP0119.016

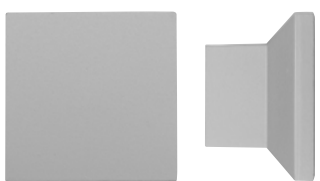

16	38	25	38

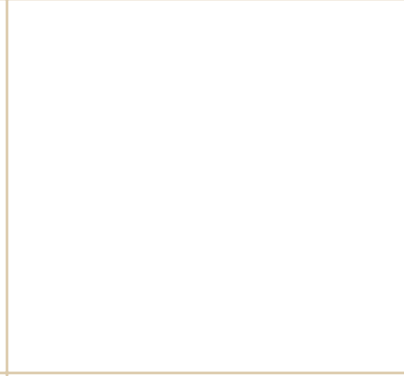
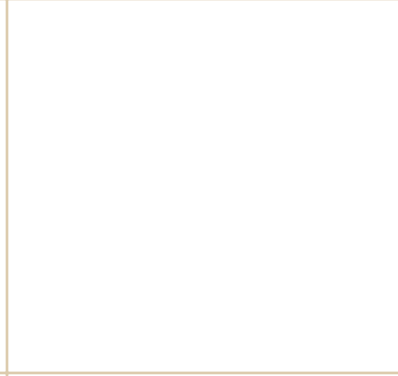

FINITURE / FINISHING

-  0001 > VERNICIATO ALLUMINIO OPACO
VARNISHED ALUMINIUM MATT
-  0002 > CROMO LUCIDO
POLISHED CHROME
-  0003 > NICHEL SATINATO
NICKEL SATINED



LINEA
DESIGN

SERIE 019



GIUSTI

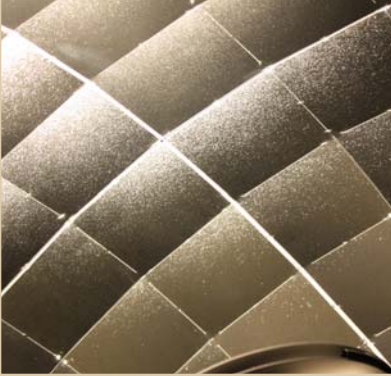

WP0019.A32



32	70	25	70

FINITURE / FINISHING

-  0001 > VERNICIATO ALLUMINIO OPACO
VARNISHED ALUMINIUM MATT
-  0002 > CROMO LUCIDO
POLISHED CHROME
-  0003 > NICHEL SATINATO
NICKEL SATINED



LINEA
DESIGN
SERIE 300



GIUSTI

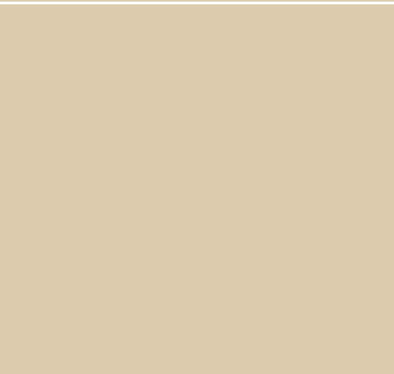
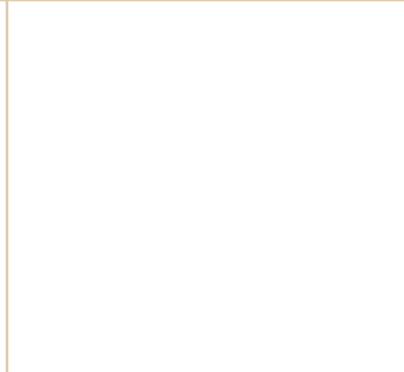
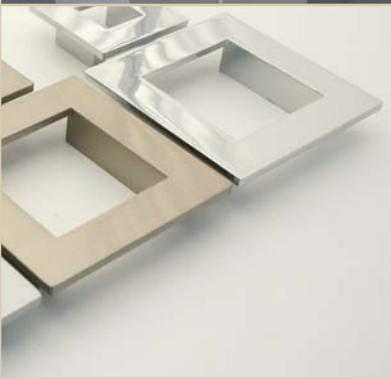
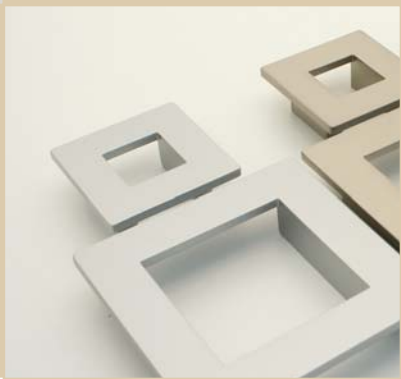
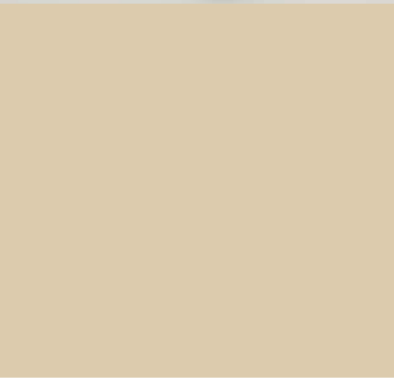

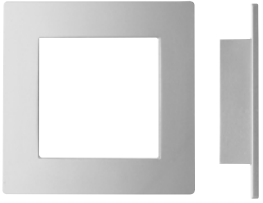

WMN300.064

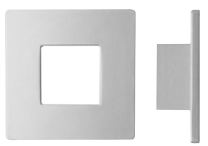

64	90	18	90

WMN300.032



32	54	18	54

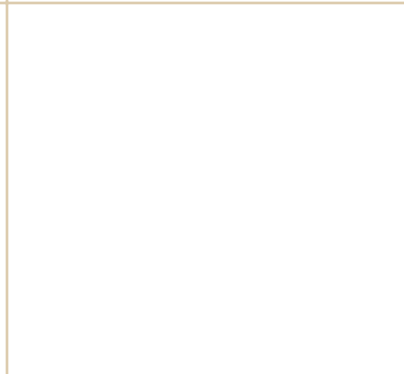

FINITURE / FINISHING

-  0001 > VERNICIATO ALLUMINIO OPACO
VARNISHED ALUMINIUM MATT
-  0002 > CROMO LUCIDO
POLISHED CHROME
-  0003 > NICHEL SATINATO
NICKEL SATINED

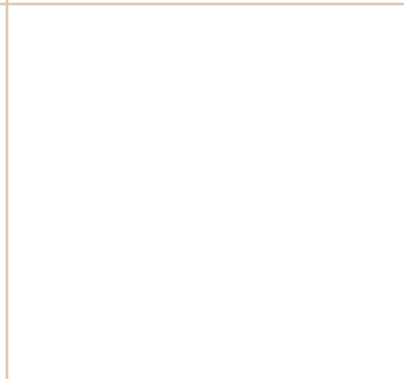
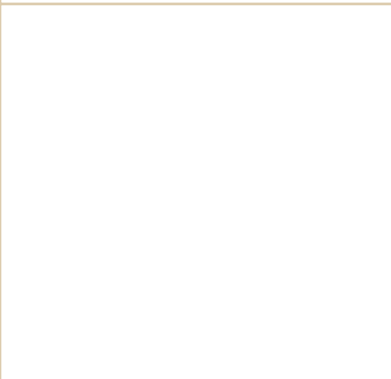
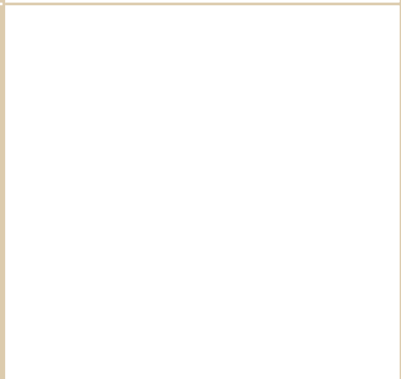

LINEA DESIGN

SERIE 329



GIUSTI



COMBINAZIONE COLORI / COLOUR-MATCHING

0101

BASE > 01 VARNISHED ALUMINIUM MATT

INSERT > 01 VARNISHED ALUMINIUM MATT

0201

BASE > 01 VARNISHED ALUMINIUM MATT

INSERT > 02 POLISHED CHROME

0301

BASE > 01 VARNISHED ALUMINIUM MATT

INSERT > 03 NICKEL SATINED

0102

BASE > 02 POLISHED CHROME

INSERT > 01 VARNISHED ALUMINIUM MATT

0202

BASE > 02 POLISHED CHROME

INSERT > 02 POLISHED CHROME

0302

BASE > 02 POLISHED CHROME

INSERT > 03 NICKEL SATINED

0103

BASE > 03 NICKEL SATINED

INSERT > 01 VARNISHED ALUMINIUM MATT

0203

BASE > 03 NICKEL SATINED

INSERT > 02 POLISHED CHROME

0303

BASE > 03 NICKEL SATINED

INSERT > 03 NICKEL SATINED

FINITURE / FINISHING

 0001 > VERNICIATO ALLUMINIO OPACO
VARNISHED ALUMINIUM MATT

 0002 > CROMO LUCIDO
POLISHED CHROME

 0003 > NICHEL SATINATO
NICKEL SATINED

WP0329.A16

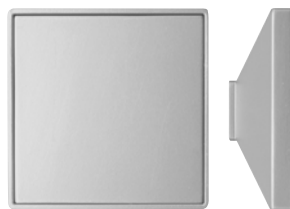

16	76	24	76

WP0329.B16



16	60	24	60

LINEA
DESIGN

SERIE 040



GIUSTI

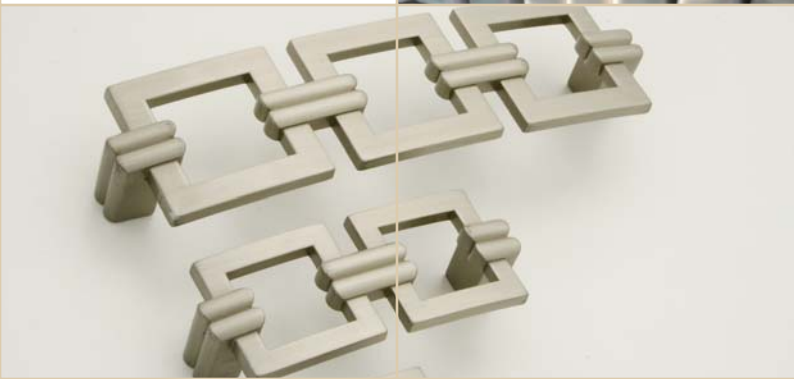
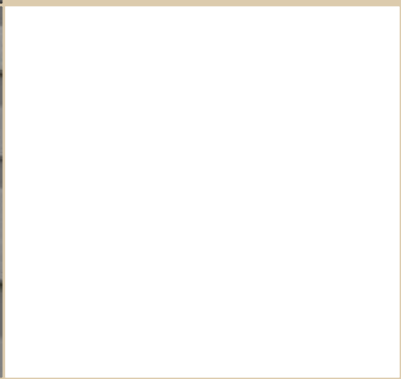
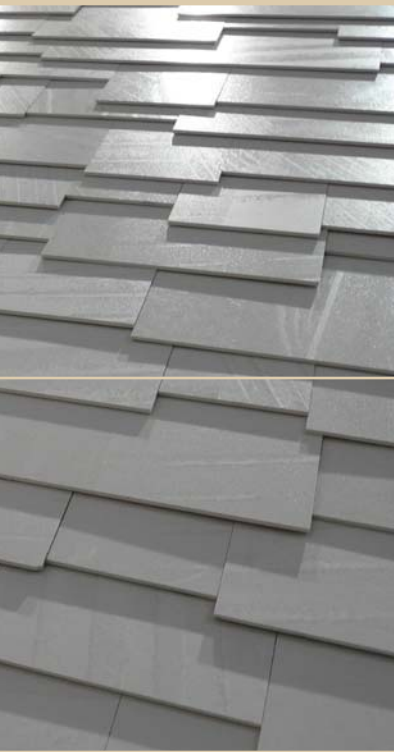

WMN040.128

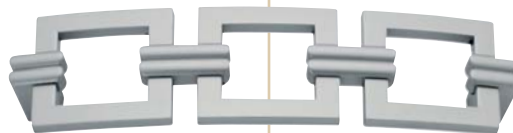

128	140	23	38

WMN040.064

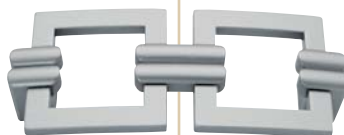

64	77	20	32

WP0040.032



32	44	20	35

FINITURE / FINISHING

0001 > VERNICIATO ALLUMINIO OPACO
VARNISHED ALUMINIUM MATT

0002 > CROMO LUCIDO
POLISHED CHROME

0003 > NICHEL SATINATO
NICKEL SATINED

00D1 > ANTICA FIRENZE
ANTIQUÉ FLORENCE

00E8 > ARGENTO VECCHIO BRILLANTE
SHINY OLD SILVER

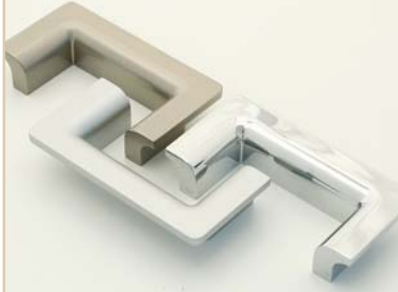

LINEA DESIGN

SERIE 334



GIUSTI

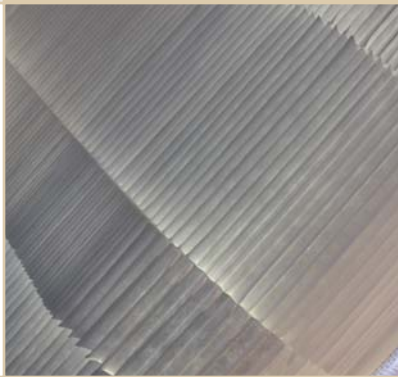
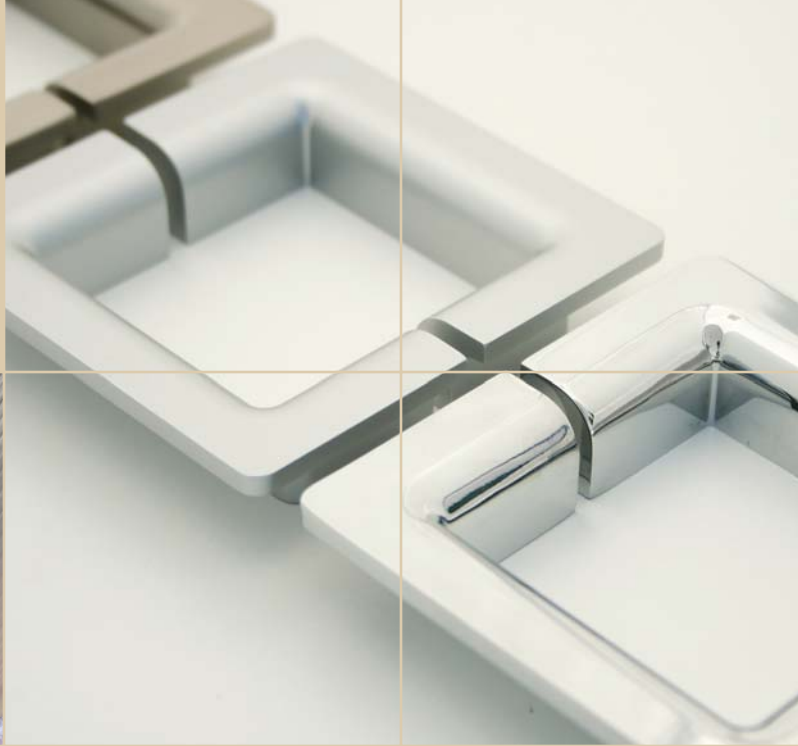

WMN334.064

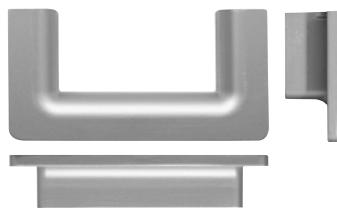

64	87	18	44

FINITURE / FINISHING

- 0001 > VERNICIATO ALLUMINIO OPACO
VARNISHED ALUMINIUM MATT
- 0002 > CROMO LUCIDO
POLISHED CHROME
- 0003 > NICHEL SATINATO
NICKEL SATINED



LINEA
DESIGN

SERIE 030-031



GIUSTI



WMN030.064
WMN030.096
WMN030.128
WMN030.160
WMN030.192
WMN030.224
WMN030.320

⊕ ⊕	↔	↑	↓
64	74	32	10
96	106	32	10
128	138	32	10
160	170	32	10
192	202	32	10
224	234	32	10
320	330	32	10



∅ 10

WMN031.096
WMN031.128
WMN031.160
WMN031.192
WMN031.224
WMN031.320
WMN031.448
WMN031.640
WMN031.736

⊕ ⊕	↔	↑	↓
96	110	35	14
128	142	35	14
160	174	35	14
192	206	35	14
224	238	35	14
320	334	35	14
448	462	35	14
640	654	35	14
736	750	35	14



∅ 14

FINITURE / FINISHING

0006 > ACCIAIO INOX SATINATO
STAINLESS STEEL SATINED



LINEA
DESIGN

SERIE 011



GIUSTI



WMN011.192



192	210	22	12

WMN011.128



128	146	22	12

FINITURE / FINISHING

-  0001 > VERNICIATO ALLUMINIO OPACO
VARNISHED ALUMINIUM MATT
-  0002 > CROMO LUCIDO
POLISHED CHROME
-  0003 > NICHEL SATINATO
NICKEL SATINED



LINEA DESIGN

SERIE 001



GIUSTI

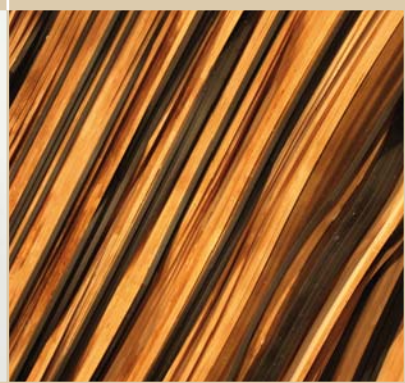

WMN001.320



ϕ	\leftrightarrow	\updownarrow	\updownarrow
320	331	32	11

WMN001.192



ϕ	\leftrightarrow	\updownarrow	\updownarrow
192	204	32	11

WMN001.160



ϕ	\leftrightarrow	\updownarrow	\updownarrow
160	171	32	11

FINITURE / FINISHING

-  0001 > VERNICIATO ALLUMINIO OPACO
VARNISHED ALUMINIUM MATT
-  0002 > CROMO LUCIDO
POLISHED CHROME
-  0003 > NICHEL SATINATO
NICKEL SATINED
-  00L8 > TOTAL BLACK NICHEL
TOTAL BLACK NICKEL



LINEA DESIGN

SERIE 022



GIUSTI

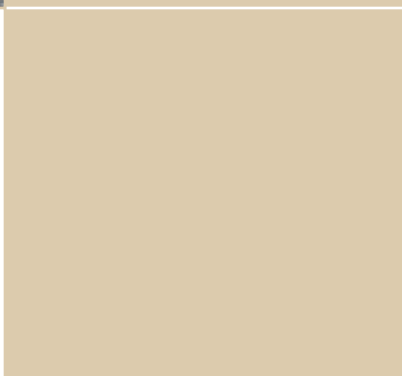
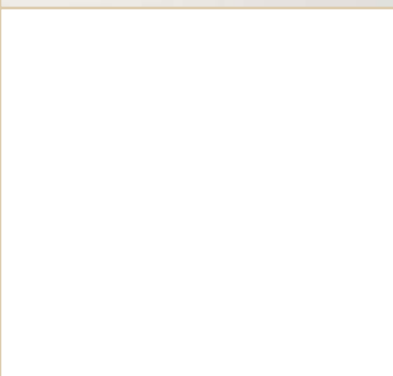
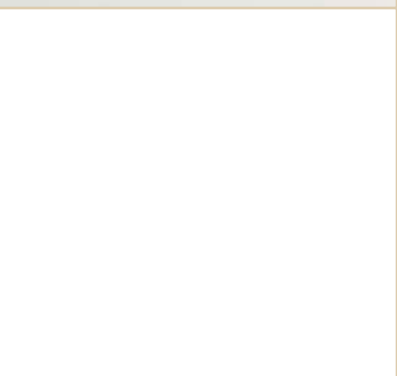
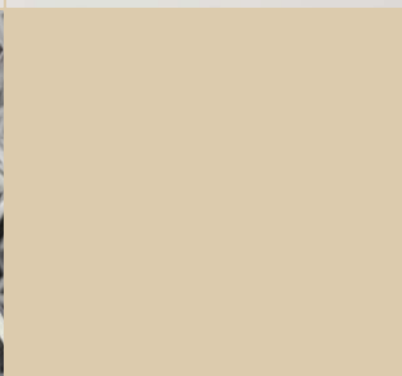

∅ 10

	∅	↔	⊥	∅
WMN022.096	96	106	35	10
WMN022.128	128	138	35	10
WMN022.160	160	170	35	10
WMN022.192	192	202	35	10
WMN022.224	224	234	35	10
WMN022.320	320	330	35	10
WMN022.448	448	458	35	10
WMN022.640	640	650	35	10
WMN022.736	736	746	35	10

FINITURE / FINISHING

0006 > ACCIAIO INOX SATINATO
STAINLESS STEEL SATINED



LINEA
DESIGN

SERIE 187



GIUSTI

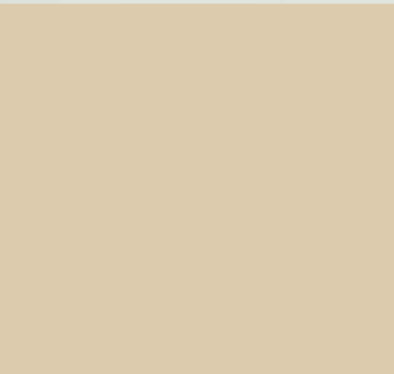

WMN187.224



224	236	22	12

WMN187.160



160	172	22	12

FINITURE / FINISHING

-  0001 > VERNICIATO ALLUMINIO OPACO
VARNISHED ALUMINIUM MATT
-  0002 > CROMO LUCIDO
POLISHED CHROME
-  0003 > NICHEL SATINATO
NICKEL SATINED

WMN187.128



128	140	22	12

WMN187.096



96	108	22	12



LINEA
DESIGN

SERIE 309



GIUSTI



WMN309.192

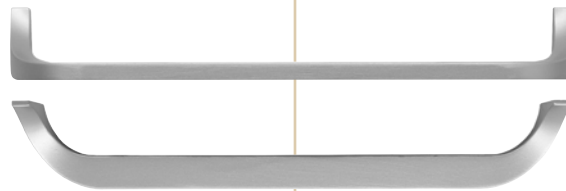

192	198	32	26

WMN309.128

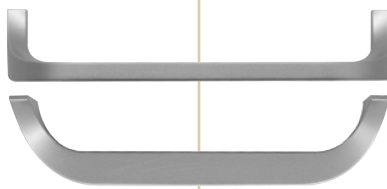

128	134	32	26

FINITURE / FINISHING

- 0001 > VERNICIATO ALLUMINIO OPACO
VARNISHED ALUMINIUM MATT
- 0002 > CROMO LUCIDO
POLISHED CHROME
- 0003 > NICHEL SATINATO
NICKEL SATINED



LINEA
DESIGN

SERIE 009



GIUSTI



WMN009.032

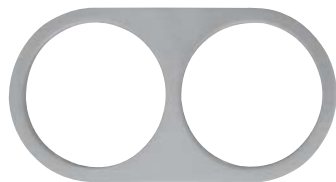

32	87	20	46

FINITURE / FINISHING

- 0001 > VERNICIATO ALLUMINIO OPACO
VARNISHED ALUMINIUM MATT
- 0002 > CROMO LUCIDO
POLISHED CHROME
- 0003 > NICHEL SATINATO
NICKEL SATINED

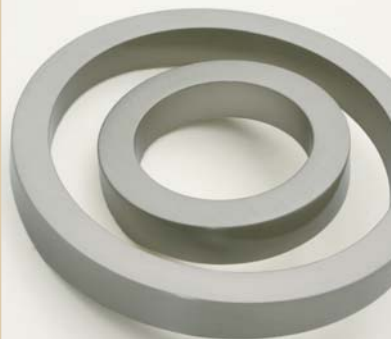

LINEA
DESIGN

SERIE 317



GIUSTI

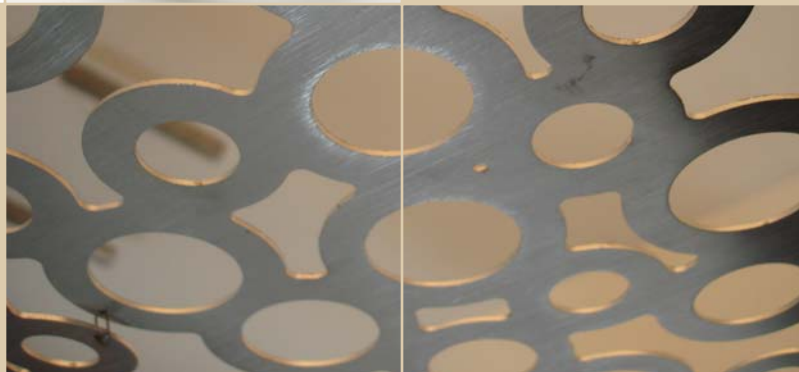

WMN317.064

\varnothing	$\overline{\Delta}$	\overline{A}	\overline{B}
64	100	28	100

WMN317.032

\varnothing	$\overline{\Delta}$	\overline{A}	\overline{B}
32	60	28	60

FINITURE / FINISHING

-  0001 > VERNICIATO ALLUMINIO OPACO
VARNISHED ALUMINIUM MATT
-  0002 > CROMO LUCIDO
POLISHED CHROME
-  0003 > NICHEL SATINATO
NICKEL SATINED



LINEA DESIGN

SERIE 400 - 401 - 402



GIUSTI

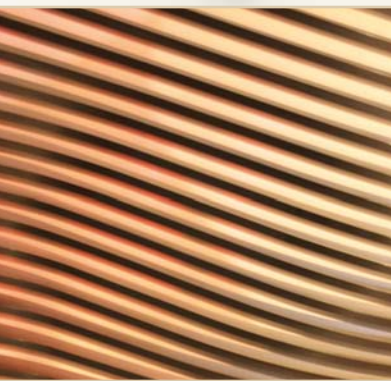

WMN400.W32



⌀	⌀	↔	↑	↓
128-192	256	30	26	

WMN400.K32



⌀	⌀	↔	↑	↓
96-160	225	30	26	

WMN401.W32



⌀	↔	↑	↓
32	26	38	190

WMN401.K32









⌀	↔	↑	↓
32	26	36	160

WMN401.H32



⌀	↔	↑	↓
32	26	34	135

FINITURE PELLE / LEATHER FINISHING

-  .02A1 > BROWN WITH STAINLESS STEEL WIRE
-  .02A2 > BEIGE WITH STAINLESS STEEL WIRE
-  .02A3 > WHITE WITH STAINLESS STEEL WIRE
-  .02P1 > MARRONE / BROWN
-  .02P2 > BEIGE / BEIGE
-  .02P3 > BIANCO / WHITE

WMN402.W32



⌀	↔	↑	↓
32	150	30	26

WMN402.K32



⌀	↔	↑	↓
32	124	25	26

FINITURE METALLO / METAL FINISHING

-  .02A1 > CROMO LUCIDO / POLISHED CHROME
-  .03A1 > NICHEL SATINATO / NICKEL SATINED



LINEA DESIGN

SERIE 403 - 404 - 405



GIUSTI



WMN403.W16



128-160	215	28	17

WMN403.K16



96-128	180	28	17

WMN403.H16



64-96	150	25	17

WMN404.W16



16	17	27	120

WMN404.K16



16	17	26	105

WMN404.H16



16	17	25	96

WMN404.T16



16	17	24	86

WMN404.S16



16	17	27	104

WMN404.Z16



16	17	25	76

WMN405.W16

16	103	27	17



WMN405.H16

16	78	23	17



WMN405.K16

16	90	25	17



WMN405.T16

16	68	22	17



FINITURE PELLE / LEATHER FINISHING

- .02A1 > BROWN WITH STAINLESS STEEL WIRE
- .02A2 > BEIGE WITH STAINLESS STEEL WIRE
- .02A3 > WHITE WITH STAINLESS STEEL WIRE
- .02P1 > MARRONE / BROWN
- .02P2 > BEIGE / BEIGE
- .02P3 > BIANCO / WHITE

FINITURE METALLO / METAL FINISHING

- .02A1 > CROMO LUCIDO / POLISHED CHROME
- .03A1 > NICHEL SATINATO / NICKEL SATINED



LINEA
DESIGN

SERIE 335



GIUSTI



WMN335.320



320	328	28	9

WMN335.128



128	136	28	9

FINITURE / FINISHING

-  0001 > VERNICIATO ALLUMINIO OPACO
VARNISHED ALUMINIUM MATT
-  0002 > CROMO LUCIDO
POLISHED CHROME
-  0003 > NICHEL SATINATO
NICKEL SATINED
-  00L8 > TOTAL BLACK NICHEL
TOTAL BLACK NICKEL



LINEA
DESIGN

SERIE 314



GIUSTI

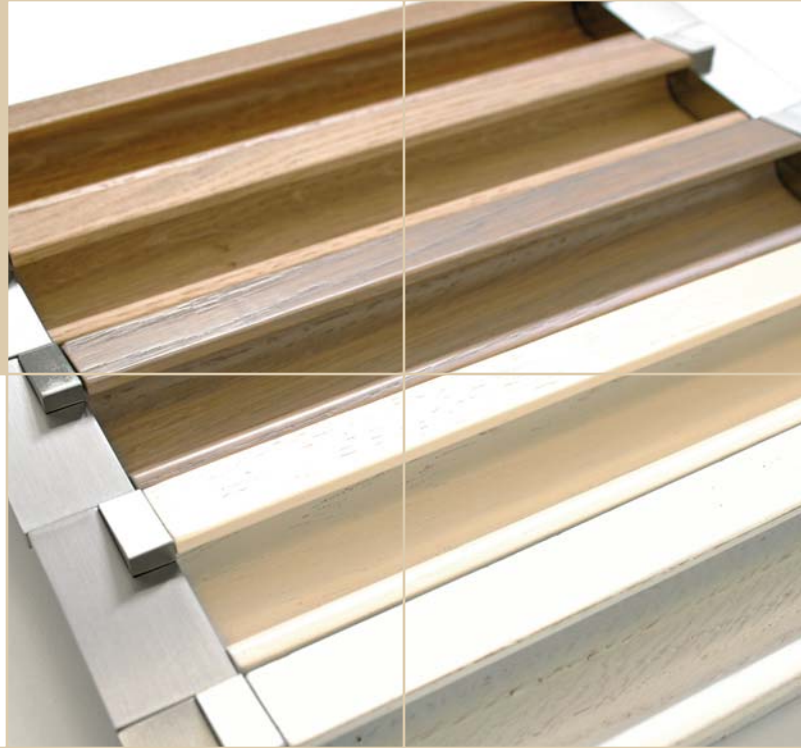

WMN314.192





INSERTO LEGNO / WOOD INSERT

 **RG00 > ROVERE GREZZO**
RAW OAK

			
192	226	(14)	44

(*) PERSONALIZZAZIONI POSSIBILI /
OTHER CUSTOM MADE POSSIBLE

FINITURE / FINISHING

 **RG02 > CROMO LUCIDO**
POLISHED CHROME
 **RG03 > NICHEL SATINATO**
NICKEL SATINED



LINEA
DESIGN

SERIE 691



GIUSTI

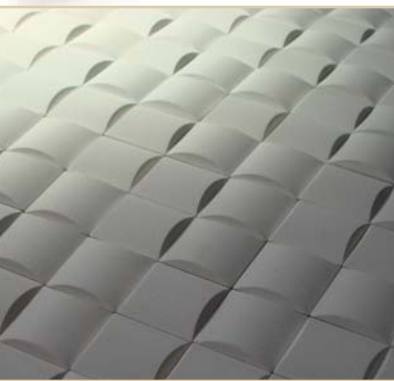

WMN691.032

32	25	22	75



WMN691.016

16	25	22	58

FINITURE / FINISHING

0001 > VERNICIATO ALLUMINIO OPACO
VARNISHED ALUMINIUM MATT

0002 > CROMO LUCIDO
POLISHED CHROME

00F7 > VERNICIATO NICHEL SATINATO
VARNISHED NICKEL SATINED

00D1 > ANTICA FIRENZE
ANTIQUÉ FLORENCE

00E8 > ARGENTO VECCHIO BRILLANTE
SHINY OLD SILVER



LINEA DESIGN

SERIE 336



GIUSTI

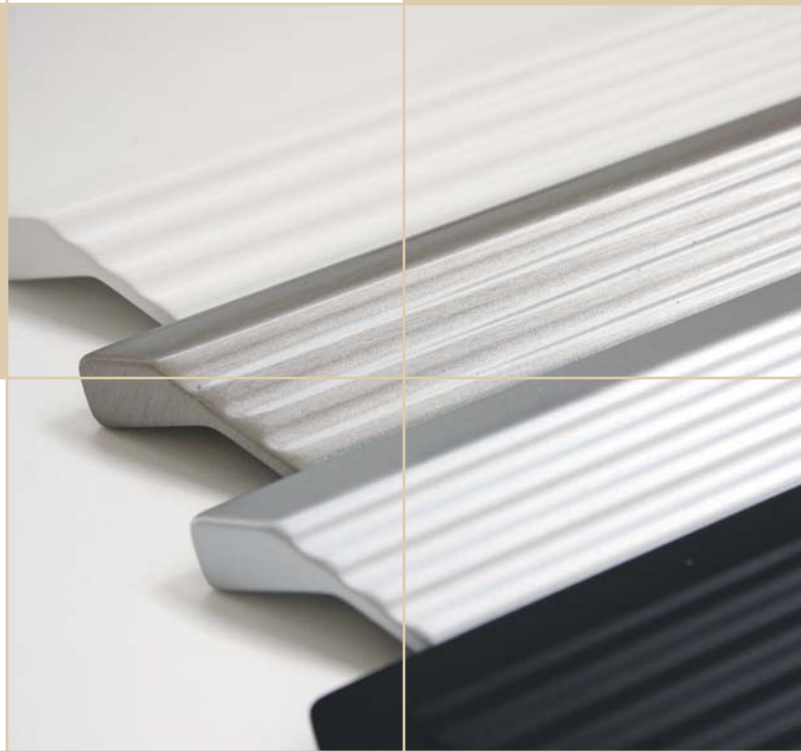

WMN336.128



128	150	30	24

FINITURE / FINISHING

-  0001 > VERNICIATO ALLUMINIO OPACO
VARNISHED ALUMINIUM MATT
-  00F7 > VERNICIATO NICHEL SATINATO
VARNISHED NICKEL SATINED
-  00N3 > LACCATO BIANCO MATT
WHITE MATT
-  00N4 > LACCATO NERO MATT
BLACK MATT

LINEA
DESIGN

SERIE 002



GIUSTI



WMN002.320



320	350	30	16

WMN002.192



192	222	30	16

WMN002.160



160	190	30	16

FINITURE / FINISHING

- 0001 > VERNICIATO ALLUMINIO OPACO
VARNISHED ALUMINIUM MATT
- 0002 > CROMO LUCIDO
POLISHED CHROME
- 0003 > NICHEL SATINATO
NICKEL SATINED
- 0013 > CROMO VELO
CHROME VELO



LINEA
DESIGN

SERIE 006



GIUSTI



WMN006.192



192	290	30	30

FINITURE / FINISHING



-  0001 > VERNICIATO ALLUMINIO OPACO
VARNISHED ALUMINIUM MATT
-  0002 > CROMO LUCIDO
POLISHED CHROME
-  0003 > NICHEL SATINATO
NICKEL SATINED
-  0013 > CROMO VELO
CHROME VELO

LINEA DESIGN

SERIE 108



FINITURE / FINISHING

-  0001 > VERNICIATO ALLUMINIO OPACO
VARNISHED ALUMINIUM MATT
-  00F7 > VERNICIATO NICHEL SATINATO
VARNISHED NICKEL SATINED



WMN108.192



WMN108.128



WMN108.192

WMN108.128

\varnothing	\leftrightarrow	\updownarrow	\updownarrow
192	204	20	13
128	140	20	13

LINEA DESIGN

SERIE 126



FINITURE / FINISHING

-  0001 > VERNICIATO ALLUMINIO OPACO
VARNISHED ALUMINIUM MATT
-  0002 > CROMO LUCIDO
POLISHED CHROME
-  0003 > NICHEL SATINATO
NICKEL SATINED

WMN126.192

WMN126.128

WMN126.096

WMN126.064

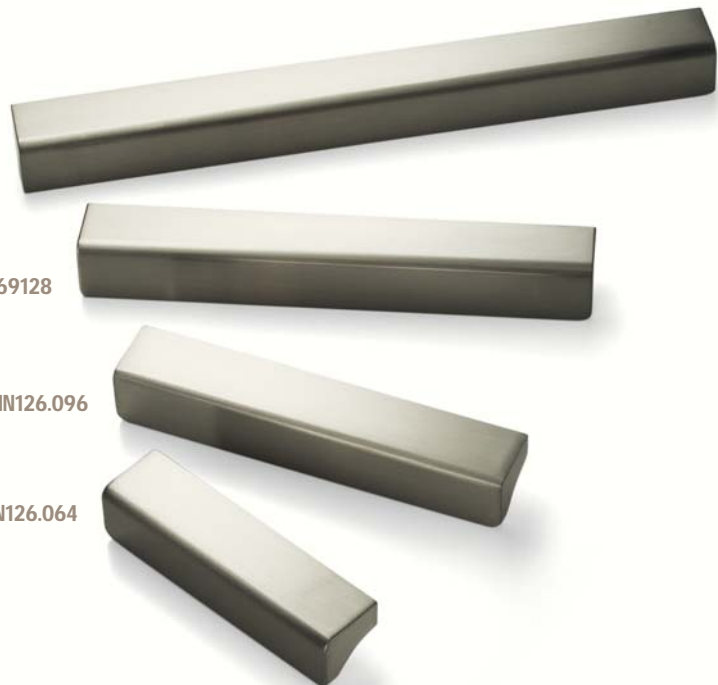

WMN126.192

WMN126.128

WMN126.096

WMN126.064

\varnothing	\leftrightarrow	\updownarrow	\updownarrow
192	208	20	18
128	144	20	18
96	112	20	18
64	80	20	18



WMN134.160



WMN145.160

LINEA DESIGN

SERIE 134 - 145

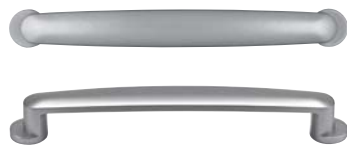

WMN134.160

160	194	28	22



WMN145.160

160	180	26	15

FINITURE / FINISHING

- 0001 > VERNICIATO ALLUMINIO OPACO
VARNISHED ALUMINIUM MATT
- 0003 > NICHEL SATINATO



WMN180.128

LINEA DESIGN

SERIE 180



WMN180.128

128	138	25	20

FINITURE / FINISHING

- 0001 > VERNICIATO ALLUMINIO OPACO
VARNISHED ALUMINIUM MATT
- 0003 > NICHEL SATINATO
NICKEL SATINED

LINEA DESIGN

SERIE 138



WMN138.192

WMN138.128

FINITURE / FINISHING

-  0001 > VERNICIATO ALLUMINIO OPACO
VARNISHED ALUMINIUM MATT
-  0003 > NICHEL SATINATO
NICKEL SATINED

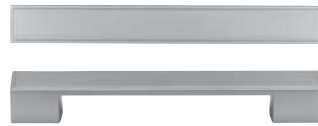

WMN138.192
WMN138.128

192	224	28	28
128	190	28	26

LINEA DESIGN

SERIE 136 - 140



WMN140.192

WMN136.192

FINITURE / FINISHING

-  0001 > VERNICIATO ALLUMINIO OPACO
VARNISHED ALUMINIUM MATT
-  0003 > NICHEL SATINATO
NICKEL SATINED



WMN136.192

192	232	26	26

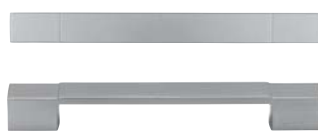

WMN140.192

192	224	28	22

WMN107.128



WMN182.128



LINEA
DESIGN

SERIE 107 - 182







FINITURE / FINISHING

-  0001 > VERNICIATO ALLUMINIO OPACO
VARNISHED ALUMINIUM MATT
-  0003 > NICHEL SATINATO
NICKEL SATINED





WMN182.128

			
128	146	25	18



WMN107.128

			
128	135	30	22

WMN169.160



WMN169.128



LINEA
DESIGN

SERIE 169



FINITURE / FINISHING

-  0001 > VERNICIATO ALLUMINIO OPACO
VARNISHED ALUMINIUM MATT
-  0003 > NICHEL SATINATO
NICKEL SATINED

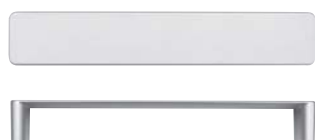

WMN169.160

WMN169.128

			
160	168	24	30
128	136	24	25

LINEA DESIGN

SERIE 101 - 154



WMN154.160



WMN101.128

FINITURE / FINISHING

-  0001 > VERNICIATO ALLUMINIO OPACO
VARNISHED ALUMINIUM MATT
-  0003 > NICHEL SATINATO
NICKEL SATINED



WMN154.160

160	225	26	20



WMN101.128

128	162	30	20

LINEA DESIGN

SERIE 102



WMN102.128

FINITURE / FINISHING

-  0001 > VERNICIATO ALLUMINIO OPACO
VARNISHED ALUMINIUM MATT
-  0002 > CROMO LUCIDO
POLISHED CHROME
-  0003 > NICHEL SATINATO
NICKEL SATINED



WMN102.128

128	172	32	18



WMN106.160

LINEA DESIGN

SERIE 106



WMN106.160

160	178	30	20

FINITURE / FINISHING

- 0001 > VERNICIATO ALLUMINIO OPACO
VARNISHED ALUMINIUM MATT
- 0002 > CROMO LUCIDO
POLISHED CHROME
- 0003 > NICHEL SATINATO
NICKEL SATINED



WMN153.160

WMN153.128

LINEA DESIGN

SERIE 153

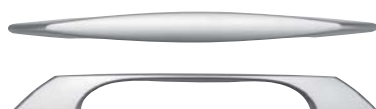

WMN153.160

WMN153.128

160	224	26	20
128	198	22	16

FINITURE / FINISHING

- 0001 > VERNICIATO ALLUMINIO OPACO
VARNISHED ALUMINIUM MATT
- 0003 > NICHEL SATINATO
NICKEL SATINED

LINEA DESIGN

SERIE 190



WMN190.224



WMN190.128



WMN190.096

FINITURE / FINISHING



0001 > VERNICIATO ALLUMINIO OPACO
VARNISHED ALUMINIUM MATT



WMN190.224

WMN190.128

WMN190.096

⊕ ⊕	↔	⊥	⊥
224	236	18	35
128	140	18	35
96	108	18	35

LINEA DESIGN

SERIE 152 - 191

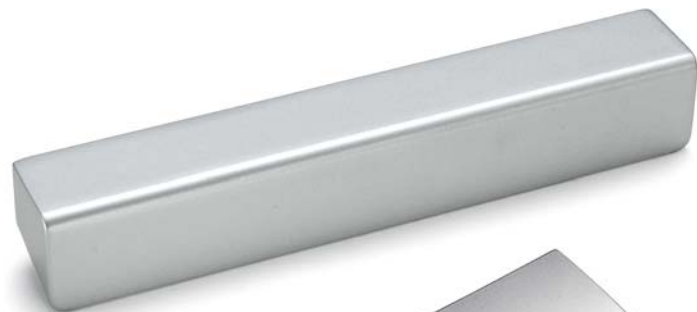

WMN191.128



WMN152.128

FINITURE / FINISHING



0001 > VERNICIATO ALLUMINIO OPACO
VARNISHED ALUMINIUM MATT



0003 > NICHEL SATINATO
NICKEL SATINED



WMN191.128

⊕ ⊕	↔	⊥	⊥
128	160	24	26



WMN152.128

⊕ ⊕	↔	⊥	⊥
128	140	24	50



WMN020.256

WMN020.192

LINEA DESIGN

SERIE 020

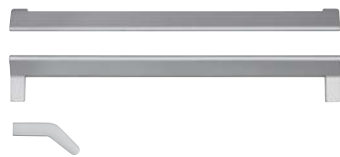

WMN020.256

WMN020.192

⌀	↔	↑	↓
256	268	38	18
192	204	38	18

FINITURE / FINISHING

-  0001 > VERNICIATO ALLUMINIO OPACO
VARNISHED ALUMINIUM MATT
-  0003 > NICHEL SATINATO
NICKEL SATINED



WMN025.096

LINEA DESIGN

SERIE 025



WMN025.096

⌀	↔	↑	↓
96	140	24	30

FINITURE / FINISHING

-  0001 > VERNICIATO ALLUMINIO OPACO
VARNISHED ALUMINIUM MATT
-  0002 > CROMO LUCIDO
POLISHED CHROME
-  0003 > NICHEL SATINATO
NICKEL SATINED

LINEA DESIGN

SERIE 130





WMN130.160

WMN130.128

WMN130.096

WMN130.064

FINITURE / FINISHING

-  0001 > VERNICIATO ALLUMINIO OPACO
VARNISHED ALUMINIUM MATT
-  0002 > CROMO LUCIDO
POLISHED CHROME
-  0003 > NICHEL SATINATO
NICKEL SATINED



WMN130.160

WMN130.128

WMN130.096

WMN130.064

	⊕ ⊕	↔	↑	↓
WMN130.160	160	200	30	12
WMN130.128	128	166	27	12
WMN130.096	96	126	25	12
WMN130.064	64	94	20	12

LINEA DESIGN

SERIE 142



WMN142.128

WMN142.096



FINITURE / FINISHING

-  0001 > VERNICIATO ALLUMINIO OPACO
VARNISHED ALUMINIUM MATT
-  0002 > CROMO LUCIDO
POLISHED CHROME
-  0003 > NICHEL SATINATO
NICKEL SATINED



WMN142.128

WMN142.096

	⊕ ⊕	↔	↑	↓
WMN142.128	128	168	25	18
WMN142.096	96	132	24	16



LINEA DESIGN

SERIE 132



WMN132.160
WMN132.128
WMN132.096
WMN132.064

⊕ ⊗	↔	⊥	⊥
160	186	28	14
128	154	28	14
96	122	25	14
64	90	21	14

FINITURE / FINISHING

-  0001 > VERNICIATO ALLUMINIO OPACO
VARNISHED ALUMINIUM MATT
-  0002 > CROMO LUCIDO
POLISHED CHROME
-  0003 > NICHEL SATINATO
NICKEL SATINED

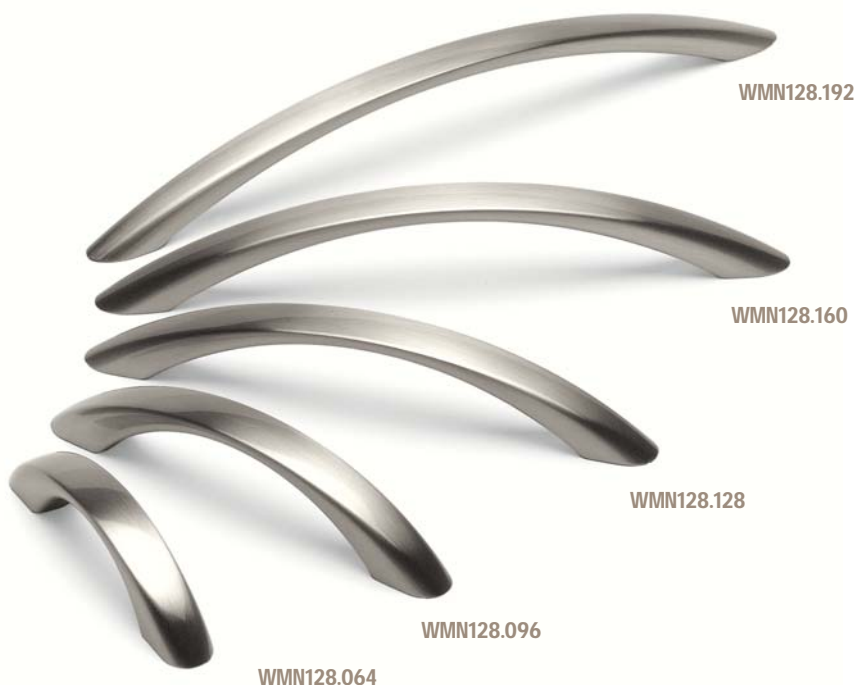

LINEA DESIGN

SERIE 128



WMN128.192
WMN128.160
WMN128.128
WMN128.096
WMN128.064

⊕ ⊗	↔	⊥	⊥
192	216	28	13
160	184	28	13
128	152	26	13
96	120	25	13
64	88	22	13

FINITURE / FINISHING

-  0001 > VERNICIATO ALLUMINIO OPACO
VARNISHED ALUMINIUM MATT
-  0002 > CROMO LUCIDO
POLISHED CHROME
-  0003 > NICHEL SATINATO
NICKEL SATINED

LINEA DESIGN

SERIE 144 - 185



WMN144.128

WMN185.128

FINITURE / FINISHING

-  0001 > VERNICIATO ALLUMINIO OPACO
VARNISHED ALUMINIUM MATT
-  0003 > NICHEL SATINATO
NICKEL SATINED



WMN144.128

128	182	35	24



WMN185.128

128	150	25	16



WMN212.128

LINEA DESIGN

SERIE 112 - 212



WMN112.160

FINITURE / FINISHING

-  0001 > VERNICIATO ALLUMINIO OPACO
VARNISHED ALUMINIUM MATT
-  0003 > NICHEL SATINATO
NICKEL SATINED



WMN212.128

128	163	28	17



WMN112.160

160	180	25	20



WMN105.128



WMN163.160

LINEA
DESIGN

SERIE 105 - 163



FINITURE / FINISHING

-  0001 > VERNICIATO ALLUMINIO OPACO
VARNISHED ALUMINIUM MATT
-  0003 > NICHEL SATINATO
NICKEL SATINED



WMN105.128

128	156	32	22

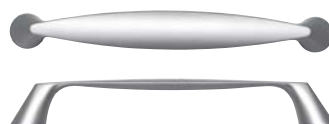

WMN163.160

160	195	26	22



WMN183.128



WMN183.096

LINEA
DESIGN

SERIE 183



FINITURE / FINISHING

-  0001 > VERNICIATO ALLUMINIO OPACO
VARNISHED ALUMINIUM MATT
-  0003 > NICHEL SATINATO
NICKEL SATINED



WMN183.128

WMN183.096

128	166	24	12
96	134	24	12

LINEA
DESIGN

SERIE 165



WMN165.160

FINITURE / FINISHING



0001 > VERNICIATO ALLUMINIO OPACO
VARNISHED ALUMINIUM MATT

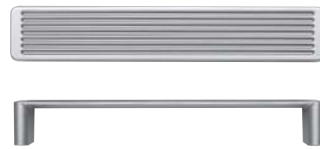

WMN165.160

160	168	24	30

LINEA
DESIGN

SERIE 166



WMN166.128

FINITURE / FINISHING



0001 > VERNICIATO ALLUMINIO OPACO
VARNISHED ALUMINIUM MATT

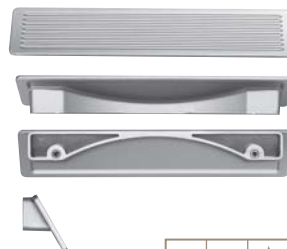

WMN166.128

128	180	26	32



WMN192.160

LINEA DESIGN

SERIE 192



WMN192.160

160	224	27	24

FINITURE / FINISHING

-  0001 > VERNICIATO ALLUMINIO OPACO
VARNISHED ALUMINIUM MATT
-  0003 > NICHEL SATINATO
NICKEL SATINED



WMN162.160

LINEA DESIGN

SERIE 162

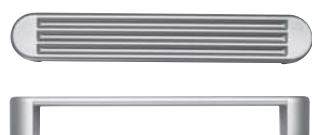

WMN162.160

160	184	25	30

FINITURE / FINISHING

-  0001 > VERNICIATO ALLUMINIO OPACO
VARNISHED ALUMINIUM MATT
-  0003 > NICHEL SATINATO
NICKEL SATINED

LINEA DESIGN

SERIE 124



WMN124.128



WMN124.096

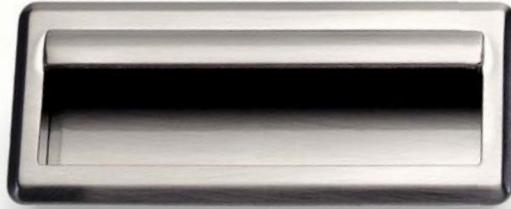

WMN124.064



FINITURE / FINISHING

-  0001 > VERNICIATO ALLUMINIO OPACO
VARNISHED ALUMINIUM MATT
-  0003 > NICHEL SATINATO
NICKEL SATINED

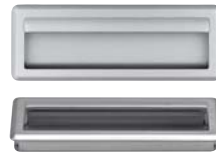

	⌀	↔	↑	↓
WMN124.128	128	138	19(13)	50
WMN124.096	96	106	19(13)	50
WMN124.064	64	74	19(13)	50

LINEA DESIGN

SERIE 170



WMN170.160



FINITURE / FINISHING

-  0001 > VERNICIATO ALLUMINIO OPACO
VARNISHED ALUMINIUM MATT



	⌀	↔	↑	↓
WMN170.160	160	180	18(13)	48



WMN5230/64



WMN5090/64

LINEA DESIGN

SERIE 5090 - 5230



WMN5090/64

64	85	22	25



WMN5230/64

64	90	19	27

FINITURE / FINISHING

- 0001 > VERNICIATO ALLUMINIO OPACO
VARNISHED ALUMINIUM MATT
- 00F7 > VERNICIATO NICHEL SATINATO
VARNISHED NICKEL SATINED

> WP0112.032
WP0112.064



WBC8180/00

WCH7112/46

LINEA DESIGN

SERIE P0112 - 7112 - 8180



WP0112.032
WP0112.064

32	42	22	8
64	74	22	8



WBC8180/00

-	25	-	60



WCH7112/46

46	34	59	6

FINITURE / FINISHING

- 0001 > VERNICIATO ALLUMINIO OPACO
VARNISHED ALUMINIUM MATT
- 00F7 > VERNICIATO NICHEL SATINATO
VARNISHED NICKEL SATINED

LINEA DESIGN

SERIE 150

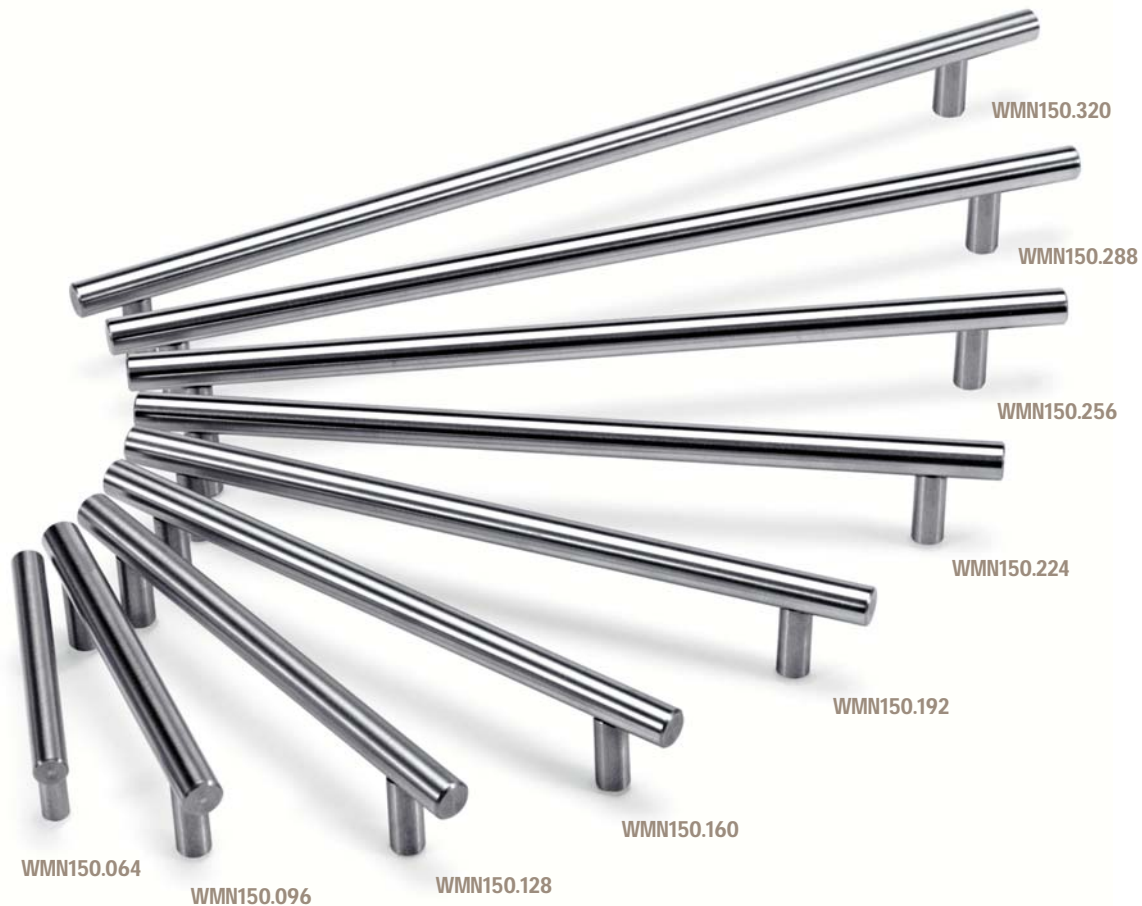

WMN150.064
WMN150.096
WMN150.128
WMN150.160
WMN150.192
WMN150.224
WMN150.256
WMN150.288
WMN150.320

⊕ ⊕	↔	↑	↓
64	94	33	10
96	126	35	12
128	170	35	12
160	203	35	12
192	235	35	12
224	266	35	12
256	298	35	12
288	330	35	12
320	362	35	12

WMN150.448
WMN150.640
WMN150.736

⊕ ⊕	↔	↑	↓
448	490	35	12
640	682	35	12
736	778	35	12



∅ 12

FINITURE / FINISHING



0006 > ACCIAIO INOX SATINATO
STAINLESS STEEL SATINED



WA0001.0192.AN

WA0001.0128.AN

WA0001.0096.AN

LINEA DESIGN

SERIE WA0001



	⌀	↔	↑	↓
WA0001.0096	96	146	38	18
WA0001.0128	128	178	38	18
WA0001.0160	160	210	38	18
WA0001.0192	192	242	38	18
WA0001.0224	224	274	38	18
WA0001.0320	320	370	38	18
WA0001.0448	448	498	38	18
WA0001.0640	640	690	38	18
WA0001.0736	736	786	38	18

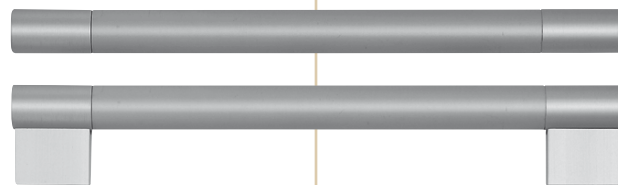

∅ 18

FINITURE / FINISHING



AN > ALLUMINIO ANODIZZATO
ALUMINIUM ANODIZED

LINEA DESIGN

SERIE 200 - 201
202 - 203



WP0200.025



WP0200.021



WP0200.016



WP0201.030



WP0201.027



WP0201.022



WP0202.028



WP0202.024



WP0202.019



WP0203.021



WP0203.017



WP0203.014



WP0200.025
WP0200.021
WP0200.016

⊕	↔	↑	∅
-	-	22	25
-	-	21	21
-	-	20	16



WP0201.030
WP0201.027
WP0201.022

⊕	↔	↑	∅
-	-	31	30
-	-	28	27
-	-	23	22



WP0202.028
WP0202.024
WP0202.019

⊕	↔	↑	∅
-	-	25	28
-	-	24	24
-	-	23	19



WP0203.021
WP0203.017
WP0203.014

⊕	↔	↑	∅
-	-	28	21
-	-	25	17
-	-	22	14

FINITURE / FINISHING

-  0001 > VERNICIATO ALLUMINIO OPACO
VARNISHED ALUMINIUM MATT
-  0002 > CROMO LUCIDO
POLISHED CHROME
-  0003 > NICHEL SATINATO
NICKEL SATINED



WPO208.020



WPO208.015



WPO209.014



WPO206.014



WPO205.014



WPO204.018



WPO207.013



WPO210.009



WPO211.012

LINEA DESIGN

SERIE 204 - 205
206 - 207 - 208
209 - 210 - 211



-	-	29	20

WPO208.020

WPO208.015



-	-	25	14

WPO209.014



-	16	28	14

WPO206.014



-	20	26	14

WPO205.014



-	-	25	18

WPO204.018



-	-	29	13

WPO207.013



-	13	20	9

WPO210.009



-	-	21	12

WPO211.012

FINITURE / FINISHING

- 0001 > VERNICIATO ALLUMINIO OPACO
VARNISHED ALUMINIUM MATT
- 0002 > CROMO LUCIDO
POLISHED CHROME
- 0003 > NICHEL SATINATO
NICKEL SATINED

LINEA DESIGN

SERIE 2024 - 2025
6008 - 6016



WP02024/35
WP02024/30
WP02024/25

⊕	↔	↑	∅
-	-	27	35
-	-	24	30
-	-	21	25



WP02025/35
WP02025/30
WP02025/25

⊕	↔	↑	∅
-	-	28	35
-	-	25	30
-	-	22	25



WP06008/31
WP06008/24

⊕	↔	↑	∅
-	-	27	31
-	-	20	24



WP06016/00

⊕	↔	↑	↓
-	36	19	27

FINITURE / FINISHING



0001 > VERNICIATO ALLUMINIO OPACO
VARNISHED ALUMINIUM MATT



00F7 > VERNICIATO NICHEL SATINATO
VARNISHED NICKEL SATINED



WPO6002/31



WPO6002/28



WPO6002/22



WPO6002/18



WPO6000/30



WPO6000/24

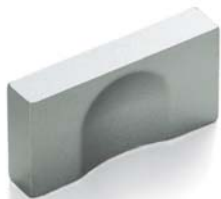

> WPO112.032
WPO112.064



WPO111.000

LINEA DESIGN

SERIE 6000 - 6002
111 - 112



WPO6002/31
WPO6002/28
WPO6002/22
WPO6002/18

⊕	↔	↑	∅
-	-	22	31
-	-	20	28
-	-	18	22
-	-	15	18



WPO6000/30
WPO6000/24

⊕	↔	↑	∅
-	-	21	30
-	-	20	24

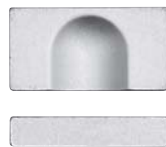

WPO112.032
WPO112.064

⊕	↔	↑	↓
32	42	22	8
64	74	22	8



WPO111.000

⊕	↔	↑	↓
-	30	16	15

FINITURE / FINISHING

- 0001 > VERNICIATO ALLUMINIO OPACO
VARNISHED ALUMINIUM MATT
- 00F7 > VERNICIATO NICHEL SATINATO
VARNISHED NICKEL SATINED





Decor

FINITURE LINEA DECOR

DECOR FINISHES

 00H1 > VERNICIATO BIANCO LUCIDO VARNISHED SHINY WHITE	 00F7 > VERNICIATO NICHEL SATINATO VARNISHED NICKEL SATINED	 00R3 > ARGENTO NOTTINGHAM NOTTINGHAM SILVER
 00M2 > LACCATO AVORIO LUCIDO SHINY IVORY	 00M1 > NICHEL LUCIDO POLISHED NICKEL	 00T4 > BIANCO VINTAGE ARGENTO WHITE VINTAGE SILVER
 00N9 > LACCATO MADREPERLA MOTHER OF PEARL	 00O2 > CROMO LUCIDO POLISHED CHROME	 00M5 > ARGENTO VENEZIA VENETIAN SILVER
 00O1 > VERNICIATO ALLUMINIO OPACO VARNISHED ALUMINIUM MATT	 00SP > PLACCATO ARGENTO SILVER PLATED	 00D5 > ARGENTO GRAFFIATO SCRATCHED SILVER

 0015 > ARGENTO VECCHIO OLD SILVER	 0020 > FORGIA ANTICA ANTIQUE FORGE	 00T5 > AVORIO VINTAGE ORO IVORY VINTAGE GOLD
 00E8 > ARGENTO VECCHIO BRILLANTE SHINY OLD SILVER	 0021 > FORGIA ANTICA LUCIDA SHINY ANTIQUE FORGE	 00R8 > ORO MILANO MILANO GOLD
 0024 > NICHEL VECCHIO OLD NICKEL	 00C1 > RAME ANTICO COUNTRY ANTIQUE COPPER COUNTRY	 00R4 > ORO ROMA ROMA GOLD
 00B9 > NICHEL VECCHIO COUNTRY OLD NICKEL COUNTRY	 0027 > RAME ANTICO ANTIQUE COPPER	 00GP > PLACCATO ORO GOLD PLATED

 00B8 > ORVAL MATT ORVAL MATT	 0011 > ANTICA ROMA ANTIQUE ROME	 00A6 > NERO ALPI BLACK ALPS
 00X4 > BRONZO PARIGI BRONZE PARIS	 00D1 > ANTICA FIRENZE ANTIQUE FLORENCE	 0059 > NERO LUCIDO SHINY BLACK
 00A8 > ORVAL ORVAL	 00B1 > BRONZO COUNTRY BRONZE COUNTRY	 00H2 > VERNICIATO NERO LUCIDO VARNISHED SHINY BLACK
 00A9 > PATINATO COUNTRY PATINATED COUNTRY	 00C2 > RUSTIKALL AVORIO RUSTIKALL IVORY	 00L8 > TOTAL BLACK NICHEL TOTAL BLACK NICKEL

SIMBOLOGIA

SYMBOLOLOGY



INTERASSE
DISTANCE BETWEEN CENTRES



ALTEZZA
HEIGHT



DIAMETRO
DIAMETER



LUNGHEZZA
LENGHT



LARGHEZZA
WIDTH



LUNGHEZZA CHIAVE
KEY LENGHT

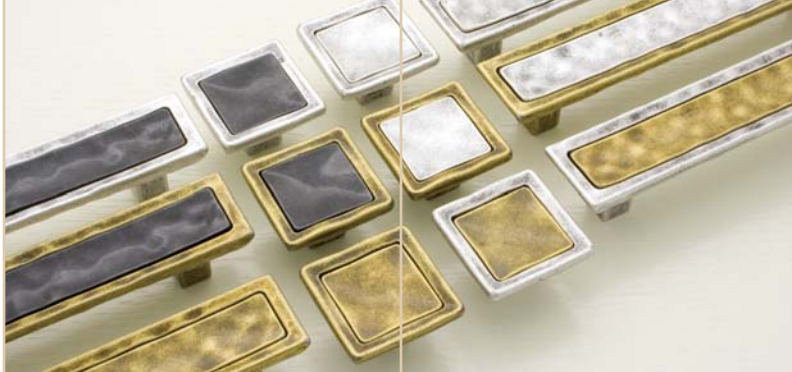

linea
Decor

SERIE 188 METAL



GIUSTI



WMN188.096



96	126	19	23

COMBINAZIONE COLORI / COLOUR-MATCHING

- D1 D1
BASE > D1 ANTIQUE FLORENCE
INSERT > D1 ANTIQUE FLORENCE
- E8 D1
BASE > D1 ANTIQUE FLORENCE
INSERT > E8 SHINY OLD SILVER
- 59 D1
BASE > D1 ANTIQUE FLORENCE
INSERT > 59 SHINY BLACK

WMN188.064



64	94	19	23

WPO188.000



-	31	19	31

- D1 E8
BASE > E8 SHINY OLD SILVER
INSERT > D1 ANTIQUE FLORENCE
- E8 E8
BASE > E8 SHINY OLD SILVER
INSERT > E8 SHINY OLD SILVER
- 59 E8
BASE > E8 SHINY OLD SILVER
INSERT > 59 SHINY BLACK

WBC188.000



-	21	-	41

> WCH7201/42
WCH7201/53



42	35	72	6
53	35	83	6

FINITURE / FINISHING

- 00D1 > ANTICA FIRENZE
ANTIQUÉ FLORENCE
- 00E8 > ARGENTO VECCHIO BRILLANTE
SHINY OLD SILVER
- 0059 > NERO LUCIDO
SHINY BLACK



linea
Decor

SERIE 616



GIUSTI

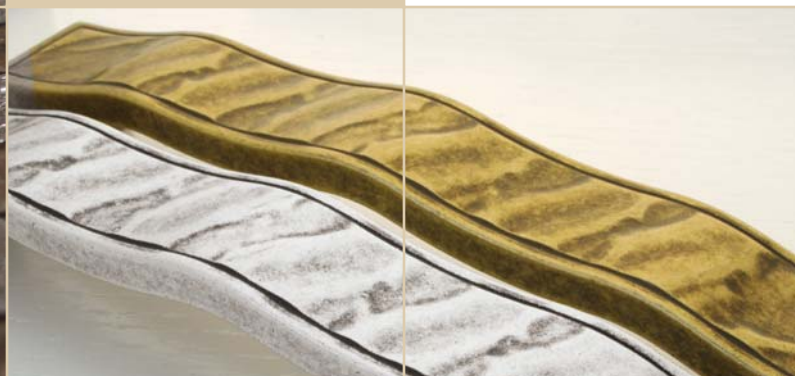
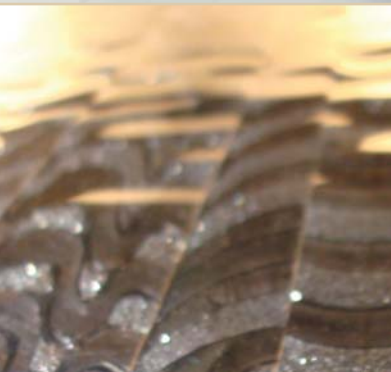

WMN616.128



128	138	25	20

WMN616.096



96	106	25	20

WP0616.032



32	42	23	20

FINITURE / FINISHING

00D1 > ANTICA FIRENZE
ANTIQUE FLORENCE

00T1 > ANTICA ROMA
ANTIQUE ROME

00A8 > ORVAL
ORVAL

00E8 > ARGENTO VECCHIO BRILLANTE
SHINY OLD SILVER

00O2 > CROMO LUCIDO
POLISHED CHROME

00Z1 > FORGIA ANTICA LUCIDA
SHINY ANTIQUE FORGE

linea
Decor

SERIE 612



GIUSTI

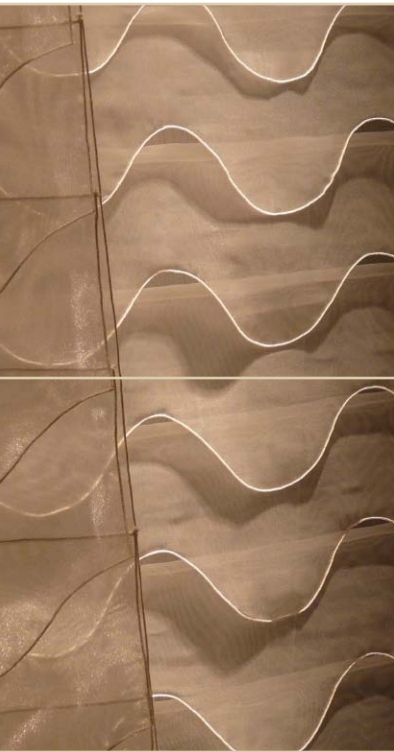

WMN612.128



128	138	25	20

WMN612.096



96	106	25	20

WP0612.032



32	42	23	20

FINITURE / FINISHING

00D1 > ANTICA FIRENZE
ANTIQUE FLORENCE

0011 > ANTICA ROMA
ANTIQUE ROME

00A8 > ORVAL
ORVAL

00E8 > ARGENTO VECCHIO BRILLANTE
SHINY OLD SILVER

0002 > CROMO LUCIDO
POLISHED CHROME

0021 > FORGIA ANTICA LUCIDA
SHINY ANTIQUE FORGE

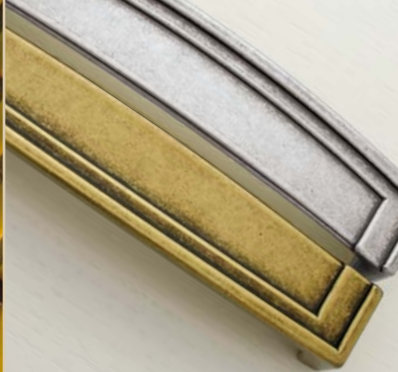
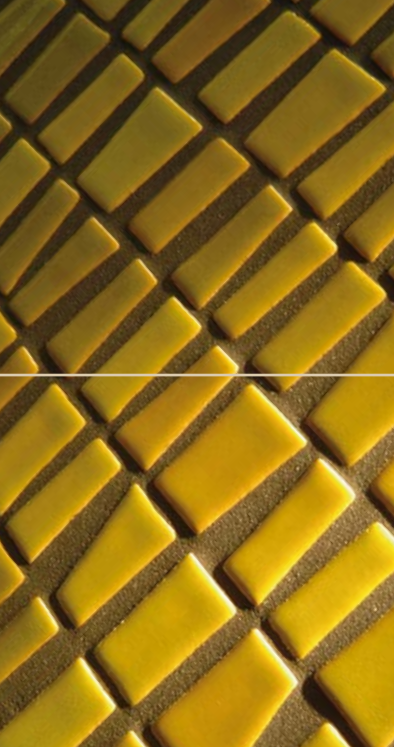

linea
Decor

SERIE 603-610



GIUSTI

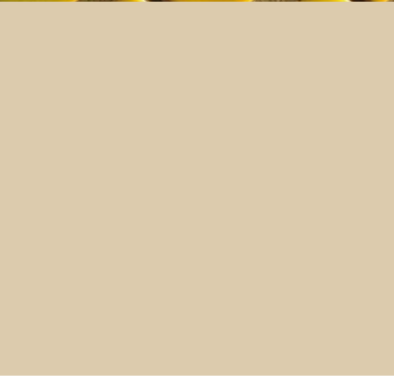

WMN603.128



⌀	↔	↑	↓
128	134	23	24

WMN603.096

WP0603.032

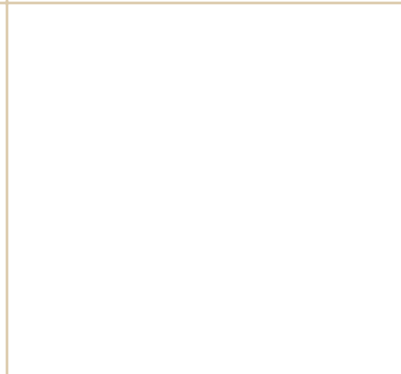
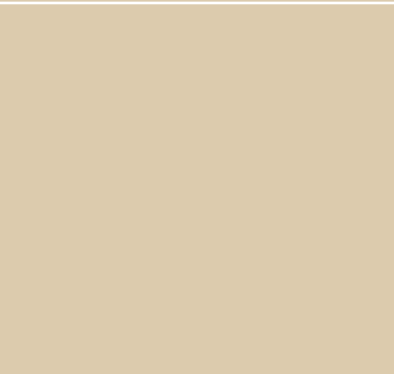

⌀	↔	↑	↓
96	112	23	24

⌀	↔	↑	↓
32	42	22	9

FINITURE / FINISHING

-  00D1 > ANTICA FIRENZE
ANTIQUE FLORENCE
-  00I1 > ANTICA ROMA
ANTIQUE ROME
-  00A8 > ORVAL
ORVAL
-  00E8 > ARGENTO VECCHIO BRILLANTE
SHINY OLD SILVER

WMN610.096

WBC603.000

> WCH603/42
WCH603/53

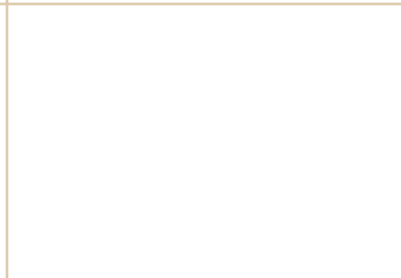

⌀	↔	↑	↓
96	110 (13)	37	

⌀	↔	↑	↓
-	25	-	49

↔	↑	↓	⌀
42	35	67	6
53	35	78	6



linea
Decor

SERIE 604



GIUSTI

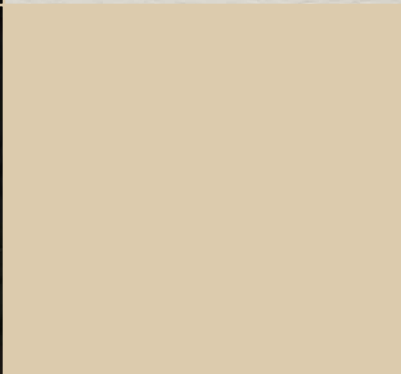

WMN604.128



128	172	25	26

WMN604.096



96	136	25	26

WP0604.032



32	50	19	24

FINITURE / FINISHING

- 00D1 > ANTICA FIRENZE
ANTIQUE FLORENCE
- 00I1 > ANTICA ROMA
ANTIQUE ROME
- 00A8 > ORVAL
ORVAL
- 00E8 > ARGENTO VECCHIO BRILLANTE
SHINY OLD SILVER



linea
Decor
SERIE 555

GIUSTI

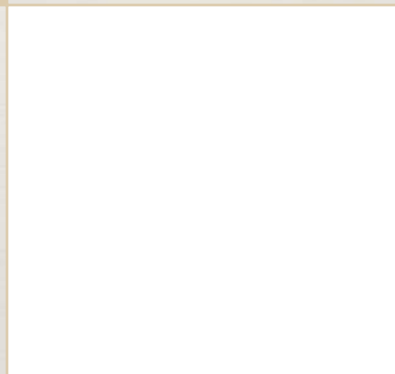
WMN555.160



			
160	171	30	11



WMN555.128



			
128	139	30	11

WMN555.096



			
96	107	30	11

FINITURE / FINISHING

-  00D1 > ANTICA FIRENZE
ANTIQUE FLORENCE
-  00I1 > ANTICA ROMA
ANTIQUE ROME
-  00A8 > ORVAL
ORVAL
-  00E8 > ARGENTO VECCHIO BRILLANTE
SHINY OLD SILVER



linea
Decor

SERIE 108-109



GIUSTI



> WMN108.192
WMN108.128



BARRA PIENA / FULL BAR

⊕ ⊕	↔	⊥	⊕ ⊕
192	204	20	13
128	139	20	13

> WMN109.192
WMN109.128



BARRA LEGGERA / EMPTY BAR

⊕ ⊕	↔	⊥	⊕ ⊕
192	204	20	13
128	139	20	13

WP0111.000



⊕ ⊕	↔	⊥	⊕ ⊕
-	30	16	15

FINITURE / FINISHING

 00D1 > ANTICA FIRENZE
ANTIQUE FLORENCE

 0011 > ANTICA ROMA
ANTIQUE ROME

 00A8 > ORVAL
ORVAL

 00E8 > ARGENTO VECCHIO BRILLANTE
SHINY OLD SILVER

 00O1 > VERNICIATO ALLUMINIO OPACO
VARNISHED ALUMINIUM MATT

 00F7 > VERNICIATO NICHEL SATINATO
VARNISHED NICKEL SATINED



linea
Decor

SERIE 601



GIUSTI

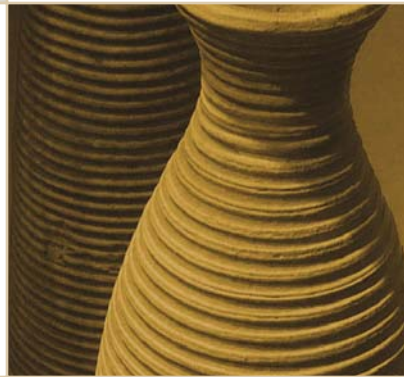

WMN601.128



128	164	23	25

WP0601.032



32	46	23	40

FINITURE / FINISHING

00D1 > ANTICA FIRENZE
ANTIQUE FLORENCE

00T1 > ANTICA ROMA
ANTIQUE ROME

00A8 > ORVAL
ORVAL

00E8 > ARGENTO VECCHIO BRILLANTE
SHINY OLD SILVER

00Z0 > FORGIA ANTICA OPACO
ANTIQUE FORGE MATT

00Z1 > FORGIA ANTICA LUCIDA
SHINY ANTIQUE FORGE

linea
Decor

SERIE 609



GIUSTI

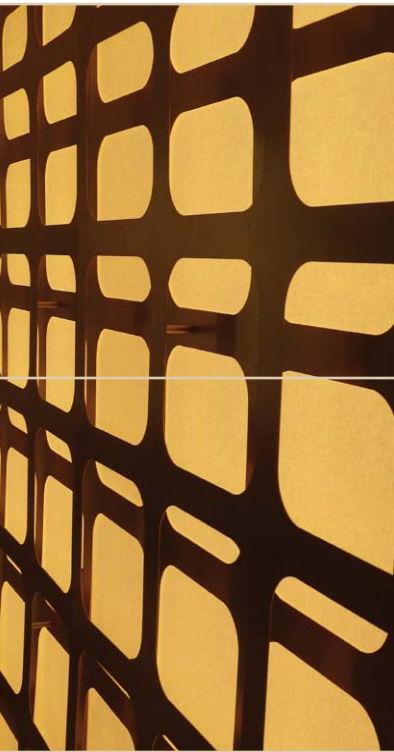

WMN609.192

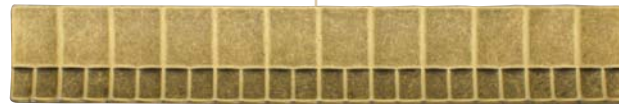

192	200	22	38

WMN609.128



128	136	22	38

WMN609.064



64	72	22	38

WBC8201

> WCH7201/42
WCH7201/53



-	24	-	37

42	35	72	6
53	35	83	6

WMN609.V64



64	18	24	110

WMN609.V32



32	24	20	58

FINITURE / FINISHING

- OOD1 > ANTICA FIRENZE
ANTIQUE FLORENCE
- O011 > ANTICA ROMA
ANTIQUE ROME
- O0A8 > ORVAL
ORVAL
- OOE8 > ARGENTO VECCHIO BRILLANTE
SHINY OLD SILVER



linea
Decor

SERIE 650



GIUSTI



WMN650.096



96	113	27	64

WMN650.064



64	87	24	57

WMN650.032



32	50	24	47

FINITURE / FINISHING

- 00D1 > ANTICA FIRENZE
ANTIQUE FLORENCE
- 00A8 > ORVAL
ORVAL
- 00GP > PLACCATO ORO
GOLD PLATED
- 00E8 > ARGENTO VECCHIO BRILLANTE
SHINY OLD SILVER
- 0002 > CROMO LUCIDO
POLISHED CHROME
- 00F7 > VERNICIATO NICHEL SATINATO
VARNISHED NICKEL SATINED

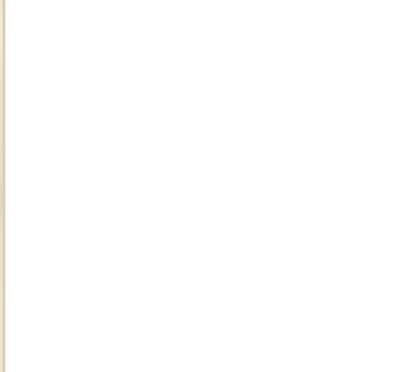
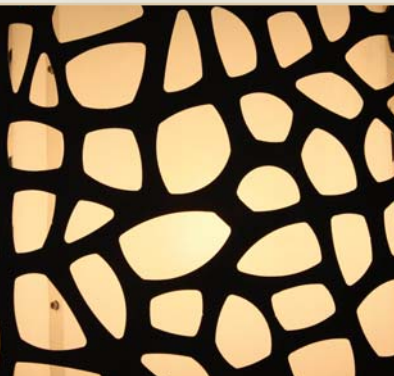

linea
Decor
SERIE 651

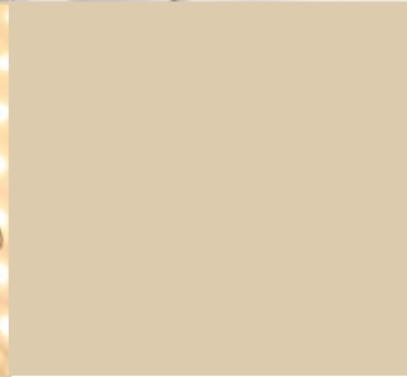
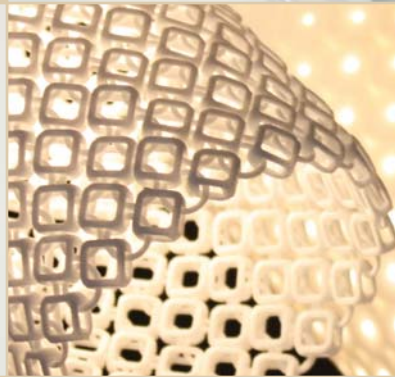

GIUSTI

WMN651.064



64	115	26	58	

WMN651.032



32	80	26	56	

WP0651.032



32	46	23	35	

FINITURE / FINISHING

 OOD1 > ANTICA FIRENZE
ANTIQUE FLORENCE

 OOAB > ORVAL
ORVAL

 OOGP > PLACCATO ORO
GOLD PLATED

 OOE8 > ARGENTO VECCHIO BRILLANTE
SHINY OLD SILVER

 OO02 > CROMO LUCIDO
POLISHED CHROME

 OOF7 > VERNICIATO NICHEL SATINATO
VARNISHED NICKEL SATINED



linea
Decor

SERIE 640



GIUSTI

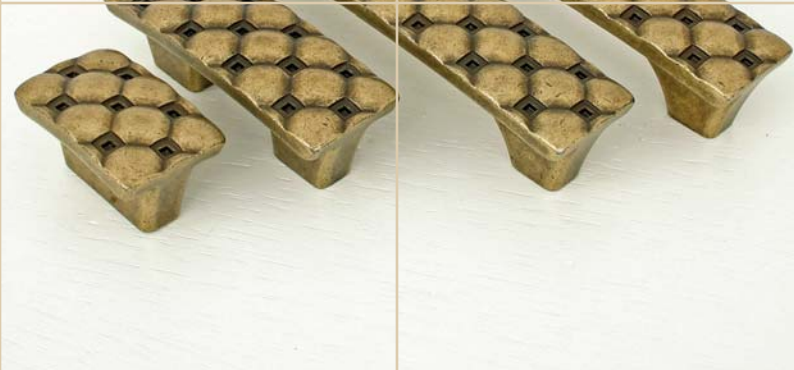

WMN640.128



ϕ	\leftrightarrow	\updownarrow	\updownarrow
128	150	25	22

WMN640.096



ϕ	\leftrightarrow	\updownarrow	\updownarrow
96	121	25	22

FINITURE / FINISHING

-  00D1 > ANTICA FIRENZE
ANTIQUE FLORENCE
-  00A8 > ORVAL
ORVAL

-  00GP > PLACCATO ORO
GOLD PLATED
-  00E8 > ARGENTO VECCHIO BRILLANTE
SHINY OLD SILVER
-  0002 > CROMO LUCIDO
POLISHED CHROME
-  0003 > NICHEL SATINATO
NICKEL SATINED
-  00L8 > TOTAL BLACK NICHEL
TOTAL BLACK NICKEL

WP0640.032



ϕ	\leftrightarrow	\updownarrow	\updownarrow
32	65	23	22

WP0640.016



ϕ	\leftrightarrow	\updownarrow	\updownarrow
(16)	37	21	22



linea
Decor

SERIE 605



GIUSTI

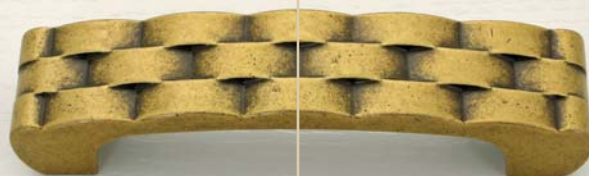

WMN605.128

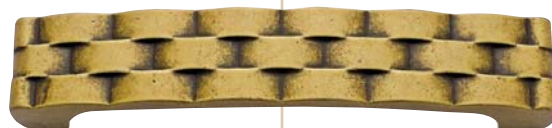

128	150	25	24

WMN605.096

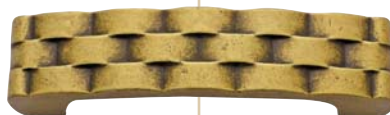

96	114	25	24

WMN605.064

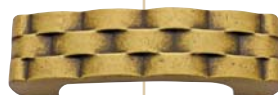

64	82	24	24

FINITURE / FINISHING

- 00D1 > ANTICA FIRENZE
ANTIQUE FLORENCE
- 00I1 > ANTICA ROMA
ANTIQUE ROME
- 00A8 > ORVAL
ORVAL
- 00E8 > ARGENTO VECCHIO BRILLANTE
SHINY OLD SILVER



linea
Decor
SERIE 552-554

GIUSTI

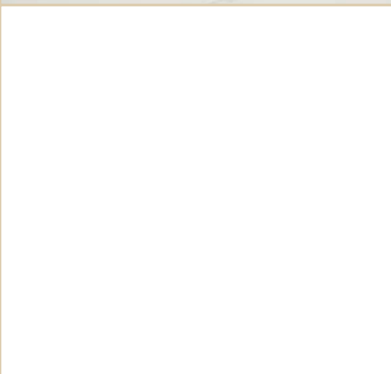
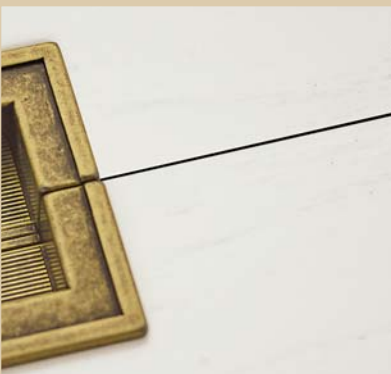

WMN554.128



128	144	(15)	32

WMN552.128



128	144	(15)	39

WMN554.096



96	112	(15)	32

WMN552.096



96	112	(13)	39

FINITURE / FINISHING

- OOD1 > ANTICA FIRENZE
ANTIQUE FLORENCE
- OOA8 > ORVAL
ORVAL
- OOE8 > ARGENTO VECCHIO BRILLANTE
SHINY OLD SILVER

WMN554.032



32	48	(15)	32

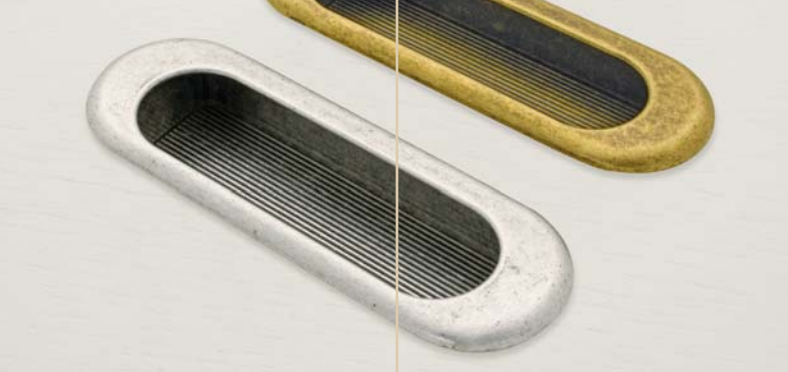

linea
Decor
SERIE 540-541-542-543-900

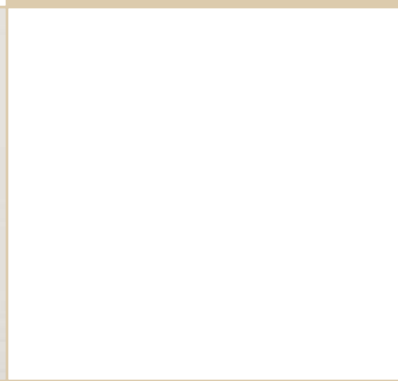

GIUSTI

WMN540.075

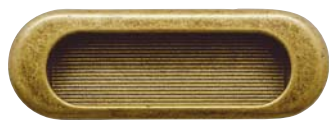

⌀	↔	↑	↓
75	90	(12)	31

WMN542.075



⌀	↔	↑	↓
75	90	(12)	31

WMN541.064



⌀	↔	↑	↓
64	26	(8)	78

> WMN543.064
WMN543.096



⌀	↔	↑	↓
64	26	(10)	84
96	35	(13)	124

WMN900.128



⌀	↔	↑	↓
128	137	(14)	30

FINITURE / FINISHING

 00D1 > ANTICA FIRENZE
ANTIQUE FLORENCE

 0011 > ANTICA ROMA
ANTIQUE ROME

 00A8 > ORVAL
ORVAL

 00E8 > ARGENTO VECCHIO BRILLANTE
SHINY OLD SILVER

 00O1 > VERNICIATO ALLUMINIO OPACO
VARNISHED ALUMINIUM MATT

 00F7 > VERNICIATO NICHEL SATINATO
VARNISHED NICKEL SATINED



linea
Decor

SERIE 611



GIUSTI



WMN611.128



128	153	28	28

WMN611.096



96	121	28	25

WMN611.032



32	47	20	20

FINITURE / FINISHING

- OOD1 > ANTICA FIRENZE
ANTIQUE FLORENCE
- OOA8 > ORVAL
ORVAL
- OOE8 > ARGENTO VECCHIO BRILLANTE
SHINY OLD SILVER
- OOF7 > VERNICIATO NICHEL SATINATO
VARNISHED NICKEL SATINATED



linea
Decor

SERIE 628



GIUSTI



WMN628.224



224	255	28	27

WMN628.128



128	160	28	27

WMN628.096



96	128	25	25

WP0628.000



-	34	24	34

FINITURE / FINISHING

- OOD1 > ANTICA FIRENZE
ANTIQUE FLORENCE
- 00A8 > ORVAL
ORVAL
- 00E8 > ARGENTO VECCHIO BRILLANTE
SHINY OLD SILVER
- 00F7 > VERNICIATO NICHEL SATINATO
VARNISHED NICKEL SATINED



linea
Decor

SERIE 652



GIUSTI



WMN652.128



128	169	25	26

WMN652.096



96	128	23	24

WP0652.035



-	35	21	35

FINITURE / FINISHING

00D1 > ANTICA FIRENZE
ANTIQUE FLORENCE

00A8 > ORVAL
ORVAL

00E8 > ARGENTO VECCHIO BRILLANTE
SHINY OLD SILVER

0002 > CROMO LUCIDO
POLISHED CHROME

00F7 > VERNICIATO NICHEL SATINATO
VARNISHED NICKEL SATINED



linea
Decor

SERIE 503



GIUSTI

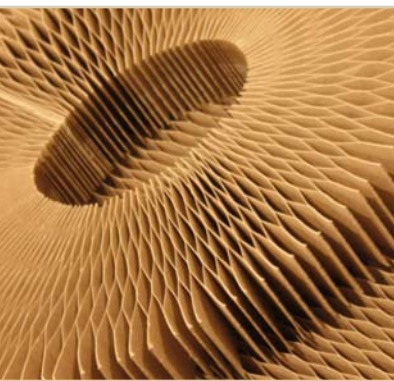

WMN503.128



128	165	27	26

WMN503.096



96	129	21	21

WP0503.000



-	44	25	23

FINITURE / FINISHING

- 00D1 > ANTICA FIRENZE
ANTIQUE FLORENCE
- 00I1 > ANTICA ROMA
ANTIQUE ROME
- 00A8 > ORVAL
ORVAL

- 00E8 > ARGENTO VECCHIO BRILLANTE
SHINY OLD SILVER
- 00F7 > VERNICIATO NICHEL SATINATO
VARNISHED NICKEL SATINED
- 0024 > NICHEL VECCHIO
OLD NICKEL
- 0027 > RAME ANTICO
ANTIQUE COPPER
- 00C2 > RUSTIKALL AVORIO
RUSTIKALL IVORY



linea
Decor

SERIE 622



GIUSTI



WMN622.ASX

WMN622.ADX



128	186	30	30

128	186	30	30

WMN622.BSX

WMN622.BDX



96	146	27	30

96	146	27	30

FINITURE / FINISHING

00D1 > ANTICA FIRENZE
ANTIQUE FLORENCE

00T1 > ANTICA ROMA
ANTIQUE ROME

00A8 > ORVAL
ORVAL

00E8 > ARGENTO VECCHIO BRILLANTE
SHINY OLD SILVER

00O2 > CROMO LUCIDO
POLISHED CHROME

00F7 > VERNICIATO NICHEL SATINATO
VARNISHED NICKEL SATINED

WBC622.000

WP0622.032



-	22	-	42

32	46	21	26



linea
Decor

SERIE 607



GIUSTI

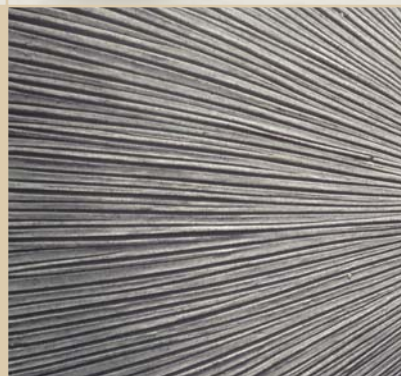

WMN607.128



128	146	25	28

WMN607.096



96	114	25	26

WMN607.064



64	82	25	25

WBC8201



-	24	-	37

> WCH7201/42
WCH7201/53



42	35	72	6
53	35	83	6

FINITURE / FINISHING

00D1 > ANTICA FIRENZE
ANTIQUE FLORENCE

0011 > ANTICA ROMA
ANTIQUE ROME

00A8 > ORVAL
ORVAL

00E8 > ARGENTO VECCHIO BRILLANTE
SHINY OLD SILVER

00F7 > VERNICIATO NICHEL SATINATO
VARNISHED NICKEL SATINED



linea
Decor

SERIE 619



GIUSTI

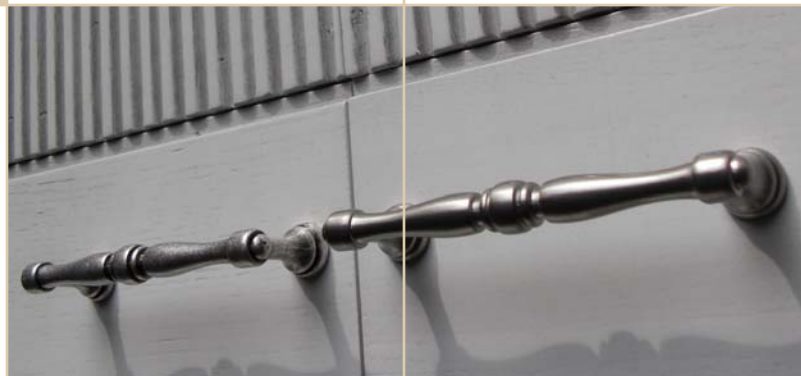

WMN619.128



128	144	32	16

WMN619.096

WP02025/35



96	112	31	16

-	35	28	35

FINITURE / FINISHING

-  OOD1 > ANTICA FIRENZE
ANTIQUE FLORENCE
-  OOA8 > ORVAL
ORVAL
-  OOE8 > ARGENTO VECCHIO BRILLANTE
SHINY OLD SILVER
-  OOF7 > VERNICIATO NICHEL SATINATO
VARNISHED NICKEL SATINED

WP02025/30

WP02025/25



-	30	25	30

-	25	22	25



linea
Decor

SERIE 654



GIUSTI



WMN654.160



160	180	25	16

WMN654.128



128	145	25	15

WMN654.096



96	113	24	14

FINITURE / FINISHING

-  OOD1 > ANTICA FIRENZE
ANTIQUE FLORENCE
-  OOA8 > ORVAL
ORVAL
-  OOGP > PLACCATO ORO
GOLD PLATED
-  OOE8 > ARGENTO VECCHIO BRILLANTE
SHINY OLD SILVER
-  OOO2 > CROMO LUCIDO
POLISHED CHROME
-  OOF7 > VERNICIATO NICHEL SATINATO
VARNISHED NICKEL SATINED



linea
Decor

SERIE 5500



GIUSTI



WMN5500/AS

WMN5500/AD



⌀	↔	↑	↓
96	132	20	48

⌀	↔	↑	↓
96	132	20	48

WMN5500/BS

WMN5500/BD



⌀	↔	↑	↓
64	95	20	39

⌀	↔	↑	↓
64	95	20	39

FINITURE / FINISHING

 00D1 > ANTICA FIRENZE
ANTIQUE FLORENCE

 00A8 > ORVAL
ORVAL

 00GP > PLACCATO ORO
GOLD PLATED

 00D5 > ARGENTO GRAFFIATO
SCRATCHED SILVER

 0002 > CROMO LUCIDO
POLISHED CHROME

 00F7 > VERNICIATO NICHEL SATINATO
VARNISHED NICKEL SATINED

WP06200/32

WP06200/23

WBC8200

> WCH7200/42
WCH7200/53



⌀	↔	↑	⌀
-	-	20	32

⌀	↔	↑	⌀
-	-	18	23

⌀	↔	↑	↓
-	25	-	55

┌	↔	↓	⌀
42	25	70	6
53	25	81	6



linea
Decor

SERIE 653



GIUSTI



WMN653.ASX

WMN653.ADX



⊕	↔	↑	↓
160	176	24	45

⊕	↔	↑	↓
160	176	24	45

WMN653.BSX

WMN653.BDX



⊕	↔	↑	↓
128	140	24	36

⊕	↔	↑	↓
128	140	24	36

WMN653.CSX

WMN653.CDX



⊕	↔	↑	↓
96	110	24	30

⊕	↔	↑	↓
96	110	24	30

FINITURE / FINISHING

 OOD1 > ANTICA FIRENZE
ANTIQUE FLORENCE

 OOA8 > ORVAL
ORVAL

 OOGP > PLACCATO ORO
GOLD PLATED

 OOE8 > ARGENTO VECCHIO BRILLANTE
SHINY OLD SILVER

 OOO2 > CROMO LUCIDO
POLISHED CHROME

 OOF7 > VERNICIATO NICHEL SATINATO
VARNISHED NICKEL SATINATED



linea
Decor

SERIE 602



GIUSTI



WMN602.128



128	148	22	40

WMN602.096



96	116	21	32

WP0602.030



-	-	20	30

FINITURE / FINISHING

- 00D1 > ANTICA FIRENZE
ANTIQUE FLORENCE
- 00T1 > ANTICA ROMA
ANTIQUE ROME

- 00A8 > ORVAL
ORVAL
- 00GP > PLACCATO ORO
GOLD PLATED
- 00D5 > ARGENTO GRAFFIATO
SCRATCHED SILVER
- 00O2 > CROMO LUCIDO
POLISHED CHROME
- 00F7 > VERNICIATO NICHEL SATINATO
VARNISHED NICKEL SATINATED

WBC602.096



96	32	-	115

WBC8037/SP



-	20	-	44

> WCH7200/42
> WCH7200/53



42	25	70	6
53	25	81	6



linea
Decor

SERIE 660



GIUSTI



WMN660.ASX

WMN660.ADX

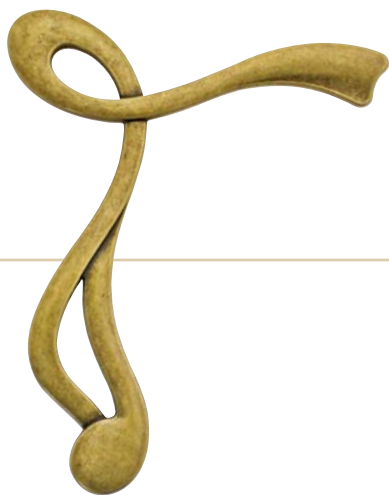

(3x)	133	24	166

(3x)	133	24	166

FINITURE / FINISHING

- 00D1 > ANTICA FIRENZE
ANTIQUE FLORENCE
- 00I1 > ANTICA ROMA
ANTIQUE ROME

- 00A8 > ORVAL
ORVAL
- 00GP > PLACCATO ORO
GOLD PLATED
- 00D5 > ARGENTO GRAFFIATO
SCRATCHED SILVER
- 00O2 > CROMO LUCIDO
POLISHED CHROME
- 00F7 > VERNICIATO NICHEL SATINATO
VARNISHED NICKEL SATINED



linea
Decor

SERIE 637



GIUSTI



WMN637.160



⌀	↔	↑	↓
160	183	24	35

WMN637.128



⌀	↔	↑	↓
128	146	24	27

FINITURE / FINISHING

 00D1 > ANTICA FIRENZE
ANTIQUE FLORENCE

 00A8 > ORVAL
ORVAL

 00GP > PLACCATO ORO
GOLD PLATED

 00E8 > ARGENTO VECCHIO BRILLANTE
SHINY OLD SILVER

 0002 > CROMO LUCIDO
POLISHED CHROME

 00F7 > VERNICIATO NICHEL SATINATO
VARNISHED NICKEL SATINED

WMN637.096



⌀	↔	↑	↓
96	109	23	21

WP0637.033



⌀	↔	↑	↓
-	31	21	37

linea
Decor

SERIE 614



GIUSTI



WP0602.030



⊕	↔	↑	⊘
-	-	20	30

WMN614.GSX



⊕	↔	↑	↑↓
128	165	22	36

WMN614.GDX



⊕	↔	↑	↑↓
128	165	22	36

WBC8037/SP

> WCH7200/42
WCH7200/53



⊕	↔	↑	↑↓
-	20	-	44

⊕	↔	↑	⊘
42	25	70	6
53	25	81	6

WMN614.S96



⊕	↔	↑	↑↓
96	124	22	30

WMN614.D96



⊕	↔	↑	↑↓
96	124	22	30

FINITURE / FINISHING

00D1 > ANTICA FIRENZE
ANTIQUE FLORENCE

00A8 > ORVAL
ORVAL

00GP > PLACCATO ORO
GOLD PLATED

00D5 > ARGENTO GRAFFIATO
SCRATCHED SILVER

0002 > CROMO LUCIDO
POLISHED CHROME

00F7 > VERNICIATO NICHEL SATINATO
VARNISHED NICKEL SATINED

WMN614.S64



⊕	↔	↑	↑↓
64	92	22	28

WMN614.D64



⊕	↔	↑	↑↓
64	92	22	28







linea
Decor
SERIE 646

GIUSTI







WMN646.096



			
96	136	25	32



WMN646.064



			
64	95	21	25

> WPO2032/35
WPO2032/30
WPO2032/25



			
-	35	23	35
-	30	21	30
-	25	19	25

FINITURE / FINISHING

 00D1 > ANTICA FIRENZE
ANTIQUE FLORENCE

 00A8 > ORVAL
ORVAL

 00GP > PLACCATO ORO
GOLD PLATED

 00E8 > ARGENTO VECCHIO BRILLANTE
SHINY OLD SILVER

 00O2 > CROMO LUCIDO
POLISHED CHROME

 00F7 > VERNICIATO NICHEL SATINATO
VARNISHED NICKEL SATINED

> WCH3020/42
WCH3020/52



			
42	29	78	6
52	29	87	6

WBC627.000



			
-	26	-	84



linea
Decor

SERIE 635



GIUSTI



WMN635.096



96	186	23	42

WMN635.064



64	145	21	32

WMN635.032



32	84	20	22

FINITURE / FINISHING

00D1 > ANTICA FIRENZE
ANTIQUE FLORENCE

00A8 > ORVAL
ORVAL

00GP > PLACCATO ORO
GOLD PLATED

00E8 > ARGENTO VECCHIO BRILLANTE
SHINY OLD SILVER

0002 > CROMO LUCIDO
POLISHED CHROME

00F7 > VERNICIATO NICHEL SATINATO
VARNISHED NICKEL SATINED

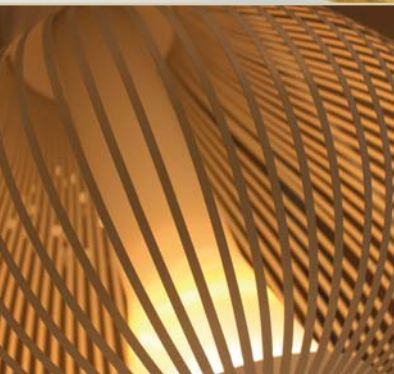

linea
Decor

SERIE 645



GIUSTI

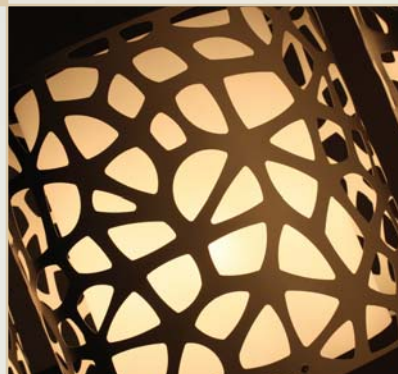

WMN645.128



128	159	25	31

WMN645.096



96	119	23	26

FINITURE / FINISHING

00D1 > ANTICA FIRENZE
ANTIQUE FLORENCE

00A8 > ORVAL
ORVAL

00E8 > ARGENTO VECCHIO BRILLANTE
SHINY OLD SILVER

0002 > CROMO LUCIDO
POLISHED CHROME

00F7 > VERNICIATO NICHEL SATINATO
VARNISHED NICKEL SATINED

WP0645.000



-	26	25	59

WP0645.035



-	35	26	35



linea
Decor

SERIE 645K



GIUSTI

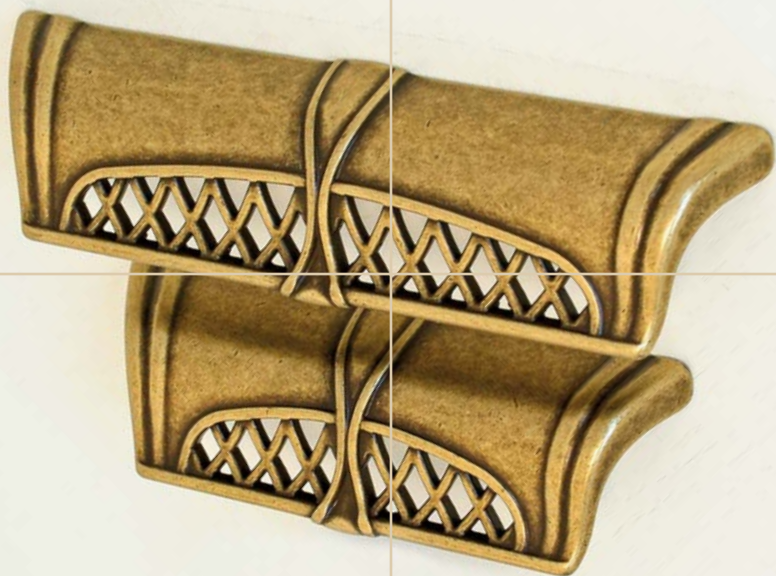

WMN645.K96



96	128	25	27

WMN645.K64



64	100	25	27

WP0645.035



-	35	26	35

FINITURE / FINISHING

- 00D1 > ANTICA FIRENZE
ANTIQUE FLORENCE
- 00A8 > ORVAL
ORVAL
- 00E8 > ARGENTO VECCHIO BRILLANTE
SHINY OLD SILVER
- 00O2 > CROMO LUCIDO
POLISHED CHROME
- 00F7 > VERNICIATO NICHEL SATINATO
VARNISHED NICKEL SATINATED



linea
Decor

SERIE 642



GIUSTI



WMN642.096



96	155	25	42

WMN642.064



64	120	25	42

WP0642.038



-	38	23	38

FINITURE / FINISHING

00D1 > ANTICA FIRENZE
ANTIQUE FLORENCE

00A8 > ORVAL
ORVAL

00GP > PLACCATO ORO
GOLD PLATED

00E8 > ARGENTO VECCHIO BRILLANTE
SHINY OLD SILVER

0002 > CROMO LUCIDO
POLISHED CHROME

00F7 > VERNICIATO NICHEL SATINATO
VARNISHED NICKEL SATINED

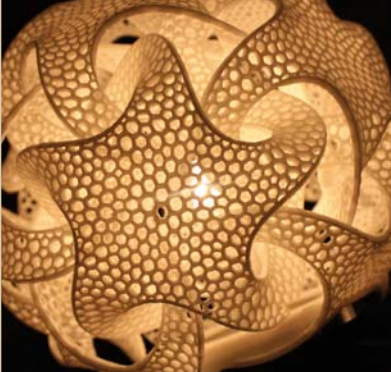

linea
Decor

SERIE 536-537



GIUSTI



WMN536.128



128	165	24	24

WMN536.096



96	130	22	21

WP0536.000



-	56	23	26

WMN537.064



64	80	19	31

FINITURE / FINISHING

00D1 > ANTICA FIRENZE
ANTIQUE FLORENCE

0011 > ANTICA ROMA
ANTIQUE ROME

00A8 > ORVAL
ORVAL

00E8 > ARGENTO VECCHIO BRILLANTE
SHINY OLD SILVER

00F7 > VERNICIATO NICHEL SATINATO
VARNISHED NICKEL SATINED

00C2 > RUSTIKALL AVORIO
RUSTIKALL IVORY



linea
Decor

SERIE 627



GIUSTI



WMN627.096



96	176	28	41

WMN627.064



> WPO2028/35
WPO2028/30
WPO2028/25



-	-	28	35
-	-	24	30
-	-	22	25

FINITURE / FINISHING

00D1 > ANTICA FIRENZE
ANTIQUE FLORENCE

00A8 > ORVAL
ORVAL

00E8 > ARGENTO VECCHIO BRILLANTE
SHINY OLD SILVER

00F7 > VERNICIATO NICHEL SATINATO
VARNISHED NICKEL SATINED

00H1 > VERNICIATO BIANCO LUCIDO
VARNISHED SHINY WHITE

00H2 > VERNICIATO NERO LUCIDO
VARNISHED SHINY BLACK

> WCH3020/42
WCH3020/52



42	29	78	6
52	29	87	6

WBC627.000



-	26	-	84



linea
Decor

SERIE 624



GIUSTI



WMN624.096



⊕	↔	↑	↓
96	172	24	39

WMN624.064



⊕	↔	↑	↓
64	129	22	30

WP0624.032



⊕	↔	↑	↓
32	79	24	42

WP0624.000



⊕	↔	↑	↓
-	63	23	33

WBC624.000



⊕	↔	↑	↓
-	34	-	63

WP0624.D40
WP0624.D29







⊕	↔	↑	∅
-	40	22	40
-	29	22	29

WMN624.075



⊕	↔	↑	↓
75	110	(12)	44

FINITURE / FINISHING

-  00D1 > ANTICA FIRENZE
ANTIQUE FLORENCE
-  00A8 > ORVAL
ORVAL
-  00E8 > ARGENTO VECCHIO BRILLANTE
SHINY OLD SILVER
-  00F7 > VERNICIATO NICHEL SATINATO
VARNISHED NICKEL SATINED



linea
Decor

SERIE 626



GIUSTI



WMN626.096

WMN626.064



⊕	↔	↑	↓
96	165	26	62

⊕	↔	↑	↓
64	122	22	44

WPO626.A32



WPO626.B32



⊕	↔	↑	↓
32	62	22	94

⊕	↔	↑	↓
32	44	21	72

FINITURE / FINISHING

-  OOD1 > ANTICA FIRENZE
ANTIQUE FLORENCE
-  OOA8 > ORVAL
ORVAL
-  OOE8 > ARGENTO VECCHIO BRILLANTE
SHINY OLD SILVER
-  OOF7 > VERNICIATO NICHEL SATINATO
VARNISHED NICKEL SATINED

WPO626.A64

WPO625.032

WBC626.000



⊕	↔	↑	↓
64	68	28	115

⊕	↔	↑	↓
32	52	20	38

⊕	↔	↑	↓
-	33	-	86



linea
Decor

SERIE 625



GIUSTI



WMN625.ASX

WMN625.ADX



⊕	↔	⊕	⊕
128	155	31	60

⊕	↔	⊕	⊕
128	155	31	60

WMN625.BSX

WMN625.BDX



⊕	↔	⊕	⊕
96	124	25	48

⊕	↔	⊕	⊕
96	124	25	48

WBC626.000

WPO625.032



⊕	↔	⊕	⊕
-	33	-	86

⊕	↔	⊕	⊕
32	52	20	38

FINITURE / FINISHING

-  00D1 > ANTICA FIRENZE
ANTIQUE FLORENCE
-  00A8 > ORVAL
ORVAL
-  00E8 > ARGENTO VECCHIO BRILLANTE
SHINY OLD SILVER
-  00F7 > VERNICIATO NICHEL SATINATO
VARNISHED NICKEL SATINED

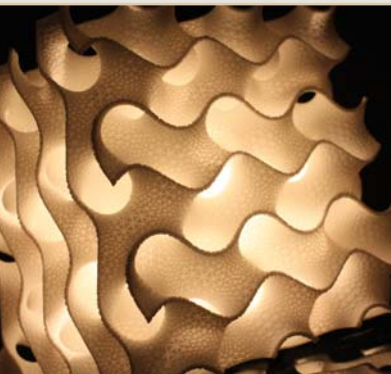
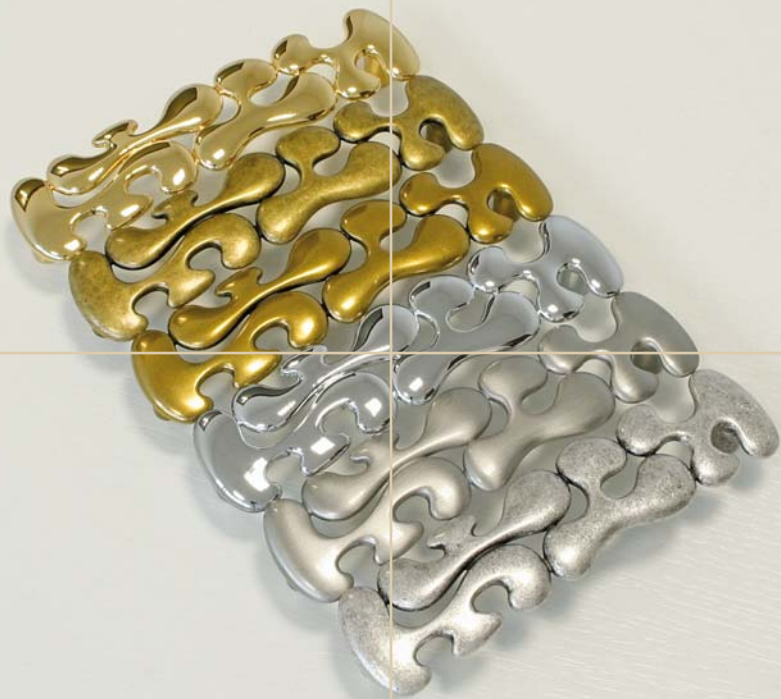

linea
Decor

SERIE 648



GIUSTI



WMN648.128



128	145	25	35

WP0648.032



32	55	25	55

WP0648.000



-	32	23	32

FINITURE / FINISHING

00D1 > ANTICA FIRENZE
ANTIQUE FLORENCE

00A8 > ORVAL
ORVAL

00GP > PLACCATO ORO
GOLD PLATED

00E8 > ARGENTO VECCHIO BRILLANTE
SHINY OLD SILVER

0002 > CROMO LUCIDO
POLISHED CHROME

00F7 > VERNICIATO NICHEL SATINATO
VARNISHED NICKEL SATINED



linea
Decor

SERIE 649



GIUSTI



WMN649.096



96	115	25	45

WP0649.042



-	42	23	42

FINITURE / FINISHING

-  OOD1 > ANTICA FIRENZE
ANTIQUE FLORENCE
-  OOAB > ORVAL
ORVAL
-  OOGP > PLACCATO ORO
GOLD PLATED
-  OOE8 > ARGENTO VECCHIO BRILLANTE
SHINY OLD SILVER
-  OO02 > CROMO LUCIDO
POLISHED CHROME
-  OOF7 > VERNICIATO NICHEL SATINATO
VARNISHED NICKEL SATINED



linea
Decor
SERIE 634





GIUSTI



WMN634.128



			
128	160	25	28





WMN634.096



			
96	121	23	21

WP0634.031



			
-	36	22	32

FINITURE / FINISHING

 00D1 > ANTICA FIRENZE
ANTIQUE FLORENCE

 00A8 > ORVAL
ORVAL

 00GP > PLACCATO ORO
GOLD PLATED

 00E8 > ARGENTO VECCHIO BRILLANTE
SHINY OLD SILVER

 0002 > CROMO LUCIDO
POLISHED CHROME

 00F7 > VERNICIATO NICHEL SATINATO
VARNISHED NICKEL SATINED



linea
Decor

SERIE 636



GIUSTI



WMN636.128



⊕ ⊕	↔	↑	↓
128	141	25	33

WMN636.096



⊕ ⊕	↔	↑	↓
96	107	23	25

WP0636.045



⊕ ⊕	↔	↑	↓
-	45	21	45

WP0636.031



⊕ ⊕	↔	↑	↓
-	31	20	31

FINITURE / FINISHING

 00D1 > ANTICA FIRENZE
ANTIQUE FLORENCE

 00A8 > ORVAL
ORVAL

 00GP > PLACCATO ORO
GOLD PLATED

 00E8 > ARGENTO VECCHIO BRILLANTE
SHINY OLD SILVER

 0002 > CROMO LUCIDO
POLISHED CHROME

 00F7 > VERNICIATO NICHEL SATINATO
VARNISHED NICKEL SATINED



linea
Decor

SERIE 615



GIUSTI

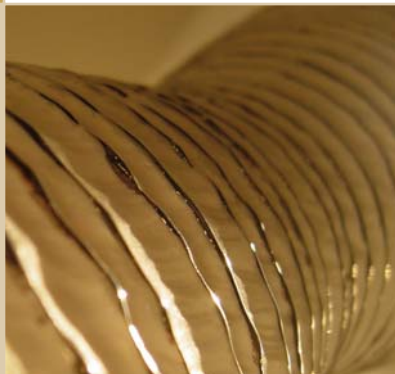

WMN615.096



96	120	24	20

WMN615.064



64	86	22	20

WMN615.032



32	54	20	20

FINITURE / FINISHING

- 00D1 > ANTICA FIRENZE
ANTIQUE FLORENCE
- 00A8 > ORVAL
ORVAL
- 00E8 > ARGENTO VECCHIO BRILLANTE
SHINY OLD SILVER
- 00F7 > VERNICIATO NICHEL SATINATO
VARNISHED NICKEL SATINED

WBC603.000



-	25	-	49

> WCH603/42
WCH603/53



42	35	67	6
53	35	78	6



linea
Decor

SERIE 647



GIUSTI



WMN647.128



128	180	25	42

WMN647.096



96	137	24	32

WPO647.036



-	36	22	36

FINITURE / FINISHING

OOD1 > ANTICA FIRENZE
ANTIQUE FLORENCE

OOAB > ORVAL
ORVAL

OOGP > PLACCATO ORO
GOLD PLATED

OOE8 > ARGENTO VECCHIO BRILLANTE
SHINY OLD SILVER

OO02 > CROMO LUCIDO
POLISHED CHROME

OOF7 > VERNICIATO NICHEL SATINATO
VARNISHED NICKEL SATINED

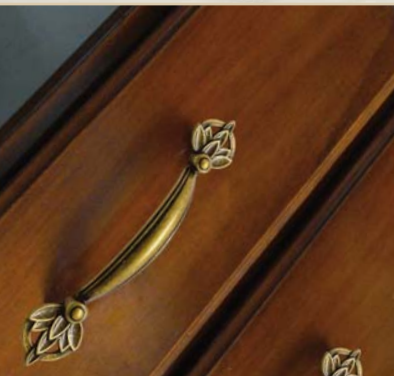

linea
Decor

SERIE 538



GIUSTI



WMN538.128





128	192	23	28

WMN538.096



96	160	23	28

FINITURE / FINISHING

-  OOD1 > ANTICA FIRENZE
ANTIQUE FLORENCE
-  OOA8 > ORVAL
ORVAL
-  OOE8 > ARGENTO VECCHIO BRILLANTE
SHINY OLD SILVER

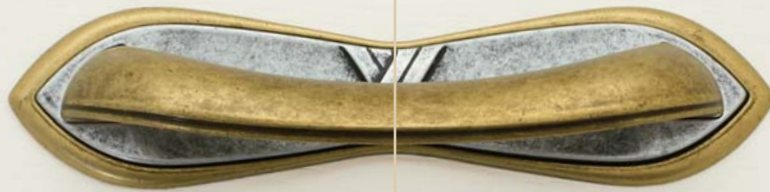

linea
Decor

SERIE 559



GIUSTI



WMN559.096



96	125	28	30

WMN559.064



64	93	24	27

COMBINAZIONE COLORI / COLOUR-MATCHING

-  D1 D1
BASE > D1 ANTIQUE FLORENCE
INSERT > D1 ANTIQUE FLORENCE
-  E8 E8
BASE > E8 SHINY OLD SILVER
INSERT > E8 SHINY OLD SILVER
-  E8 D1
BASE > D1 ANTIQUE FLORENCE
INSERT > E8 SHINY OLD SILVER
-  D1 E8
BASE > E8 SHINY OLD SILVER
INSERT > D1 ANTIQUE FLORENCE

FINITURE / FINISHING

-  OOD1 > ANTICA FIRENZE
ANTIQUÉ FLORENCE
-  OOE8 > ARGENTO VECCHIO BRILLANTE
SHINY OLD SILVER

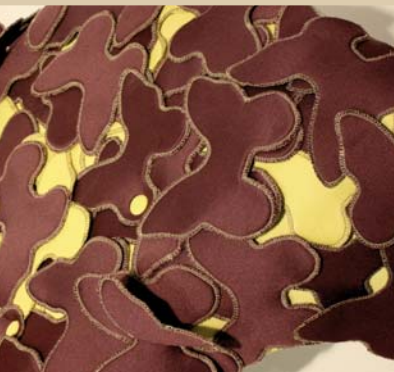

linea
Decor

SERIE 2032



GIUSTI



WP02032/35



-	35	23	35

WP02032/30



-	30	21	30

WP02032/25



-	25	19	25

FINITURE / FINISHING

00D1 > ANTICA FIRENZE
ANTIQUE FLORENCE

00A8 > ORVAL
ORVAL

00GP > PLACCATO ORO
GOLD PLATED

00E8 > ARGENTO VECCHIO BRILLANTE
SHINY OLD SILVER

00O2 > CROMO LUCIDO
POLISHED CHROME

00F7 > VERNICIATO NICHEL SATINATO
VARNISHED NICKEL SATINED



linea
Decor

SERIE 638-639



GIUSTI

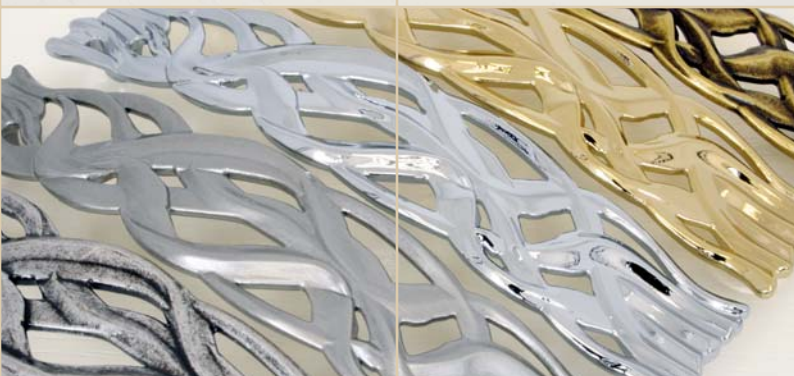

WMN638.128



128	146	24	30

WP0638.032



32	52	21	45

WMN639.128
WMN639.096

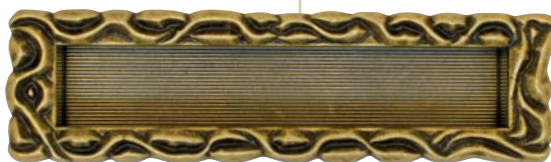

128	145 (15)	40	
96	112 (13)	39	

FINITURE / FINISHING

00D1 > ANTICA FIRENZE
ANTIQUE FLORENCE

00A8 > ORVAL
ORVAL

00GP > PLACCATO ORO
GOLD PLATED

00E8 > ARGENTO VECCHIO BRILLANTE
SHINY OLD SILVER

0002 > CROMO LUCIDO
POLISHED CHROME

00F7 > VERNICIATO NICHEL SATINATO
VARNISHED NICKEL SATINED



linea
Decor

SERIE 608



GIUSTI

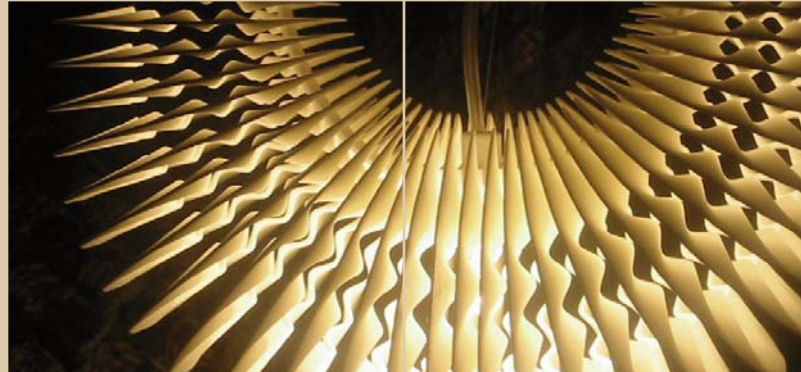

WMN608.128



ϕ	\leftrightarrow	\updownarrow	\updownarrow
128	140	23	50

WMN608.064



ϕ	\leftrightarrow	\updownarrow	\updownarrow
64	75	22	43

WP0608.064



ϕ	\leftrightarrow	\updownarrow	ϕ
64	74	20	74

WP0608.032



ϕ	\leftrightarrow	\updownarrow	ϕ
32	38	18	38

FINITURE / FINISHING

00D1 > ANTICA FIRENZE
ANTIQUÉ FLORENCE

00A8 > ORVAL
ORVAL

00GP > PLACCATO ORO
GOLD PLATED

00E8 > ARGENTO VECCHIO BRILLANTE
SHINY OLD SILVER

0002 > CROMO LUCIDO
POLISHED CHROME

00F7 > VERNICIATO NICHEL SATINATO
VARNISHED NICKEL SATINED



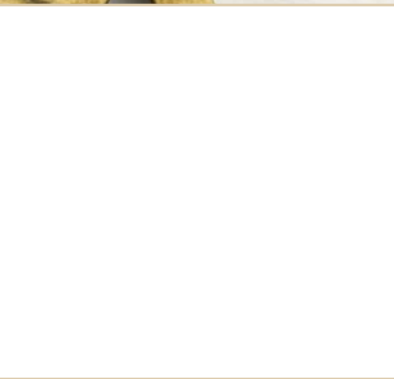

linea
Decor
SERIE 606

GIUSTI



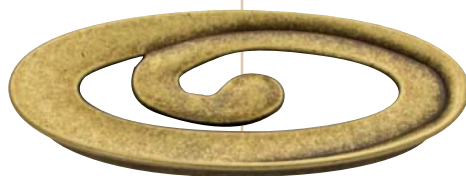



WMN606.096



			
96	120	18	48





WMN606.064



			
64	83	18	30





WP0606.032



			
32	56	18	56

> WCH7200/42
WCH7200/53



			
42	25	70	6
53	25	81	6

WBC8200



			
-	25	-	55

FINITURE / FINISHING

-  00D1 > ANTICA FIRENZE
ANTIQUE FLORENCE
-  00I1 > ANTICA ROMA
ANTIQUE ROME
-  00A8 > ORVAL
ORVAL
-  00E8 > ARGENTO VECCHIO BRILLANTE
SHINY OLD SILVER



linea
Decor

SERIE 633 SMALTO-ENAMEL



GIUSTI



SMALTO / ENAMEL

- RIV02 > CON RESINA TRASPARENTE
WITH TRANSPARENT RESIN
- NIV02 > SENZA RESINA / WITHOUT RESIN

FINITURE SMALTO / ENAMEL FINISHING

-  .NIV02 > SMALTO AVORIO
IVORY ENAMEL
-  .NSG02 > SMALTO SILVER GLITTER
SILVER GLITTER ENAMEL
-  .NBG02 > SMALTO BLACK GLITTER
BLACK GLITTER ENAMEL

WMN633.128



			
128	145	25	21

WP0633.A64







			
64	86	24	86

COMBINAZIONI SMALTO DISPONIBILI
AVAILABLE ENAMEL MATCHING

-  .NIVD1 > ANTICA FIRENZE
ANTIQUE FLORENCE
-  .NIV02 > CROMO LUCIDO
POLISHED CHROME
-  .NSG02 > CROMO LUCIDO
POLISHED CHROME
-  .NBG02 > CROMO LUCIDO
POLISHED CHROME

WMN633.096



			
96	114	25	21

WP0633.B32







			
32	50	24	50

FINITURE METALLO / METAL FINISHING

-  OOD1 > ANTICA FIRENZE
ANTIQUE FLORENCE
-  OOO2 > CROMO LUCIDO
POLISHED CHROME

WP0633.C32



			
32	48	21	21

WP0633.017



			
-	-	21	17



linea
Decor

SERIE 550 SMALTO-ENAMEL



GIUSTI



WMN550.128



128	140	25	13

WMN550.096



96	107	22	13

SMALTO / ENAMEL

RIV02 > CON RESINA TRASPARENTE

WITH TRANSPARENT RESIN

NIV02 > SENZA RESINA / WITHOUT RESIN

FINITURE SMALTO / ENAMEL FINISHING

.RIV02 > SMALTO AVORIO
IVORY ENAMEL

.RSG02 > SMALTO SILVER GLITTER
SILVER GLITTER ENAMEL

.RBG02 > SMALTO BLACK GLITTER
BLACK GLITTER ENAMEL

WP0550.032



32	49	24	49

WP0550.016



16	25	23	25

COMBINAZIONI SMALTO DISPONIBILI
AVAILABLE ENAMEL MATCHING

.RIVD1 > ANTICA FIRENZE
ANTIQUE FLORENCE

.RIV02 > CROMO LUCIDO
POLISHED CHROME

.RSG02 > CROMO LUCIDO
POLISHED CHROME

.RBG02 > CROMO LUCIDO
POLISHED CHROME

WP0550.000



-	13	21	13

FINITURE METALLO / METAL FINISHING

00D1 > ANTICA FIRENZE
ANTIQUE FLORENCE

00O2 > CROMO LUCIDO
POLISHED CHROME



linea
Decor

SERIE 659



GIUSTI

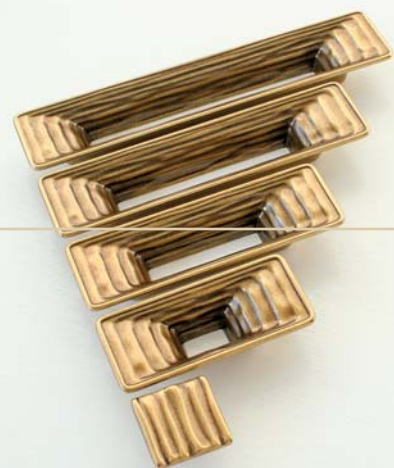
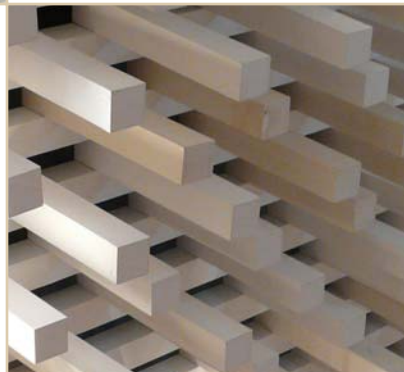

WMN659.128



128	175	20	35

WMN659.096



96	144	20	35

WMN659.064



64	112	20	35

FINITURE / FINISHING

-  00D1 > ANTICA FIRENZE
ANTIQUE FLORENCE
-  00A8 > ORVAL
ORVAL
-  00GP > PLACCATO ORO
GOLD PLATED

WMN659.032



32	80	20	35

WP0666.000



-	30	20	30

-  00M5 > ARGENTO VENEZIA
VENETIAN SILVER
-  00E8 > ARGENTO VECCHIO BRILLANTE
SHINY OLD SILVER
-  0002 > CROMO LUCIDO
POLISHED CHROME
-  00F7 > VERNICIATO NICHEL SATINATO
VARNISHED NICKEL SATINED
-  00M1 > NICHEL LUCIDO
POLISHED NICKEL



linea
Decor
SERIE 666

GIUSTI

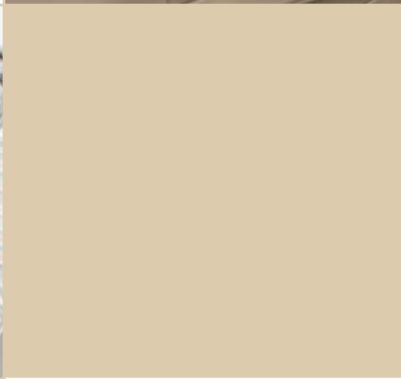
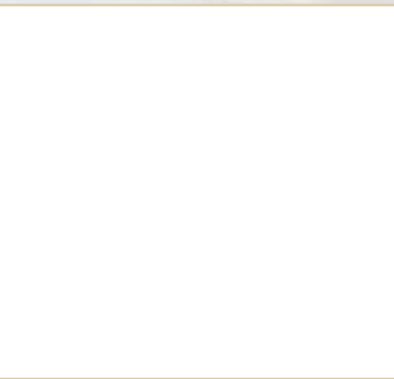





WMN666.192



			
192	216	21	21

WMN666.128







			
128	152	21	21

FINITURE / FINISHING

-  OOD1 > ANTICA FIRENZE
ANTIQUE FLORENCE
-  OOA8 > ORVAL
ORVAL
-  OOGP > PLACCATO ORO
GOLD PLATED





WMN666.096



			
96	120	21	21

WP0666.000



			
-	30	20	30

-  OOM5 > ARGENTO VENEZIA
VENETIAN SILVER
-  OOE8 > ARGENTO VECCHIO BRILLANTE
SHINY OLD SILVER
-  OOO2 > CROMO LUCIDO
POLISHED CHROME
-  OOF7 > VERNICIATO NICHEL SATINATO
VARNISHED NICKEL SATINED
-  OOM1 > NICHEL LUCIDO
POLISHED NICKEL



linea
Decor
SERIE 661

GIUSTI

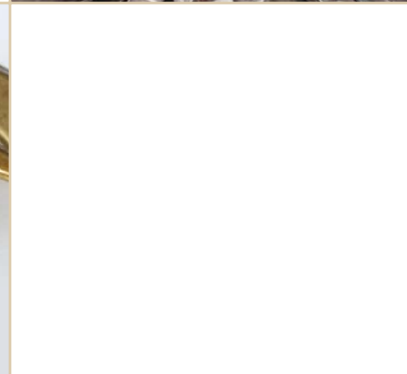
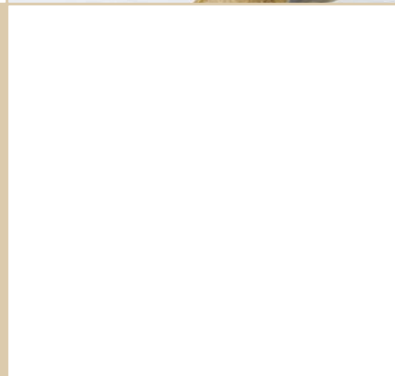
WMN661.096



96	168	28	45

WMN661.064



64	140	28	35

WPO661.000



-	11	20	35

FINITURE / FINISHING

-  00D1 > ANTICA FIRENZE
ANTIQUE FLORENCE
-  00A8 > ORVAL
ORVAL

WPO661.B32



32	100	25	42

WPO661.C16



16	62	23	26



linea
Decor
SERIE 662

GIUSTI

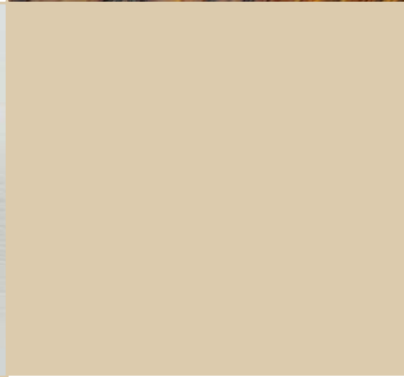
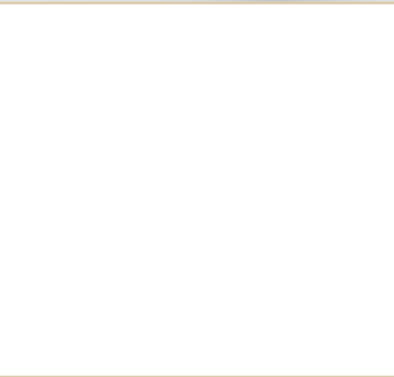

WMN662.A16



16	108	24	68

WMN662.B16

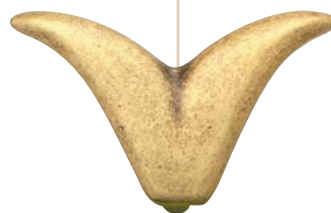

16	90	23	60

FINITURE / FINISHING

-  OOD1 > ANTICA FIRENZE
ANTIQUE FLORENCE
-  OOA8 > ORVAL
ORVAL
-  OOGP > PLACCATO ORO
GOLD PLATED

-  OOM5 > ARGENTO VENEZIA
VENETIAN SILVER
-  OOE8 > ARGENTO VECCHIO BRILLANTE
SHINY OLD SILVER
-  OOO2 > CROMO LUCIDO
POLISHED CHROME
-  OOF7 > VERNICIATO NICHEL SATINATO
VARNISHED NICKEL SATINED
-  OOM1 > NICHEL LUCIDO
POLISHED NICKEL



linea Decor

SERIE 667 SMALTO-ENAMEL



GIUSTI



SMALTO / ENAMEL

RIV02 > CON RESINA TRASPARENTE
WITH TRANSPARENT RESIN

NIV02 > SENZA RESINA / WITHOUT RESIN

FINITURE SMALTO / ENAMEL FINISHING



.NIV02 > SMALTO AVORIO
IVORY ENAMEL



.NSG02 > SMALTO SILVER GLITTER
SILVER GLITTER ENAMEL



.NBG02 > SMALTO BLACK GLITTER
BLACK GLITTER ENAMEL

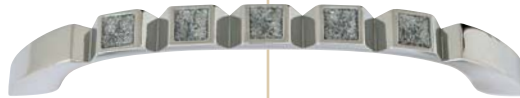

WMN667.128

⌀	↔	↑	↓
128	142	27	14

COMBINAZIONI SMALTO DISPONIBILI AVAILABLE ENAMEL MATCHING



.NIVD1 > ANTICA FIRENZE
ANTIQUE FLORENCE



.NBGGP > PLACCATO ORO
GOLD PLATED



.NSG02 > CROMO LUCIDO
POLISHED CHROME



.NBG02 > CROMO LUCIDO
POLISHED CHROME

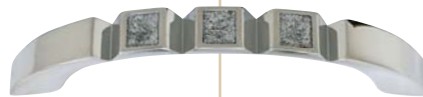

WMN667.096

⌀	↔	↑	↓
96	112	26	14

FINITURE METALLO / METAL FINISHING



OOD1 > ANTICA FIRENZE
ANTIQUE FLORENCE



OOO2 > CROMO LUCIDO
POLISHED CHROME



OOGP > PLACCATO ORO
GOLD PLATED



OOE2 > CANNA DI FUCILE
BLACK NICKEL

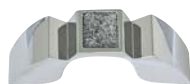

WMN667.032

⌀	↔	↑	↓
32	48	20	14

WPN667.016



⌀	↔	↑	↓
16	14	20	58

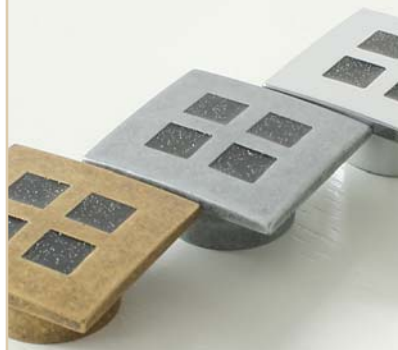

linea
Decor

SERIE 655 SMALTO-ENAMEL



GIUSTI



WP0655.016



16	54	20	54

SMALTO / ENAMEL

RIV02 > CON RESINA TRASPARENTE

WITH TRANSPARENT RESIN

NIV02 > SENZA RESINA / WITHOUT RESIN

FINITURE SMALTO / ENAMEL FINISHING

.NIV02 > SMALTO AVORIO
IVORY ENAMEL

.NSG02 > SMALTO SILVER GLITTER
SILVER GLITTER ENAMEL

.NBG02 > SMALTO BLACK GLITTER
BLACK GLITTER ENAMEL

WP0655.000



-	36	16	36

COMBINAZIONI SMALTO DISPONIBILI
AVAILABLE ENAMEL MATCHING

.NIVD1 > ANTICA FIRENZE
ANTIQUE FLORENCE

.NBGD1 > ANTICA FIRENZE
ANTIQUE FLORENCE

.NSG02 > CROMO LUCIDO
POLISHED CHROME

.NBG02 > CROMO LUCIDO
POLISHED CHROME

FINITURE METALLO / METAL FINISHING

OOD1 > ANTICA FIRENZE
ANTIQUE FLORENCE

O002 > CROMO LUCIDO
POLISHED CHROME

O020 > FORGIA ANTICA
ANTIQUE FORGE



linea
Decor

SERIE 600



GIUSTI



WMN600.110



110	140	20	99

WMN600.A90



90	114	20	38

WMN600.B90

90	110	20	56

FINITURE / FINISHING

- OOD1 > ANTICA FIRENZE
ANTIQUE FLORENCE
- OOA8 > ORVAL
ORVAL
- OOE8 > ARGENTO VECCHIO BRILLANTE
SHINY OLD SILVER
- OOF7 > VERNICIATO NICHEL SATINATO
VARNISHED NICKEL SATINED



linea
Decor

SERIE 670



GIUSTI



WMN670.128



128	165	28	40

WMN670.096



96	135	27	32

FINITURE / FINISHING

- OOD1 > ANTICA FIRENZE
ANTIQUE FLORENCE
- OOA8 > ORVAL
ORVAL
- OOGP > PLACCATO ORO
GOLD PLATED

WMN670.075



75	114	(12)	32

WP0634.031



-	36	22	32

- OOM5 > ARGENTO VENEZIA
VENETIAN SILVER
- OOE8 > ARGENTO VECCHIO BRILLANTE
SHINY OLD SILVER
- OOO2 > CROMO LUCIDO
POLISHED CHROME
- OOF7 > VERNICIATO NICHEL SATINATO
VARNISHED NICKEL SATINED
- OOM1 > NICHEL LUCIDO
POLISHED NICKEL

linea Decor

SERIE 669



GIUSTI



WMN669.128



128	140	23	17

WMN669.096



96	108	23	16

FINITURE / FINISHING

00D1 > ANTICA FIRENZE
ANTIQUE FLORENCE

00A8 > ORVAL
ORVAL

00M5 > ARGENTO VENEZIA
VENETIAN SILVER

00E8 > ARGENTO VECCHIO BRILLANTE
SHINY OLD SILVER

00F7 > VERNICIATO NICHEL SATINATO
VARNISHED NICKEL SATINED

WP0669.000



-	30	22	30

WBC603.000



-	25	-	49

> WCH603/42
WCH603/53



42	35	67	6
53	35	78	6

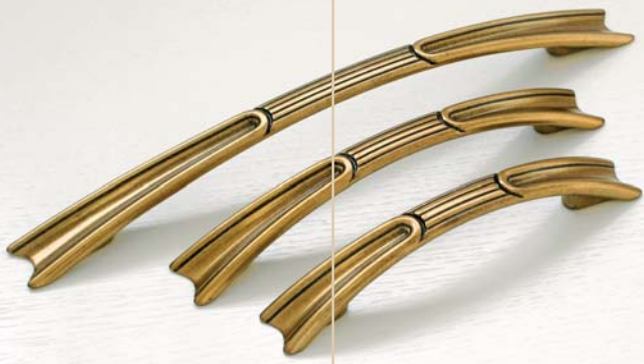

linea
Decor

SERIE 675



GIUSTI



WMN675.192



192	250	28	23

WMN675.128



128	166	28	23

WMN675.096



96	140	26	21

FINITURE / FINISHING

OOD1 > ANTICA FIRENZE
ANTIQUE FLORENCE

OOA8 > ORVAL
ORVAL

OOM5 > ARGENTO VENEZIA
VENETIAN SILVER

OOE8 > ARGENTO VECCHIO BRILLANTE
SHINY OLD SILVER

OOF7 > VERNICIATO NICHEL SATINATO
VARNISHED NICKEL SATINED

WPO2025/35
WPO2025/30
WPO2025/25



-	35	28	35
-	30	25	30
-	25	22	25

WBC603.000



-	25	-	49

> WCH7201/42
WCH7201/53



-	42	35	72
-	53	35	83



linea
Decor

SERIE 684



GIUSTI



WMN684.128



⌀	↔	↑	↓
128	142	23	24

WMN684.096



⌀	↔	↑	↓
96	108	23	20

WPO684.033



⌀	↔	↑	↓
-	35	23	32

FINITURE / FINISHING

- 00D1 > ANTICA FIRENZE
ANTIQUE FLORENCE
- 00A8 > ORVAL
ORVAL
- 00GP > PLACCATO ORO
GOLD PLATED

- 00M5 > ARGENTO VENEZIA
VENETIAN SILVER
- 00E8 > ARGENTO VECCHIO BRILLANTE
SHINY OLD SILVER
- 0002 > CROMO LUCIDO
POLISHED CHROME
- 00F7 > VERNICIATO NICHEL SATINATO
VARNISHED NICKEL SATINED
- 00M1 > NICHEL LUCIDO
POLISHED NICKEL

WBC8201



⌀	↔	↑	↓
-	24	-	37

> WCH7201/42
WCH7201/53



└	↔	↑	⌀
42	35	72	6
53	35	83	6



linea
Decor

SERIE 673



GIUSTI



WMN673.096



96	140	24	45

WMN673.064



64	106	21	35

FINITURE / FINISHING

- OOD1 > ANTICA FIRENZE
ANTIQUE FLORENCE
- OOA8 > ORVAL
ORVAL
- OOGP > PLACCATO ORO
GOLD PLATED

WP0673.030



-	30	20	30

WBC8037/SP



-	20	-	44

> WCH7024/42
WCH7024/53



42	36	74	6
53	36	85	6

- OOM5 > ARGENTO VENEZIA
VENETIAN SILVER
- OOE8 > ARGENTO VECCHIO BRILLANTE
SHINY OLD SILVER
- OOO2 > CROMO LUCIDO
POLISHED CHROME
- OOF7 > VERNICIATO NICHEL SATINATO
VARNISHED NICKEL SATINED
- OOM1 > NICHEL LUCIDO
POLISHED NICKEL



linea
Decor

SERIE 688



GIUSTI



WMN688.224



⊕	↔	↑	↓
224	256	25	30

WMN688.128

WMN688.096



⊕	↔	↑	↓
128	160	25	30

⊕	↔	↑	↓
96	118	23	26

FINITURE / FINISHING

-  OOD1 > ANTICA FIRENZE
ANTIQUE FLORENCE
-  OOA8 > ORVAL
ORVAL
-  OOGP > PLACCATO ORO
GOLD PLATED
-  OON3 > LACCATO BIANCO MATT
WHITE MATT

WP0688.032

WP0688.000



⊕	↔	↑	↓
32	55	23	55

⊕	↔	↑	↓
-	34	23	34







linea
Decor
SERIE 674

GIUSTI







WMN674.096



			
96	128	22	45

WMN674.064



			
64	100	21	38

WPO674.000



			
-	34	21	34

FINITURE / FINISHING

-  00D1 > ANTICA FIRENZE
ANTIQUE FLORENCE
-  00A8 > ORVAL
ORVAL
-  00GP > PLACCATO ORO
GOLD PLATED

-  00M5 > ARGENTO VENEZIA
VENETIAN SILVER
-  00E8 > ARGENTO VECCHIO BRILLANTE
SHINY OLD SILVER
-  00O2 > CROMO LUCIDO
POLISHED CHROME
-  00F7 > VERNICIATO NICHEL SATINATO
VARNISHED NICKEL SATINED
-  00M1 > NICHEL LUCIDO
POLISHED NICKEL







linea
Decor
SERIE 696

GIUSTI







WMN696.128



			
128	150	26	31

WMN696.096



			
96	115	26	25

WP0696.000



			
-	35	23	32

FINITURE / FINISHING

-  00D1 > ANTICA FIRENZE
ANTIQUE FLORENCE
-  00A8 > ORVAL
ORVAL
-  00GP > PLACCATO ORO
GOLD PLATED

-  00M5 > ARGENTO VENEZIA
VENETIAN SILVER
-  00E8 > ARGENTO VECCHIO BRILLANTE
SHINY OLD SILVER
-  0002 > CROMO LUCIDO
POLISHED CHROME
-  00F7 > VERNICIATO NICHEL SATINATO
VARNISHED NICKEL SATINED
-  00M1 > NICHEL LUCIDO
POLISHED NICKEL



WBC627.000



			
-	26	-	84

> WCH7097/42
WCH7097/53



			
42	25	78	6
53	25	89	6



linea
Decor

SERIE 676



GIUSTI

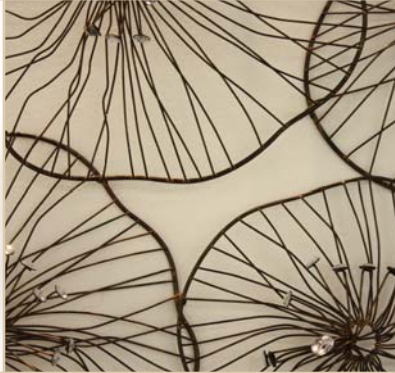

WMN676.320



⊕ ⊕	↔	⊕	⊕
320	348	33	38

WMN676.128

WMN676.096



⊕ ⊕	↔	⊕	⊕
128	160	24	40



⊕ ⊕	↔	⊕	⊕
96	137	23	39

FINITURE / FINISHING

-  OOD1 > ANTICA FIRENZE
ANTIQUE FLORENCE
-  OOA8 > ORVAL
ORVAL
-  OOGP > PLACCATO ORO
GOLD PLATED

WMN676.064

WP0676.060

WP0676.040



⊕ ⊕	↔	⊕	⊕
64	95	23	38



⊕ ⊕	↔	⊕	⊕
-	65	23	65



⊕ ⊕	↔	⊕	⊕
-	42	22	42

-  OOM5 > ARGENTO VENEZIA
VENETIAN SILVER
-  OOE8 > ARGENTO VECCHIO BRILLANTE
SHINY OLD SILVER
-  OOO2 > CROMO LUCIDO
POLISHED CHROME
-  OOF7 > VERNICIATO NICHEL SATINATO
VARNISHED NICKEL SATINED
-  OOM1 > NICHEL LUCIDO
POLISHED NICKEL



linea
Decor

SERIE 683



GIUSTI



WMN683.128



128	166	30	24

WMN683.096



96	135	30	21

WP0683.028



-	28	28	28

FINITURE / FINISHING

- 00D1 > ANTICA FIRENZE
ANTIQUE FLORENCE
- 00A8 > ORVAL
ORVAL
- 00GP > PLACCATO ORO
GOLD PLATED

- 00M5 > ARGENTO VENEZIA
VENETIAN SILVER
- 00E8 > ARGENTO VECCHIO BRILLANTE
SHINY OLD SILVER
- 0002 > CROMO LUCIDO
POLISHED CHROME
- 00F7 > VERNICIATO NICHEL SATINATO
VARNISHED NICKEL SATINED
- 00M1 > NICHEL LUCIDO
POLISHED NICKEL



linea
Decor

SERIE 685



GIUSTI

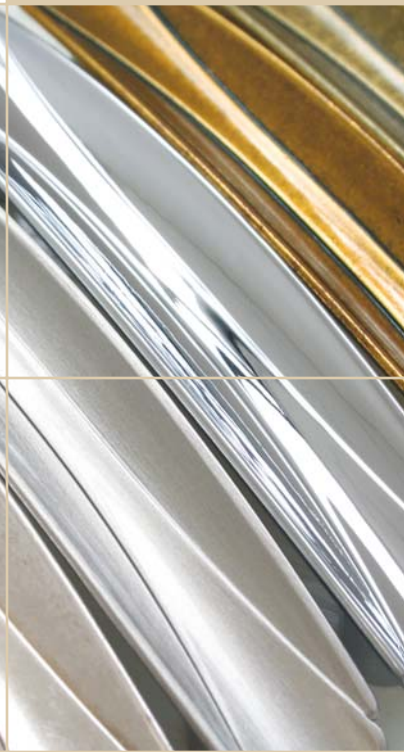

WMN685.128



128	165	25	24

WMN685.096



96	132	25	24

WP0685.000



-	34	25	30

FINITURE / FINISHING

- 00D1 > ANTICA FIRENZE
ANTIQUE FLORENCE
- 00A8 > ORVAL
ORVAL
- 00GP > PLACCATO ORO
GOLD PLATED

- 00M5 > ARGENTO VENEZIA
VENETIAN SILVER
- 00E8 > ARGENTO VECCHIO BRILLANTE
SHINY OLD SILVER
- 00O2 > CROMO LUCIDO
POLISHED CHROME
- 00F7 > VERNICIATO NICHEL SATINATO
VARNISHED NICKEL SATINED
- 00M1 > NICHEL LUCIDO
POLISHED NICKEL



linea
Decor

SERIE 697



GIUSTI



WMN697.224



⊕	↔	↑	↓
224	290	24	40

WMN697.128



⊕	↔	↑	↓
128	154	24	40

WMN697.096



⊕	↔	↑	↓
96	120	24	38

FINITURE / FINISHING

-  OOD1 > ANTICA FIRENZE
ANTIQUE FLORENCE
-  OOA8 > ORVAL
ORVAL
-  OOGP > PLACCATO ORO
GOLD PLATED

WMN697.064



⊕	↔	↑	↓
64	94	22	34

WP0697.000



⊕	↔	↑	↓
-	36	22	35

-  OOM5 > ARGENTO VENEZIA
VENETIAN SILVER
-  OOE8 > ARGENTO VECCHIO BRILLANTE
SHINY OLD SILVER
-  OOO2 > CROMO LUCIDO
POLISHED CHROME
-  OOF7 > VERNICIATO NICHEL SATINATO
VARNISHED NICKEL SATINED
-  OOM1 > NICHEL LUCIDO
POLISHED NICKEL



linea
Decor

SERIE 682



GIUSTI



WMN682.A64



64	110	21	50

WMN682.B64



64	95	21	44

WMN682.032



32	77	21	38

FINITURE / FINISHING

- OOD1 > ANTICA FIRENZA
ANTIQUE FLORENCE
- OOA8 > ORVAL
ORVAL
- OOGP > PLACCATO ORO
GOLD PLATED

WBC8201



-	24	-	37

> WCH7201/42
WCH7201/53



42	35	72	6
53	35	83	6

- OOM5 > ARGENTO VENEZIA
VENETIAN SILVER
- OOE8 > ARGENTO VECCHIO BRILLANTE
SHINY OLD SILVER
- OOO2 > CROMO LUCIDO
POLISHED CHROME
- OOF7 > VERNICIATO NICHEL SATINATO
VARNISHED NICKEL SATINED
- OOM1 > NICHEL LUCIDO
POLISHED NICKEL



linea
Decor

SERIE 695



GIUSTI



WMN695.128



128	142	26	25

WMN695.096



96	109	25	22

WP0695.000



-	31	22	31

FINITURE / FINISHING

- 00D1 > ANTICA FIRENZE
ANTIQUE FLORENCE
- 00A8 > ORVAL
ORVAL
- 00GP > PLACCATO ORO
GOLD PLATED

- 00M5 > ARGENTO VENEZIA
VENETIAN SILVER
- 00E8 > ARGENTO VECCHIO BRILLANTE
SHINY OLD SILVER
- 0002 > CROMO LUCIDO
POLISHED CHROME
- 00F7 > VERNICIATO NICHEL SATINATO
VARNISHED NICKEL SATINED
- 00M1 > NICHEL LUCIDO
POLISHED NICKEL



linea
Decor

SERIE 671



GIUSTI



WMN671.128



128	150	25	39

WMN671.096



96	114	23	30

FINITURE / FINISHING

- OOD1 > ANTICA FIRENZE
ANTIQUE FLORENCE
- OOA8 > ORVAL
ORVAL
- OOGP > PLACCATO ORO
GOLD PLATED

WMN670.075



75	114	(12)	32

WPO634.031



-	36	22	32

- OOM5 > ARGENTO VENEZIA
VENETIAN SILVER
- OOE8 > ARGENTO VECCHIO BRILLANTE
SHINY OLD SILVER
- OOO2 > CROMO LUCIDO
POLISHED CHROME
- OOF7 > VERNICIATO NICHEL SATINATO
VARNISHED NICKEL SATINED
- OOM1 > NICHEL LUCIDO
POLISHED NICKEL



linea
Decor

SERIE 668



GIUSTI



WMN668.128



128	172	27	17

WMN668.096



96	140	27	17

WP0668.000



-	30	23	30

FINITURE / FINISHING

00D1 > ANTICA FIRENZE
ANTIQUE FLORENCE

00A8 > ORVAL
ORVAL

00M5 > ARGENTO VENEZIA
VENETIAN SILVER

00E8 > ARGENTO VECCHIO BRILLANTE
SHINY OLD SILVER

00F7 > VERNICIATO NICHEL SATINATO
VARNISHED NICKEL SATINATED



linea
Decor

SERIE 704



GIUSTI



(*) FISSAGGIO VITE M6/
SCREW FOR FIXING M6

WFR704.078



-	52	78	52

FINITURE / FINISHING

- 00D1 > ANTICA FIRENZE
ANTIQUE FLORENCE
- 00A8 > ORVAL
ORVAL
- 00GP > PLACCATO ORO
GOLD PLATED

- 00M5 > ARGENTO VENEZIA
VENETIAN SILVER
- 00E8 > ARGENTO VECCHIO BRILLANTE
SHINY OLD SILVER
- 0002 > CROMO LUCIDO
POLISHED CHROME
- 0003 > NICHEL SATINATO
NICKEL SATINED
- 00M1 > NICHEL LUCIDO
POLISHED NICKEL

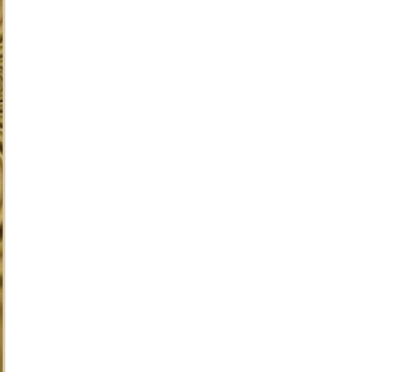

linea
Decor
SERIE 700

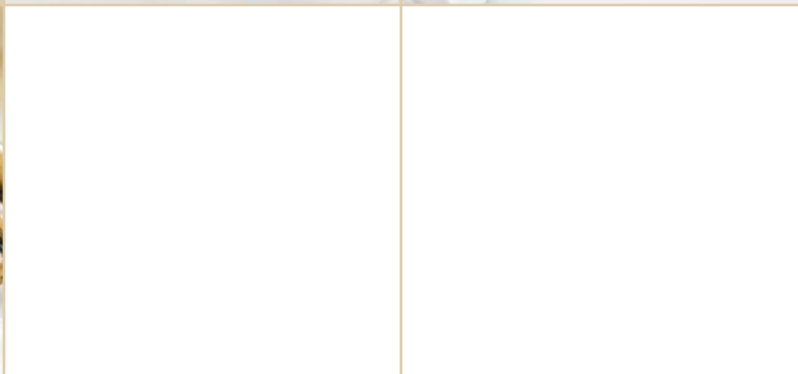

GIUSTI

- FINITURE / FINISHING**
-  00M2 > LACCATO AVORIO LUCIDO
SHINY IVORY
 -  00N9 > LACCATO MADREPERLA
MOTHER OF PEARL
 -  00M5 > ARGENTO VENEZIA
VENETIAN SILVER
 -  00SP > PLACCATO ARGENTO
SILVER PLATED
 -  0002 > CROMO LUCIDO
POLISHED CHROME



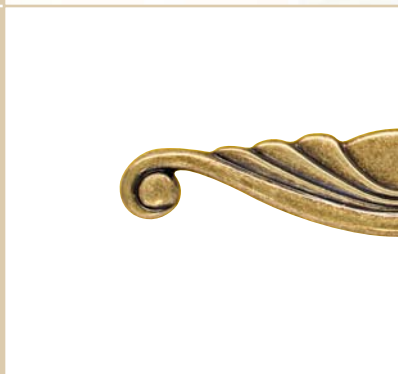

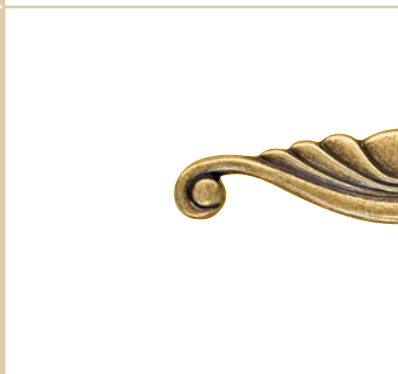

WMN700.160

			
160	179	27	34

-  00T4 > BIANCO VINTAGE ARGENTO
WHITE VINTAGE SILVER
-  00R3 > ARGENTO NOTTINGHAM
NOTTINGHAM SILVER
-  00F7 > VERNICIATO NICHEL SATINATO
VARNISHED NICKEL SATINED
-  00M1 > NICHEL LUCIDO
POLISHED NICKEL
-  00E8 > ARGENTO VECCHIO BRILLANTE
SHINY OLD SILVER
-  00T5 > AVORIO VINTAGE ORO
IVORY VINTAGE GOLD



WMN700.128

			
128	145	26	31





-  00GP > PLACCATO ORO
GOLD PLATED
-  00R4 > ORO ROMA
ROMA GOLD
-  00R8 > ORO MILANO
MILANO GOLD
-  00A8 > ORVAL
ORVAL
-  00D1 > ANTICA FIRENZE
ANTIQUÉ FLORENCE



WMN700.096

WPO2025/35
WPO2025/30
WPO2025/25



			
-	35	28	35
-	30	25	30
-	25	22	25



linea
Decor

SERIE 701



GIUSTI



WMN701.128



⌀	↔	↑	↓
128	163	26	35

FINITURE / FINISHING

-  00M2 > LACCATO AVORIO LUCIDO
SHINY IVORY
-  00N9 > LACCATO MADREPERLA
MOTHER OF PEARL
-  00M5 > ARGENTO VENEZIA
VENETIAN SILVER
-  00SP > PLACCATO ARGENTO
SILVER PLATED
-  0002 > CROMO LUCIDO
POLISHED CHROME

WMN701.096



⌀	↔	↑	↓
96	112	25	30

-  00T4 > BIANCO VINTAGE ARGENTO
WHITE VINTAGE SILVER
-  00R3 > ARGENTO NOTTINGHAM
NOTTINGHAM SILVER
-  00F7 > VERNICIATO NICHEL SATINATO
VARNISHED NICKEL SATINED
-  00M1 > NICHEL LUCIDO
POLISHED NICKEL
-  00E8 > ARGENTO VECCHIO BRILLANTE
SHINY OLD SILVER
-  00T5 > AVORIO VINTAGE ORO
IVORY VINTAGE GOLD

-  00GP > PLACCATO ORO
GOLD PLATED
-  00R4 > ORO ROMA
ROMA GOLD
-  00R8 > ORO MILANO
MILANO GOLD
-  00A8 > ORVAL
ORVAL
-  00D1 > ANTICA FIRENZE
ANTIQUE FLORENCE



linea
Decor

SERIE 702



GIUSTI

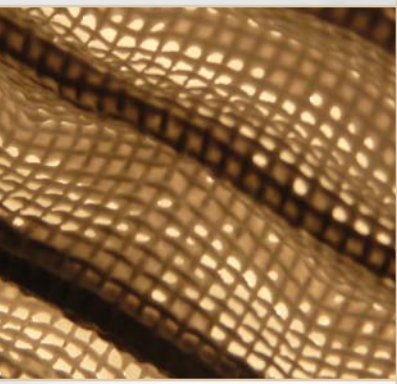

WMN702.128

FINITURE / FINISHING

-  00M2 > LACCATO AVORIO LUCIDO
SHINY IVORY
-  00N9 > LACCATO MADREPERLA
MOTHER OF PEARL
-  00M5 > ARGENTO VENEZIA
VENETIAN SILVER
-  00SP > PLACCATO ARGENTO
SILVER PLATED
-  0002 > CROMO LUCIDO
POLISHED CHROME







			
128	145	24	36

WMN702.096

-  00T4 > BIANCO VINTAGE ARGENTO
WHITE VINTAGE SILVER
-  00R3 > ARGENTO NOTTINGHAM
NOTTINGHAM SILVER
-  00F7 > VERNICIATO NICHEL SATINATO
VARNISHED NICKEL SATINED
-  00M1 > NICHEL LUCIDO
POLISHED NICKEL
-  00E8 > ARGENTO VECCHIO BRILLANTE
SHINY OLD SILVER
-  00T5 > AVORIO VINTAGE ORO
IVORY VINTAGE GOLD







			
96	114	24	28

WP0702.030

-  00GP > PLACCATO ORO
GOLD PLATED
-  00R4 > ORO ROMA
ROMA GOLD
-  00R8 > ORO MILANO
MILANO GOLD
-  00A8 > ORVAL
ORVAL
-  00D1 > ANTICA FIRENZE
ANTIQUE FLORENCE



			
-	30	20	30

linea Decor

SERIE 703



GIUSTI



WMN703.160



160	185	27	26

WMN703.128



128	153	27	26

WP0703.040



-	40	25	40

WP0703.034



-	34	23	34

METACRILATO / METACRYLATE

MTD0 > METACRILATO TRASPARENTE
METACRYLATE TRANSPARENT

FINITURE / FINISHING

MTD1 > ANTICA FIRENZE
ANTIQUE FLORENCE

MTA8 > ORVAL
ORVAL

MTGP > PLACCATO ORO
GOLD PLATED

MTM5 > ARGENTO VENEZIA
VENETIAN SILVER

MTE8 > ARGENTO VECCHIO BRILLANTE
SHINY OLD SILVER

MT02 > CROMO LUCIDO
POLISHED CHROME

MTF7 > VERNICIATO NICHEL SATINATO
VARNISHED NICKEL SATINED

MTM1 > NICHEL LUCIDO
POLISHED NICKEL



linea Decor

SERIE 705



GIUSTI

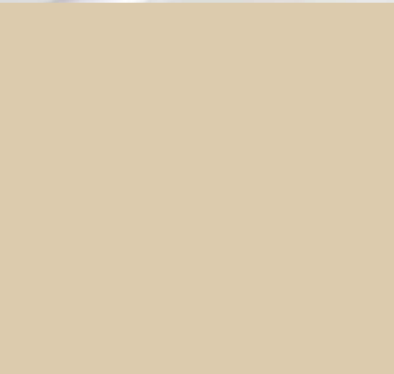

FINITURE / FINISHING

-  00M2 > LACCATO AVORIO LUCIDO
SHINY IVORY
-  00N9 > LACCATO MADREPERLA
MOTHER OF PEARL
-  00M5 > ARGENTO VENEZIA
VENETIAN SILVER
-  00SP > PLACCATO ARGENTO
SILVER PLATED
-  0002 > CROMO LUCIDO
POLISHED CHROME

WMN705.128



			
128	154	25	30

-  00T4 > BIANCO VINTAGE ARGENTO
WHITE VINTAGE SILVER
-  00R3 > ARGENTO NOTTINGHAM
NOTTINGHAM SILVER
-  00F7 > VERNICIATO NICHEL SATINATO
VARNISHED NICKEL SATINED
-  00M1 > NICHEL LUCIDO
POLISHED NICKEL
-  00E8 > ARGENTO VECCHIO BRILLANTE
SHINY OLD SILVER
-  00T5 > AVORIO VINTAGE ORO
IVORY VINTAGE GOLD

WMN705.096







			
96	119	24	25

-  00GP > PLACCATO ORO
GOLD PLATED
-  00R4 > ORO ROMA
ROMA GOLD
-  00R8 > ORO MILANO
MILANO GOLD
-  00A8 > ORVAL
ORVAL
-  00D1 > ANTICA FIRENZE
ANTIQUE FLORENCE

WP0702.030



			
-	30	20	30



linea
Decor

SERIE 706



GIUSTI



WMN706.224

WMN706.160



160	185	30	23

FINITURE / FINISHING

00M2 > LACCATO AVORIO LUCIDO
SHINY IVORY

WMN706.128



128	152	28	22

- 00M5 > ARGENTO VENEZIA
VENETIAN SILVER
- 00O2 > CROMO LUCIDO
POLISHED CHROME
- 00T4 > BIANCO VINTAGE ARGENTO
WHITE VINTAGE SILVER
- 00R3 > ARGENTO NOTTINGHAM
NOTTINGHAM SILVER
- 00F7 > VERNICIATO NICHEL SATINATO
VARNISHED NICKEL SATINED
- 00E8 > ARGENTO VECCHIO BRILLANTE
SHINY OLD SILVER

WMN706.096

WP0706.035



224	271	32	35

96	120	26	22

-	35	25	35

- 00T5 > AVORIO VINTAGE ORO
IVORY VINTAGE GOLD
- 00R4 > ORO ROMA
ROMA GOLD
- 00R8 > ORO MILANO
MILANO GOLD
- 00A8 > ORVAL
ORVAL
- 00D1 > ANTICA FIRENZE
ANTIQUE FLORENCE



linea Decor

SERIE 707



GIUSTI



FINITURE / FINISHING

-  00M2 > LACCATO AVORIO LUCIDO
SHINY IVORY
-  00N9 > LACCATO MADREPERLA
MOTHER OF PEARL
-  00M5 > ARGENTO VENEZIA
VENETIAN SILVER
-  00SP > PLACCATO ARGENTO
SILVER PLATED
-  0002 > CROMO LUCIDO
POLISHED CHROME

-  00T4 > BIANCO VINTAGE ARGENTO
WHITE VINTAGE SILVER
-  00R3 > ARGENTO NOTTINGHAM
NOTTINGHAM SILVER
-  00F7 > VERNICIATO NICHEL SATINATO
VARNISHED NICKEL SATINED
-  00M1 > NICHEL LUCIDO
POLISHED NICKEL
-  00E8 > ARGENTO VECCHIO BRILLANTE
SHINY OLD SILVER
-  00T5 > AVORIO VINTAGE ORO
IVORY VINTAGE GOLD

-  00GP > PLACCATO ORO
GOLD PLATED
-  00R4 > ORO ROMA
ROMA GOLD
-  00R8 > ORO MILANO
MILANO GOLD
-  00A8 > ORVAL
ORVAL
-  00D1 > ANTICA FIRENZE
ANTIQUÉ FLORENCE

WMN707.192



192	238	30	46

WMN707.128

WP0707.000



128	174	28	46

-	38	24	38

WMN707.096

WP0707.032



96	145	26	33

32	55	24	55



linea
Decor

SERIE 711



GIUSTI



WMN711.224



⊕	↔	↑	↓
224	258	26	49

WMN711.096



⊕	↔	↑	↓
96	159	25	46

WMN711.064



⊕	↔	↑	↓
64	110	23	34

WP0711.000



⊕	↔	↑	∅
-	36	24	36

FINITURE / FINISHING

- 00M2 > LACCATO AVORIO LUCIDO
SHINY IVORY
- 00N9 > LACCATO MADREPERLA
MOTHER OF PEARL
- 00M5 > ARGENTO VENEZIA
VENETIAN SILVER
- 00SP > PLACCATO ARGENTO
SILVER PLATED
- 0002 > CROMO LUCIDO
POLISHED CHROME

- 00T4 > BIANCO VINTAGE ARGENTO
WHITE VINTAGE SILVER
- 00R3 > ARGENTO NOTTINGHAM
NOTTINGHAM SILVER
- 00F7 > VERNICIATO NICHEL SATINATO
VARNISHED NICKEL SATINED
- 00M1 > NICHEL LUCIDO
POLISHED NICKEL
- 00E8 > ARGENTO VECCHIO BRILLANTE
SHINY OLD SILVER
- 00T5 > AVORIO VINTAGE ORO
IVORY VINTAGE GOLD

- 00GP > PLACCATO ORO
GOLD PLATED
- 00R4 > ORO ROMA
ROMA GOLD
- 00R8 > ORO MILANO
MILANO GOLD
- 00A8 > ORVAL
ORVAL
- 00D1 > ANTICA FIRENZE
ANTIQUE FLORENCE



linea Decor

SERIE 712



GIUSTI



WMN712.160

FINITURE / FINISHING

-  00M2 > LACCATO AVORIO LUCIDO
SHINY IVORY
-  00N9 > LACCATO MADREPERLA
MOTHER OF PEARL
-  00M5 > ARGENTO VENEZIA
VENETIAN SILVER
-  00SP > PLACCATO ARGENTO
SILVER PLATED
-  0002 > CROMO LUCIDO
POLISHED CHROME



160	202	25	29

WMN712.128

-  00T4 > BIANCO VINTAGE ARGENTO
WHITE VINTAGE SILVER
-  00R3 > ARGENTO NOTTINGHAM
NOTTINGHAM SILVER
-  00F7 > VERNICIATO NICHEL SATINATO
VARNISHED NICKEL SATINED
-  00M1 > NICHEL LUCIDO
POLISHED NICKEL
-  00E8 > ARGENTO VECCHIO BRILLANTE
SHINY OLD SILVER
-  00T5 > AVORIO VINTAGE ORO
IVORY VINTAGE GOLD



128	162	24	26

WMN712.096

-  00GP > PLACCATO ORO
GOLD PLATED
-  00R4 > ORO ROMA
ROMA GOLD
-  00R8 > ORO MILANO
MILANO GOLD
-  00A8 > ORVAL
ORVAL
-  00D1 > ANTICA FIRENZE
ANTIQUÉ FLORENCE



96	128	23	24

WP0712.000



-	36	24	36



linea
Decor

SERIE 580



GIUSTI



WMN580.224



224	275	48	30

FINITURE / FINISHING

- 00M2 > LACCATO AVORIO LUCIDO
SHINY IVORY
- 00N9 > LACCATO MADREPERLA
MOTHER OF PEARL
- 00M5 > ARGENTO VENEZIA
VENETIAN SILVER
- 00SP > PLACCATO ARGENTO
SILVER PLATED
- 0002 > CROMO LUCIDO
POLISHED CHROME

- 00T4 > BIANCO VINTAGE ARGENTO
WHITE VINTAGE SILVER
- 00R3 > ARGENTO NOTTINGHAM
NOTTINGHAM SILVER
- 00F7 > VERNICIATO NICHEL SATINATO
VARNISHED NICKEL SATINED
- 00M1 > NICHEL LUCIDO
POLISHED NICKEL
- 00E8 > ARGENTO VECCHIO BRILLANTE
SHINY OLD SILVER
- 00T5 > AVORIO VINTAGE ORO
IVORY VINTAGE GOLD

- 00GP > PLACCATO ORO
GOLD PLATED
- 00R4 > ORO ROMA
ROMA GOLD
- 00R8 > ORO MILANO
MILANO GOLD
- 00A8 > ORVAL
ORVAL
- 00D1 > ANTICA FIRENZE
ANTIQUE FLORENCE



linea
Decor

SERIE 689



GIUSTI



WMN689.448



448	526	40	14

WMN689.160



160	238	40	14

WP0689.00T



-	78	40	14

FINITURE / FINISHING

- 00M2 > LACCATO AVORIO LUCIDO
SHINY IVORY
- 00N9 > LACCATO MADREPERLA
MOTHER OF PEARL

- 00R3 > ARGENTO NOTTINGHAM
NOTTINGHAM SILVER
- 00R4 > ORO ROMA
ROMA GOLD
- 00R8 > ORO MILANO
MILANO GOLD
- 00D1 > ANTICA FIRENZE
ANTIQUÉ FLORENCE
- 00A8 > ORVAL
ORVAL



linea
Decor

SERIE 692



GIUSTI



	⊕	↔	↑	⊘
WMN692.128	128	156	42	14
WMN692.160	160	188	42	14
WMN692.192	192	220	42	14
WMN692.224	224	252	42	14
WMN692.270	270	298	42	14
WMN692.320	320	348	42	14
WMN692.420	420	448	42	14
WMN692.448	448	476	42	14

(*) INTERASSE MODULARE /
MODULAR CENTER-DISTANCES



∅ 14

FINITURE / FINISHING

- OOM2 > LACCATO AVORIO LUCIDO
SHINY IVORY
- OON9 > LACCATO MADREPERLA
MOTHER OF PEARL
- OOR3 > ARGENTO NOTTINGHAM
NOTTINGHAM SILVER
- OOR4 > ORO ROMA
ROMA GOLD
- OOR8 > ORO MILANO
MILANO GOLD
- OOD1 > ANTICA FIRENZE
ANTIQUE FLORENCE
- OOA8 > ORVAL
ORVAL

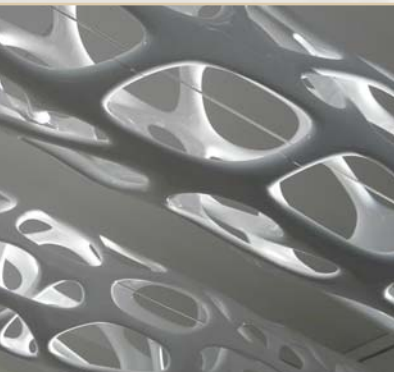
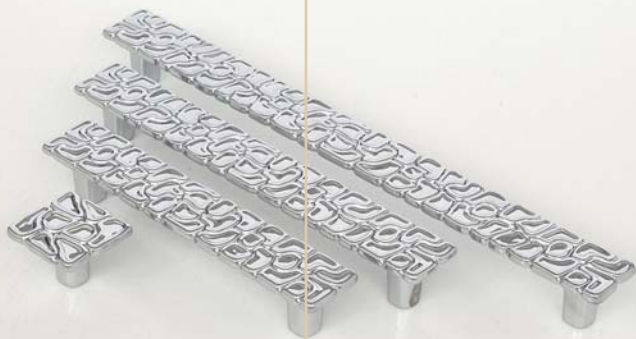

linea Decor

SERIE 718



GIUSTI

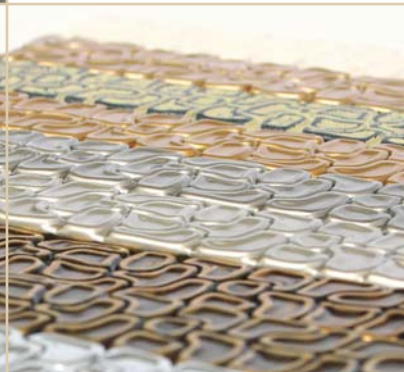

WMN718.192



192	216	22	22

FINITURE / FINISHING

- 00M2 > LACCATO AVORIO LUCIDO
SHINY IVORY
- 00M5 > ARGENTO VENEZIA
VENETIAN SILVER
- 0002 > CROMO LUCIDO
POLISHED CHROME

WMN718.128



128	152	22	22

- 00T4 > BIANCO VINTAGE ARGENTO
WHITE VINTAGE SILVER
- 00R3 > ARGENTO NOTTINGHAM
NOTTINGHAM SILVER
- 00F7 > VERNICIATO NICHEL SATINATO
VARNISHED NICKEL SATINED
- 00E8 > ARGENTO VECCHIO BRILLANTE
SHINY OLD SILVER
- 00T5 > AVORIO VINTAGE ORO
IVORY VINTAGE GOLD
- 00GP > PLACCATO ORO
GOLD PLATED

WMN718.096

WP0718.000



96	120	22	22

-	29	21	29

- 00R4 > ORO ROMA
ROMA GOLD
- 00R8 > ORO MILANO
MILANO GOLD
- 00A8 > ORVAL
ORVAL
- 00D1 > ANTICA FIRENZE
ANTIQUE FLORENCE
- 00C2 > RUSTIKALL AVORIO
RUSTIKALL IVORY



linea
Decor

SERIE 719



GIUSTI



WMN719.128



128	156	25	40

FINITURE / FINISHING

- OOM2 > LACCATO AVORIO LUCIDO
SHINY IVORY
- OOM5 > ARGENTO VENEZIA
VENETIAN SILVER
- O002 > CROMO LUCIDO
POLISHED CHROME

WMN719.096



96	130	23	34

- OOT4 > BIANCO VINTAGE ARGENTO
WHITE VINTAGE SILVER
- OOR3 > ARGENTO NOTTINGHAM
NOTTINGHAM SILVER
- OOF7 > VERNICIATO NICHEL SATINATO
VARNISHED NICKEL SATINED
- OOE8 > ARGENTO VECCHIO BRILLANTE
SHINY OLD SILVER
- OOT5 > AVORIO VINTAGE ORO
IVORY VINTAGE GOLD
- OOGP > PLACCATO ORO
GOLD PLATED

WMN719.064



64	96	22	34

WP0719.000



-	35	20	37

- OOR4 > ORO ROMA
ROMA GOLD
- OOR8 > ORO MILANO
MILANO GOLD
- OOA8 > ORVAL
ORVAL
- OOD1 > ANTICA FIRENZE
ANTIQUE FLORENCE
- OOC2 > RUSTIKALL AVORIO
RUSTIKALL IVORY

linea Decor

SERIE 142



WMN142.128



WMN142.096

FINITURE / FINISHING



OOD1 > ANTICA FIRENZE
ANTIQUE FLORENCE



OOE8 > ARGENTO VECCHIO BRILLANTE
SHINY OLD SILVER



WMN142.128

WMN142.096

⊕ ⊖	↔	↑	↓
128	168	25	18
96	132	24	16

linea Decor

SERIE 128



WMN128.192
> WMN128.160

WMN128.128

WMN128.096

WMN128.064



WMN128.192

WMN128.160

WMN128.128

WMN128.096

WMN128.064

⊕ ⊖	↔	↑	↓
192	216	28	13
160	184	28	13
128	152	26	13
96	120	25	13
64	88	22	13

FINITURE / FINISHING



OOD1 > ANTICA FIRENZE
ANTIQUE FLORENCE



OOE8 > ARGENTO VECCHIO BRILLANTE
SHINY OLD SILVER

WMN132.160



WMN132.128

WMN132.096

WMN132.064

linea Decor

SERIE 132



WMN132.160
WMN132.128
WMN132.096
WMN132.064

160	186	28	14
128	154	28	14
96	122	25	14
64	90	21	14

FINITURE / FINISHING

- OOD1 > ANTICA FIRENZE
ANTIQUE FLORENCE
- OO11 > ANTICA ROMA
ANTIQUE ROME
- OOA8 > ORVAL
ORVAL
- OOE8 > ARGENTO VECCHIO BRILLANTE
SHINY OLD SILVER



WMN192.160

linea Decor

SERIE 192



WMN192.160

160	224	27	24

FINITURE / FINISHING

- OOD1 > ANTICA FIRENZE
ANTIQUE FLORENCE

linea Decor

SERIE 139



WMN139.128

WMN139.096

WMN139.064



FINITURE / FINISHING

-  OOD1 > ANTICA FIRENZE
ANTIQUE FLORENCE
-  OOE8 > ARGENTO VECCHIO BRILLANTE
SHINY OLD SILVER
-  OOO1 > VERNICIATO ALLUMINIO OPACO
VARNISHED ALUMINIUM MATT
-  OOF7 > VERNICIATO NICHEL SATINATO
VARNISHED NICKEL SATINED



WMN139.128
WMN139.096
WMN139.064

⊕	↔	↑	↓
128	165	26	19
96	134	26	19
64	101	26	19

linea Decor

SERIE 134 - 212



WMN212.128

WMN134.160



FINITURE / FINISHING

-  OOD1 > ANTICA FIRENZE
ANTIQUE FLORENCE



WMN212.128

⊕	↔	↑	↓
128	163	28	17



WMN134.160

⊕	↔	↑	↓
160	194	28	22



WMN223.096

WMN223.064

linea Decor

SERIE 223



WMN223.096
WMN223.064

⊕ ⊕	↔	↑	↓
96	129	28	10
64	97	25	10

FINITURE / FINISHING

-  OOD1 > ANTICA FIRENZE
ANTIQUE FLORENCE
-  OOE8 > ARGENTO VECCHIO BRILLANTE
SHINY OLD SILVER
-  OOO1 > VERNICIATO ALLUMINIO OPACO
VARNISHED ALUMINIUM MATT
-  OOF7 > VERNICIATO NICHEL SATINATO
VARNISHED NICKEL SATINED



WMN102.128

linea Decor

SERIE 102

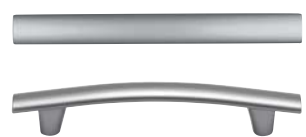

WMN102.128

⊕ ⊕	↔	↑	↓
128	172	32	18

FINITURE / FINISHING

-  OOD1 > ANTICA FIRENZE
ANTIQUE FLORENCE

linea Decor

SERIE 110 - 120 - 122



WMN120.128



WP0110.032



WMN122.128

FINITURE / FINISHING



D1D1 > ANTICA FIRENZE
ANTIQUE FLORENCE



WMN120.128

128	156	30	28



WP0110.032

32	61	22	28



WMN122.128

128	152	30	48

linea Decor

SERIE 220



WMN220.096



WMN220.064

FINITURE / FINISHING



O0D1 > ANTICA FIRENZE
ANTIQUE FLORENCE



O0E8 > ARGENTO VECCHIO BRILLANTE
SHINY OLD SILVER



O0O1 > VERNICIATO ALLUMINIO OPACO
VARNISHED ALUMINIUM MATT



O0F7 > VERNICIATO NICHEL SATINATO
VARNISHED NICKEL SATINED



WMN220.096
WMN220.064

96	112	26	29
64	77	18	18



WMN228.128



WMN228.096

linea Decor

SERIE 228



WMN228.128
WMN228.096

128	141	25	15
96	109	25	15

FINITURE / FINISHING

- OOD1 > ANTICA FIRENZE
ANTIQUE FLORENCE
- OOA8 > ORVAL
ORVAL
- OOE8 > ARGENTO VECCHIO BRILLANTE
SHINY OLD SILVER
- OOC2 > RUSTIKALL AVORIO
RUSTIKALL IVORY



WMN216.096



WP0116.032

linea Decor

SERIE 116 - 216



WMN216.096

96	127	26	24



WP0116.032

32	68	26	24

FINITURE / FINISHING

- OOD1 > ANTICA FIRENZE
ANTIQUE FLORENCE
- OOE8 > ARGENTO VECCHIO BRILLANTE
SHINY OLD SILVER

linea Decor

SERIE 231



WMN231.128

WMN231.096

WMN231.064



FINITURE / FINISHING

-  OOD1 > ANTICA FIRENZE
ANTIQUE FLORENCE
-  OOA8 > ORVAL
ORVAL
-  OOE8 > ARGENTO VECCHIO BRILLANTE
SHINY OLD SILVER
-  OOF7 > VERNICIATO NICHEL SATINATO
VARNISHED NICKEL SATINED
-  OOC2 > RUSTIKALL AVORIO
RUSTIKALL IVORY



WMN231.128

WMN231.096

WMN231.064

⊕	↔	↑	↓
128	156	25	16
96	126	23	16
64	94	21	16

linea Decor

SERIE 114 - 214



WMN214.128

WMN214.096

WMN214.064

WPO114.000



FINITURE / FINISHING

-  OOD1 > ANTICA FIRENZE
ANTIQUE FLORENCE
-  OOE8 > ARGENTO VECCHIO BRILLANTE
SHINY OLD SILVER
-  OOC2 > RUSTIKALL AVORIO
RUSTIKALL IVORY



WMN214.128

WMN214.096

WMN214.064

⊕	↔	↑	↓
128	165	26	18
96	128	24	18
64	92	24	16



WPO114.000

⊕	↔	↑	↓
-	35	24	16



linea Decor

SERIE 115 - 215



WMN215.096

⊕	↔	↑	↓
96	130	24	20



WP0115.000

⊕	↔	↑	↓
-	24	24	24

FINITURE / FINISHING

-  OOD1 > ANTICA FIRENZE
ANTIQUE FLORENCE
-  OOA8 > ORVAL
ORVAL
-  OOE8 > ARGENTO VECCHIO BRILLANTE
SHINY OLD SILVER
-  OOF7 > VERNICIATO NICHEL SATINATO
VARNISHED NICKEL SATINED
-  OOC2 > RUSTIKALL AVORIO
RUSTIKALL IVORY

WMN124.128



WMN124.064



linea Decor

SERIE 124



WMN124.096



WMN124.128
WMN124.096
WMN124.064

⊕	↔	↑	↓
128	138 (13)	50	
96	106 (13)	50	
64	74 (13)	50	

FINITURE / FINISHING

-  OOD1 > ANTICA FIRENZE
ANTIQUE FLORENCE

linea Decor



SERIE 533



WMN533.128

WMN533.096

FINITURE / FINISHING

-  OOD1 > ANTICA FIRENZE
ANTIQUE FLORENCE
-  00A8 > ORVAL
ORVAL
-  00E8 > ARGENTO VECCHIO BRILLANTE
SHINY OLD SILVER
-  00F7 > VERNICIATO NICHEL SATINATO
VARNISHED NICKEL SATINED



WMN533.128

WMN533.096

⊕ ⊖	↔	↑	↓
128	165	23	16
96	132	23	15

linea Decor

SERIE 221



WMN221.096

WMN221.064



FINITURE / FINISHING

-  OOD1 > ANTICA FIRENZE
ANTIQUE FLORENCE
-  00A8 > ORVAL
ORVAL
-  00E8 > ARGENTO VECCHIO BRILLANTE
SHINY OLD SILVER



WMN221.096

WMN221.064

⊕ ⊖	↔	↑	↓
96	114	23	19
64	84	21	17



WMN500.128

WMN500.096

WP0500.000

linea
Decor

SERIE 500



WMN500.128
WMN500.096

128	163	28	26
96	130	24	23



WP0500.000

-	31	24	31

FINITURE / FINISHING

-  OOD1 > ANTICA FIRENZE
ANTIQUE FLORENCE
-  OOAS > ORVAL
ORVAL
-  OOE8 > ARGENTO VECCHIO BRILLANTE
SHINY OLD SILVER
-  OOC2 > RUSTIKALL AVORIO
RUSTIKALL IVORY



WMN501.128

WMN501.096

WP0501.000

linea
Decor

SERIE 501



WMN501.128
WMN501.096

128	163	28	26
96	128	24	23



WP0501.000

-	31	24	31

FINITURE / FINISHING

-  OOD1 > ANTICA FIRENZE
ANTIQUE FLORENCE
-  OOAS > ORVAL
ORVAL
-  OOE8 > ARGENTO VECCHIO BRILLANTE
SHINY OLD SILVER
-  OOC2 > RUSTIKALL AVORIO
RUSTIKALL IVORY

linea Decor

SERIE 226



WMN226.192

WMN226.128

WMN226.096

WPO226.024

WPO226.018

FINITURE / FINISHING

-  OOD1 > ANTICA FIRENZE
ANTIQUE FLORENCE
-  OOA8 > ORVAL
ORVAL
-  OOE8 > ARGENTO VECCHIO BRILLANTE
SHINY OLD SILVER
-  OOC2 > RUSTIKALL AVORIO
RUSTIKALL IVORY



WMN226.192
WMN226.128
WMN226.096

⊕ ⊕	↔	↑	↓
192	210	22	18
128	146	22	18
96	114	22	18



WPO226.024
WPO226.018

⊕ ⊕	↔	↑	↓
-	24	22	24
-	18	22	18

linea Decor

SERIE 118 - 218



WMN218.096

WMN218.064

WPO118.000

FINITURE / FINISHING

-  OOD1 > ANTICA FIRENZE
ANTIQUE FLORENCE
-  OOE8 > ARGENTO VECCHIO BRILLANTE
SHINY OLD SILVER
-  OOC2 > RUSTIKALL AVORIO
RUSTIKALL IVORY



WMN218.096
WMN218.064

⊕ ⊕	↔	↑	↓
96	136	25	16
64	101	25	16



WPO118.000

⊕ ⊕	↔	↑	↓
-	45	22	16



WMN227.096

linea Decor

SERIE 227



WMN227.096

96	146	24	20

FINITURE / FINISHING

- OOD1 > ANTICA FIRENZE
ANTIQUE FLORENCE
- OOA8 > ORVAL
ORVAL
- OOE8 > ARGENTO VECCHIO BRILLANTE
SHINY OLD SILVER



WMN5072/OA

WMN5072/OB

linea Decor

SERIE 5072



WMN5072/OA
WMN5072/OB

96	131	28	22
64	95	24	14

FINITURE / FINISHING

- OOD1 > ANTICA FIRENZE
ANTIQUE FLORENCE
- OOE8 > ARGENTO VECCHIO BRILLANTE
SHINY OLD SILVER
- OOO1 > VERNICIATO ALLUMINIO OPACO
VARNISHED ALUMINIUM MATT
- OOF7 > VERNICIATO NICHEL SATINATO
VARNISHED NICKEL SATINED

linea Decor

SERIE 229



WMN229.096



WP0229.030

FINITURE / FINISHING



OOD1 > ANTICA FIRENZE
ANTIQUE FLORENCE



OOE8 > ARGENTO VECCHIO BRILLANTE
SHINY OLD SILVER



WMN229.096

96	115	20	20



WP0229.030

-	30	22	30

linea Decor

SERIE 230



WMN230.128



WMN230.096

FINITURE / FINISHING



OOD1 > ANTICA FIRENZE
ANTIQUE FLORENCE



OOA8 > ORVAL
ORVAL



OOE8 > ARGENTO VECCHIO BRILLANTE
SHINY OLD SILVER



WMN230.128

128	148	24	16

WMN230.096

96	118	23	16



WMN133.128



WMN133.096



WMN133.064

linea Decor

SERIE 133



WMN133.128
WMN133.096
WMN133.064

⊕ ⊕	↔	↑	↓
128	158	26	14
96	126	26	14
64	94	22	12

FINITURE / FINISHING

-  OOD1 > ANTICA FIRENZE
ANTIQUE FLORENCE
-  OOA8 > ORVAL
ORVAL
-  OOE8 > ARGENTO VECCHIO BRILLANTE
SHINY OLD SILVER
-  OOO1 > VERNICIATO ALLUMINIO OPACO
VARNISHED ALUMINIUM MATT
-  OOF7 > VERNICIATO NICHEL SATINATO
VARNISHED NICKEL SATINED



WMN504.128



WMN504.096



WP0504.032

linea Decor

SERIE 504



WMN504.128
WMN504.096

⊕ ⊕	↔	↑	↓
128	162	26	16
96	132	26	16



WP0504.032

⊕ ⊕	↔	↑	↓
32	72	26	16

FINITURE / FINISHING

-  OOD1 > ANTICA FIRENZE
ANTIQUE FLORENCE
-  OOA8 > ORVAL
ORVAL
-  OOE8 > ARGENTO VECCHIO BRILLANTE
SHINY OLD SILVER
-  OOC2 > RUSTIKALL AVORIO
RUSTIKALL IVORY

linea Decor

SERIE 222



WMN222.096

WP0222.032

FINITURE / FINISHING

-  OOD1 > ANTICA FIRENZE
ANTIQUE FLORENCE
-  OOA8 > ORVAL
ORVAL
-  OOE8 > ARGENTO VECCHIO BRILLANTE
SHINY OLD SILVER
-  OOC2 > RUSTIKALL AVORIO
RUSTIKALL IVORY



WMN222.096

96	138	24	20



WP0222.032

32	58	22	20

linea Decor

SERIE 224



WMN224.096

WP0224.016

FINITURE / FINISHING

-  OOD1 > ANTICA FIRENZE
ANTIQUE FLORENCE
-  OOA8 > ORVAL
ORVAL
-  OOE8 > ARGENTO VECCHIO BRILLANTE
SHINY OLD SILVER
-  OOC2 > RUSTIKALL AVORIO
RUSTIKALL IVORY



WMN224.096

96	111	24	20



WP0224.016

16	42	24	20



WMN232.096

WP0232.032

linea Decor

SERIE 232



WMN232.096

96	138	24	20



WP0232.032

32	58	22	20

FINITURE / FINISHING

- OOD1 > ANTICA FIRENZE
ANTIQUE FLORENCE
- OOA8 > ORVAL
ORVAL
- OOE8 > ARGENTO VECCHIO BRILLANTE
SHINY OLD SILVER
- OOC2 > RUSTIKALL AVORIO
RUSTIKALL IVORY



WMN225.096

WP0225.016

linea Decor

SERIE 225



WMN225.096

96	132	24	20



WP0225.016

16	40	22	20

FINITURE / FINISHING

- OOD1 > ANTICA FIRENZE
ANTIQUE FLORENCE
- OOA8 > ORVAL
ORVAL
- OOE8 > ARGENTO VECCHIO BRILLANTE
SHINY OLD SILVER
- OOC2 > RUSTIKALL AVORIO
RUSTIKALL IVORY

linea Decor

SERIE 515



WMN515.128



WMN515.096



WP0515.000



FINITURE / FINISHING

-  OOD1 > ANTICA FIRENZE
ANTIQUE FLORENCE
-  OOAB > ORVAL
ORVAL
-  OOE8 > ARGENTO VECCHIO BRILLANTE
SHINY OLD SILVER
-  OOC2 > RUSTIKALL AVORIO
RUSTIKALL IVORY



WMN515.128
WMN515.096

ϕ	\leftrightarrow	\updownarrow	\updownarrow
128	162	23	34
96	130	23	34



WP0515.000

ϕ	\leftrightarrow	\updownarrow	\updownarrow
-	40	27	42

linea Decor

SERIE 514



WMN514.128



WMN514.096

WP0514.000



FINITURE / FINISHING

-  OOD1 > ANTICA FIRENZE
ANTIQUE FLORENCE
-  OOAB > ORVAL
ORVAL
-  OOE8 > ARGENTO VECCHIO BRILLANTE
SHINY OLD SILVER
-  OOC2 > RUSTIKALL AVORIO
RUSTIKALL IVORY

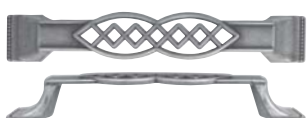

WMN514.128
WMN514.096

ϕ	\leftrightarrow	\updownarrow	\updownarrow
128	168	23	26
96	132	23	26



WP0514.000

ϕ	\leftrightarrow	\updownarrow	\updownarrow
-	56	23	26



WMN516.128



WMN516.096

linea Decor

SERIE 516



WMN516.128
WMN516.096

Φ	↔	↑	↓
128	158	21	55
96	128	21	55

FINITURE / FINISHING

-  OOD1 > ANTICA FIRENZE
ANTIQUE FLORENCE
-  OOA8 > ORVAL
ORVAL
-  OOE8 > ARGENTO VECCHIO BRILLANTE
SHINY OLD SILVER
-  OOC2 > RUSTIKALL AVORIO
RUSTIKALL IVORY



WMN516.MNA



WBC518.000



WCH7115/42



WMN516.MNB

linea Decor

SERIE 516MN



WBC518.000

Φ	↔	↑	↓
-	24	-	58



WCH7115/42

↔	↑	↓	∅
42	36	75	6

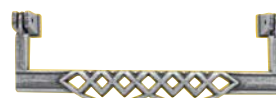

WMN516.MNA
WMN516.MNB

Φ	↔	↑	↓
128	140	18	42
96	108	18	42

FINITURE / FINISHING

-  OOD1 > ANTICA FIRENZE
ANTIQUE FLORENCE
-  OOA8 > ORVAL
ORVAL
-  OOE8 > ARGENTO VECCHIO BRILLANTE
SHINY OLD SILVER
-  OOC2 > RUSTIKALL AVORIO
RUSTIKALL IVORY

linea Decor

SERIE 534



WMN534.128



WMN534.096







FINITURE / FINISHING

-  OOD1 > ANTICA FIRENZE
ANTIQUE FLORENCE
-  OOA8 > ORVAL
ORVAL
-  OOE8 > ARGENTO VECCHIO BRILLANTE
SHINY OLD SILVER
-  OOF7 > VERNICIATO NICHEL SATINATO
VARNISHED NICKEL SATINED



WMN534.128

WMN534.096

			
128	140	24	19
96	108	23	17

linea Decor

SERIE 532



WMN532.128



WMN532.096







FINITURE / FINISHING

-  OOD1 > ANTICA FIRENZE
ANTIQUE FLORENCE
-  OOA8 > ORVAL
ORVAL
-  OOE8 > ARGENTO VECCHIO BRILLANTE
SHINY OLD SILVER



WMN532.128

WMN532.096

			
128	154	24	32
96	120	23	32



WMN5238/0A

WMN5239/0A

WMN5238/0B

WMN5239/0B

linea Decor

SERIE 5238 - 5239



WMN5238/0A
WMN5238/0B

⊕	↔	↑	↓
96	143	30	20
64	102	23	17



WMN5239/0A
WMN5239/0B

⊕	↔	↑	↓
96	118	26	11
64	86	20	11

FINITURE / FINISHING

-  00D1 > ANTICA FIRENZE
ANTIQUE FLORENCE
-  00E8 > ARGENTO VECCHIO BRILLANTE
SHINY OLD SILVER

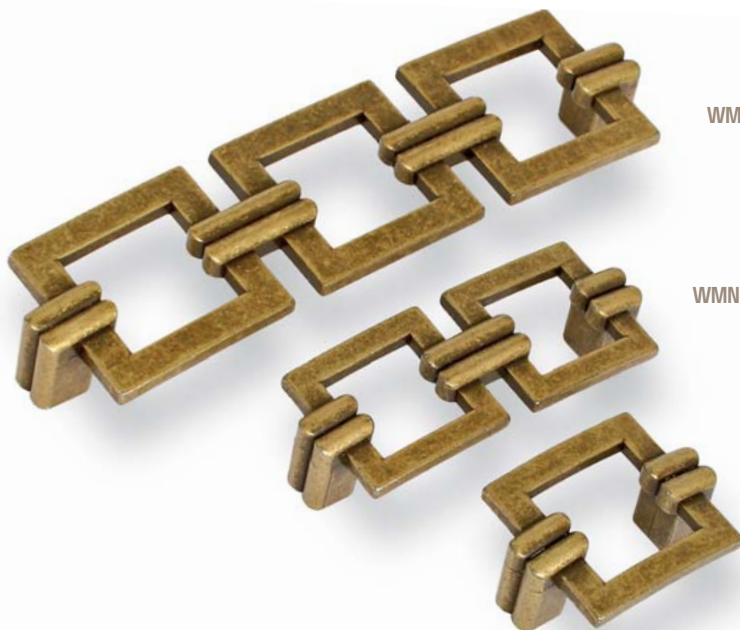

WMN040.128

WMN040.064

WP0040.032

linea Decor

SERIE 040

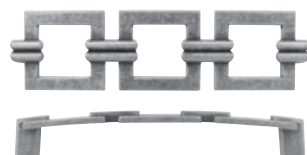

WMN040.128
WMN040.064



⊕	↔	↑	↓
128	140	23	38
64	77	20	32



WP0040.032

⊕	↔	↑	↓
32	44	20	35

FINITURE / FINISHING

-  00D1 > ANTICA FIRENZE
ANTIQUE FLORENCE
-  00A8 > ORVAL
ORVAL
-  00E8 > ARGENTO VECCHIO BRILLANTE
SHINY OLD SILVER

linea Decor

SERIE 39039 - 39045





X39045



X39039

FINITURE / FINISHING

-  0092 > VERNICIATO CANNA DI FUCILE
VARNISHED GUN METAL GRAY
-  00A5 > NERO SFUMATO
SHADED BLACK



X39045

76	95	-	52



X39039

-	36	-	96



WMN5091/00

64	84	20	34

linea Decor

SERIE P0112 - 7112 - 8180



FINITURE / FINISHING

-  00D1 > ANTICA FIRENZE
ANTIQUE FLORENCE
-  00E8 > ARGENTO VECCHIO BRILLANTE
SHINY OLD SILVER
-  00O1 > VERNICIATO ALLUMINIO OPACO
VARNISHED ALUMINIUM MATT
-  00F7 > VERNICIATO NICHEL SATINATO
VARNISHED NICKEL SATINED

WBC8180/00

> WP0112.032
WP0112.064

WCH7112/46



WP0112.032
WP0112.064

32	42	22	8
64	74	22	8



WBC8180/00

-	25	-	60



WCH7112/46

46	34	59	6



linea Decor

SERIE 5090 - 5091
5092 - 5230



FINITURE / FINISHING

- OOD1 > ANTICA FIRENZE
ANTIQUE FLORENCE
- OOA8 > ORVAL
ORVAL
- OOE8 > ARGENTO VECCHIO BRILLANTE
SHINY OLD SILVER
- OOF7 > VERNICIATO NICHEL SATINATO
VARNISHED NICKEL SATINED



linea Decor

SERIE 5030 - 5031 - 5094

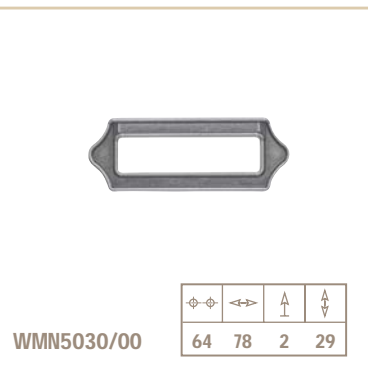

FINITURE / FINISHING

- OOD1 > ANTICA FIRENZE
ANTIQUE FLORENCE
- OOA8 > ORVAL
ORVAL
- OOE8 > ARGENTO VECCHIO BRILLANTE
SHINY OLD SILVER
- OOF7 > VERNICIATO NICHEL SATINATO
VARNISHED NICKEL SATINED

linea Decor

SERIE 2024 - 6000 - 6016



WPO2024/35



WPO2024/30



WPO2024/25



WPO6000/30



WPO6000/24



WPO6016/00



WPO2024/35
WPO2024/30
WPO2024/25

⊕	↔	↑	∅
-	-	27	35
-	-	24	30
-	-	21	25



WPO6000/30
WPO6000/24

⊕	↔	↑	∅
-	-	21	30
-	-	20	24



WPO6016/00

⊕	↔	↑	↓
-	36	19	27

FINITURE / FINISHING



OOD1 > ANTICA FIRENZE
ANTIQUE FLORENCE



OOA8 > ORVAL
ORVAL



OOE8 > ARGENTO VECCHIO BRILLANTE
SHINY OLD SILVER



OOF7 > VERNICIATO NICHEL SATINATO
VARNISHED NICKEL SATINATED



WP02025/35



WP02025/25



WP02025/30



WP02031/35



WP02031/25



WP02031/30

linea Decor

SERIE 2025 - 2031



WP02025/35
WP02025/30
WP02025/25

⊕	↔	↑	∅
-	-	28	35
-	-	25	30
-	-	22	25



WP02031/35
WP02031/30
WP02031/25

⊕	↔	↑	∅
-	-	31	35
-	-	27	30
-	-	24	25

FINITURE / FINISHING

-  00D1 > ANTICA FIRENZE
ANTIQUE FLORENCE
-  00A8 > ORVAL
ORVAL
-  00E8 > ARGENTO VECCHIO BRILLANTE
SHINY OLD SILVER
-  00F7 > VERNICIATO NICHEL SATINATO
VARNISHED NICKEL SATINATED



 MANIGLIE
HANDLES

> PAGE 179

 CHIAVI
KEYS

> PAGE 236

 POMOLI
KNOBS

> PAGE 226

 BOCCHETTE
ESCUTCHEONS

> PAGE 240

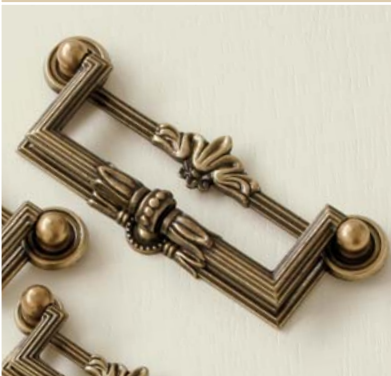
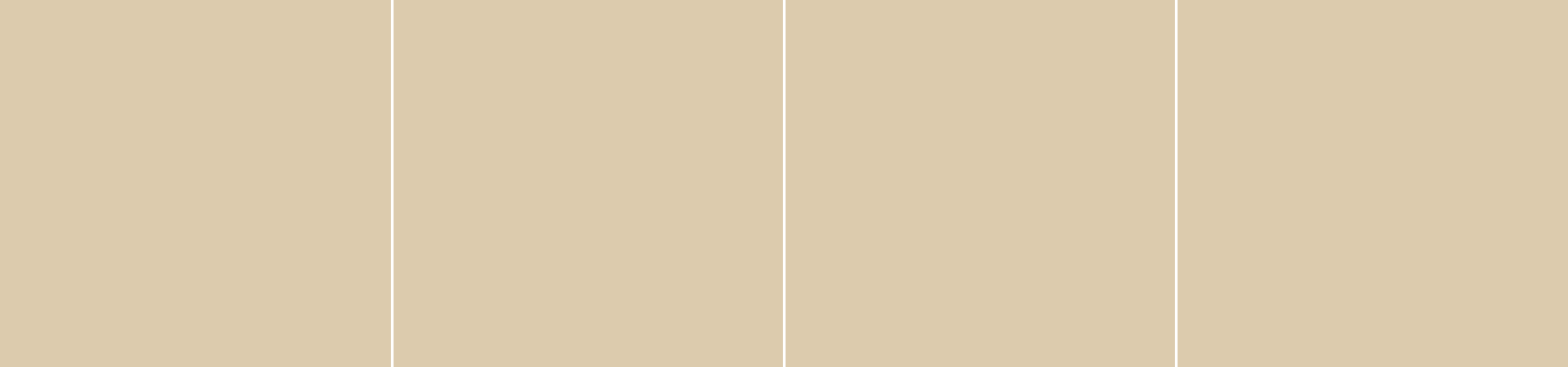



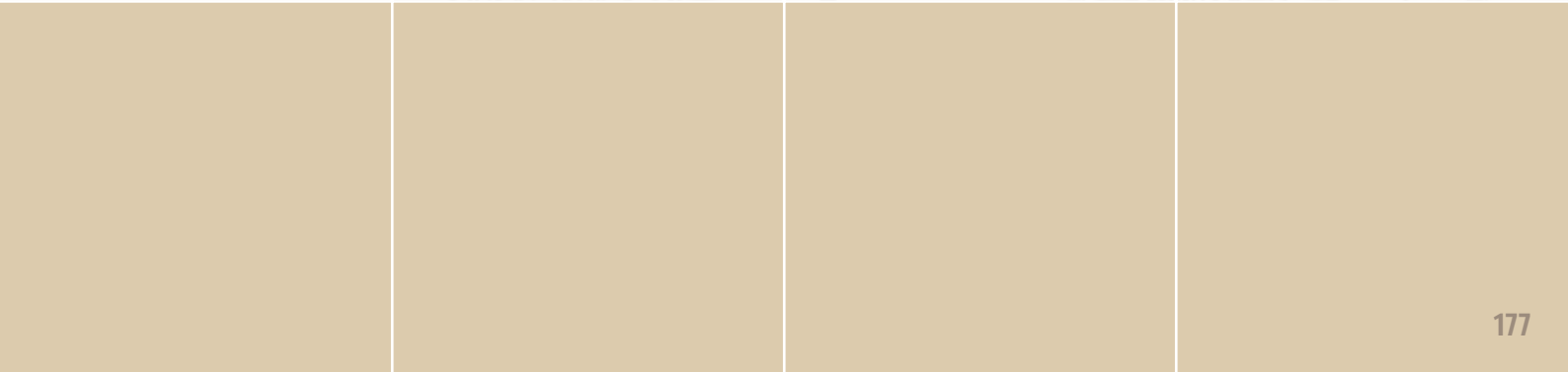
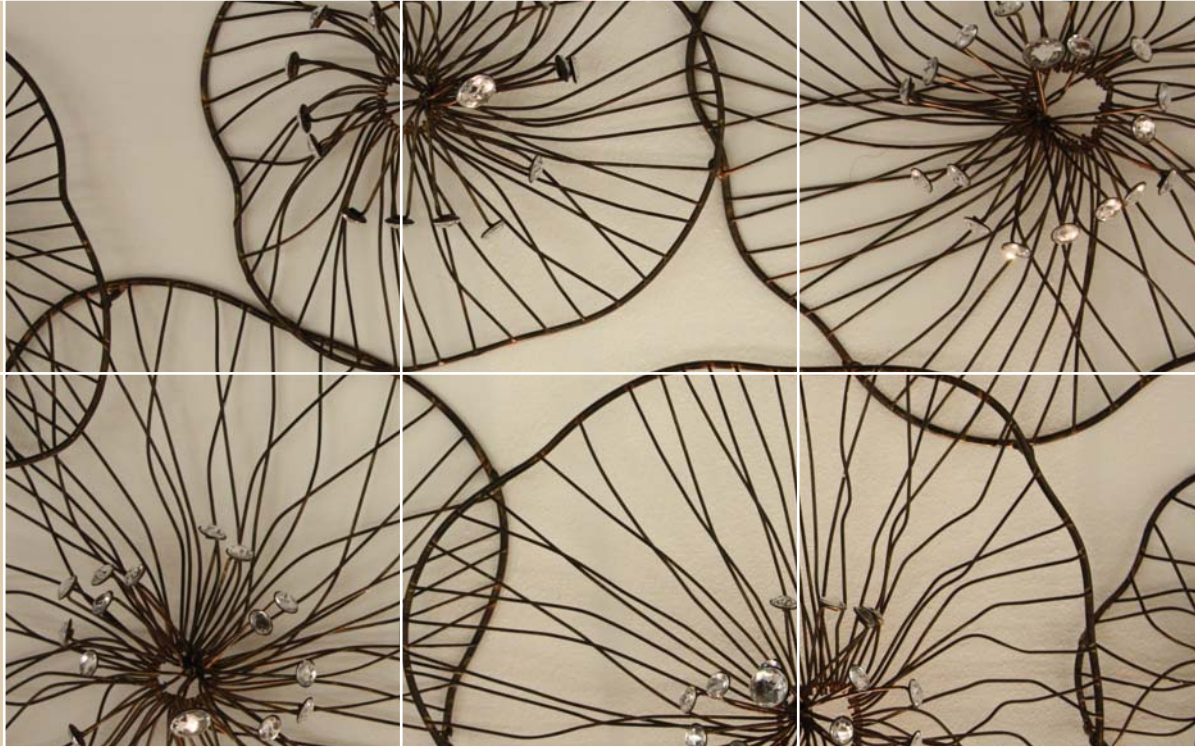









Classic



FINITURE LINEA CLASSIC

CLASSIC FINISHES

 F7 > VERNICIATO NICHEL SATINATO VARNISHED NICKEL SATINED	 15 > ARGENTO VECCHIO OLD SILVER	 C1 > RAME ANTICO COUNTRY ANTIQUÉ COPPER COUNTRY
 23 > NICHEL SATINATO NICKEL SATINED	 E8 > ARGENTO VECCHIO BRILLANTE SHINY OLD SILVER	 27 > RAME ANTICO ANTIQUÉ COPPER
 22 > NICHEL LUCIDO POLISHED NICKEL	 24 > NICHEL VECCHIO OLD NICKEL	 20 > OTTONE LUCIDO A MANO HAND POLISHED BRASS
 D5 > ARGENTO GRAFFIATO SCRATCHED SILVER	 B9 > NICHEL VECCHIO COUNTRY OLD NICKEL COUNTRY	 10 > PLACCATO ORO GOLD PLATED

 06 > ORO LUCIDO POLISHED BRASS PLATED	 50 > ORO FRANCESE ECONOMICO ECONOMIC FRENCH GOLD	 04 > BRONZO LUCIDO POLISHED BRONZE
 36 > ORO LUCIDO ECONOMICO ECONOMIC POLISHED BRASS	 A8 > ORVAL ORVAL	 X4 > BRONZO PARIGI PARIS BRONZE
 21 > ORO FUSIONE ORO FUSIONE	 B8 > ORVAL MATT ORVAL MATT	 01 > PATINATO ANTICO ANTIQUÉ PATINATED
 30 > ORO FRANCESE FRENCH GOLD	 03 > BRONZO SFUMATO SHADED BRONZE	 A9 > PATINATO COUNTRY PATINATED COUNTRY

 80 > ANTICA ROMA ANTIQUÉ ROME	 08 > NERO OPACO DULL BLACK	 19 > FERRO VECCHIO OLD IRON
 D1 > ANTICA FIRENZE ANTIQUÉ FLORENCE	 07 > NERO NITRO NITRO BLACK	 14 > FERRO BRUNITO BURNISHED IRON
 B1 > BRONZO COUNTRY BRONZE CONUNTRY	 12 > FERRO NATURALE NATURAL IRON	 42 > SIMILOSSO BONE IMITATION
 A6 > NERO ALPI BLACK ALPS	 16 > FERRO OTTONATO PATINATO ANTIQUÉ PATINED BRASSED IRON	 43 > NOCE ANTICO ANTIQUÉ WALNUT

SIMBOLOGIA

SYMBOLOLOGY



INTERASSE
DISTANCE BETWEEN CENTRES



ALTEZZA
HEIGHT



LUNGHEZZA
LENGHT



LARGHEZZA
WIDTH





5118/A



5118/B



8105/B0



2028/35



2028/30



7017/35
> 7017/42
7017/55



2028/25

linea Classic



	⊕	↔	↑	↓	Material
2028/25	-	25	22	-	Brass-Zn
2028/30	-	30	25	-	Brass-Zn
2028/35	-	35	28	-	Brass-Zn
5029/A	96	138	-	46	Zamak
5029/B	64	112	-	40	Zamak
5029/C	-	79	-	26	Zamak
5118/A	-	60	-	61	Zamak
5118/B	-	45	-	46	Zamak
7009/22	6	31	-	61	Zamak



5029/A



5029/B



5029/C



2028/35

7009/22
7009/33
> 7009/42
7009/46
7009/53



8122



2028/30



8026



2028/25

	⊕	↔	↑	↓	Material
7009/33	6	31	-	72	Zamak
7009/42	6	31	-	81	Zamak
7009/46	6	31	-	85	Zamak
7009/53	6	31	-	92	Zamak
7017/35	6	34	-	77	Zamak
7017/42	6	34	-	84	Zamak
7017/55	6	34	-	97	Zamak
8026	-	60	-	29	Zamak
8105/B0	-	37	-	37	Zamak

	⊕	↔	↑	↓	Material
8122	-	28	-	60	Zamak

FINITURE / FINISHING

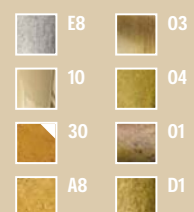

linea Classic



	⊕	↔	↑	↓	Material
2027/25	-	25	22	-	Brass-Zn
2027/30	-	30	24	-	Brass-Zn
2027/35	-	35	29	-	Brass-Zn
2030/25	-	25	19	-	Brass-Zn
2030/30	-	30	21	-	Brass-Zn
2030/35	-	35	24	-	Brass-Zn
5113/A	96	115	-	42	Zamak
5113/B	64	84	-	29	Zamak
5115	-	20	-	74	Zamak



5144/A



5144/B



2027/35



8102/B0



5115



2027/30



7020/33
> 7020/42
7020/46
7020/53



5115/B



2027/25

	⊕	↔	↑	↓	Material
5115/B	-	20	-	62	Zamak
5144/A	96	116	-	50	Zamak
5144/B	64	85	-	40	Zamak
7020/33	6	28	-	67	Zamak
7020/42	6	28	-	76	Zamak
7020/46	6	28	-	80	Zamak
7020/53	6	28	-	87	Zamak
8100/B0	-	19	-	86	Zamak
8102/B0	-	25	-	39	Zamak



5133/A



5133/B



8104/B0

	⊕	↔	↑	↓	Material
8103/B0	-	23	-	45	Zamak
8104/B0	-	58	-	24	Zamak



2030/35



8103/B0



5115



2030/30



7020/33
> 7020/42
7020/46
7020/53

5115/B



8100/B0



2030/25

FINITURE / FINISHING

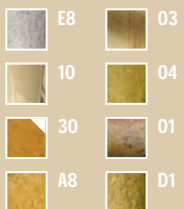



5136



5137



5112/B0



8101/B0



5138



5139



5113/B0

linea Classic



	⊕⊗	↔	↑	↓	Material
5107/B0	-	27	-	158	Zamak
5107/FR	-	27	-	158	Zamak
5108/B0	-	21	-	124	Zamak
5108/FR	-	21	-	124	Zamak
5112/B0	-	28	-	154	Zamak
5113/B0	-	22	-	123	Zamak
5128	-	27	-	158	Zamak
5129	-	27	-	158	Zamak
5130	-	21	-	124	Zamak



5128



5129



5107/B0



5107/FR



5130



5131



5108/B0



5108/FR

	⊕⊗	↔	↑	↓	Material
5131	-	21	-	124	Zamak
5136	-	28	-	154	Zamak
5137	-	28	-	154	Zamak
5138	-	22	-	123	Zamak
5139	-	22	-	123	Zamak
8101/B0	-	19	-	82	Zamak

FINITURE / FINISHING

	E8		O3
	I0		O4
	S0		O1
	A8		D1

linea Classic



	⊕	↔	↑	↓	Material
2030/25	-	25	19	-	Brass-Zn
2030/30	-	30	21	-	Brass-Zn
2030/35	-	35	24	-	Brass-Zn
5015/A	-	58	-	71	Zamak
5015/B	-	46	-	56	Zamak
5021/A	-	57	-	-	Zamak
5021/B	-	40	-	-	Zamak
6010/17	-	17	14	-	Zamak
6010/24	-	24	17	-	Zamak



5015/A



5015/B



6010/34



6010/29



6010/24



6010/17



8031



7004/22
7004/33
> 7004/42
7004/46
7004/53

	⊕	↔	↑	↓	Material
6010/29	-	29	21	-	Zamak
6010/34	-	34	22	-	Zamak
7004/22	6	22	-	59	Zamak
7004/33	6	22	-	69	Zamak
7004/42	6	22	-	79	Zamak
7004/46	6	22	-	83	Zamak
7004/53	6	22	-	90	Zamak
7020/33	6	28	-	67	Zamak
7020/42	6	28	-	76	Zamak



5021/A



5021/B

	⊕	↔	↑	↓	Material
7020/46	6	28	-	80	Zamak
7020/53	6	28	-	87	Zamak
8031	-	31	-	39	Zamak
8032	-	30	-	-	Zamak



2030/35



8032



2030/30



2030/25



7020/33
> 7020/42
7020/46
7020/53

FINITURE / FINISHING

	E8		03
	10		04
	30		01
	A8		D1



5016/A



5016/B



5016/C



6010/34



6010/29



6010/24



6010/17



8081



7020/33
> 7020/42
7020/46
7020/53

linea Classic



	⊕	↔	↑	↓	Material
5016/A	-	66	-	58	Zamak
5016/B	-	56	-	49	Zamak
5016/C	-	49	-	48	Zamak
5034/A	64	81	-	77	Zamak
5034/B	-	62	-	57	Zamak
6010/17	-	17	14	-	Zamak
6010/24	-	24	17	-	Zamak
6010/29	-	29	21	-	Zamak
6010/34	-	34	22	-	Zamak



5034/A



5034/B



6015/37



8087



6015/30



6015/24



7004/22
7004/33
> 7004/42
7004/46
7004/53

	⊕	↔	↑	↓	Material
6015/24	-	24	19	-	Zamak
6015/30	-	30	20	-	Zamak
6015/37	-	37	20	-	Zamak
7004/22	6	22	-	59	Zamak
7004/33	6	22	-	70	Zamak
7004/42	6	22	-	79	Zamak
7004/46	6	22	-	83	Zamak
7004/53	6	22	-	90	Zamak
7020/33	6	28	-	67	Zamak

	⊕	↔	↑	↓	Material
7020/42	6	28	-	76	Zamak
7020/46	6	28	-	80	Zamak
7020/53	6	28	-	87	Zamak
8081	-	49	-	43	Zamak
8087	-	36	-	35	Zamak

FINITURE / FINISHING

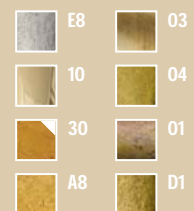

linea Classic



	⊕	↔	↑	↓	Material
2026/25	-	25	24	-	Brass-Zn
2026/30	-	30	27	-	Brass-Zn
2026/35	-	35	31	-	Brass-Zn
2027/25	-	25	22	-	Brass-Zn
2027/30	-	30	24	-	Brass-Zn
2027/35	-	35	29	-	Brass-Zn
5102/A	96	131	-	47	Zamak
5102/B	-	110	-	40	Zamak
5102/C	64	94	-	31	Zamak

	⊕	↔	↑	↓	Material
5115	-	20	-	74	Zamak
5115/B	-	20	-	62	Zamak
5132/A	96	114	-	44	Zamak
5132/B	64	76	-	29	Zamak
7020/33	6	28	-	67	Zamak
7020/42	6	28	-	76	Zamak
7020/46	6	28	-	80	Zamak
7020/53	6	28	-	87	Zamak
7023/35	6	32	-	65	Zamak

	⊕	↔	↑	↓	Material
7023/42	6	32	-	72	Zamak
7023/55	6	32	-	85	Zamak
8029	-	26	-	47	Zamak
8103/B0	-	23	-	45	Zamak
8104/B0	-	58	-	24	Zamak

FINITURE / FINISHING

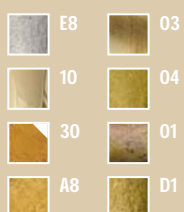

5132/A



5132/B



8104/B0



8103/B0



2027/35



2027/30



5115



2027/25



7020/33
> 7020/42
7020/46
7020/53



5115/B



5102/A



5102/B



5102/C



2026/35



2026/30



8029



7023/35
> 7023/42
7023/55



2026/25





5136



5137



5112/B0



8101/B0



5138



5139



5113/B0

linea Classic



	⊕ ⊕	↔	↑	↓	Material
5104	-	25	-	136	Zamak
5103/A	-	25	-	136	Zamak
5103/B	-	18	-	98	Zamak
5105	-	20	-	73	Zamak
5106	-	20	-	58	Zamak
5112/B0	-	28	-	154	Zamak
5113/B0	-	22	-	123	Zamak
5136	-	28	-	154	Zamak
5137	-	28	-	154	Zamak



5104



5103/A



5103/B

	⊕ ⊕	↔	↑	↓	Material
5138	-	22	-	123	Zamak
5139	-	22	-	123	Zamak
8101/B0	-	19	-	82	Zamak



5105



5106

FINITURE / FINISHING

	E8		O3
	10		O4
	30		O1
	A8		D1

linea Classic



	⊕	↔	↑	↓	Material
2027/25	-	25	22	-	Brass-Zn
2027/30	-	30	24	-	Brass-Zn
2027/35	-	35	29	-	Brass-Zn
5039/A	96	115	-	40	Zamak
5039/B	-	100	-	37	Zamak
5039/C	64	83	-	30	Zamak
5057	-	20	-	69	Zamak
5057/B	-	20	-	60	Zamak
5107/B0	-	27	-	158	Zamak

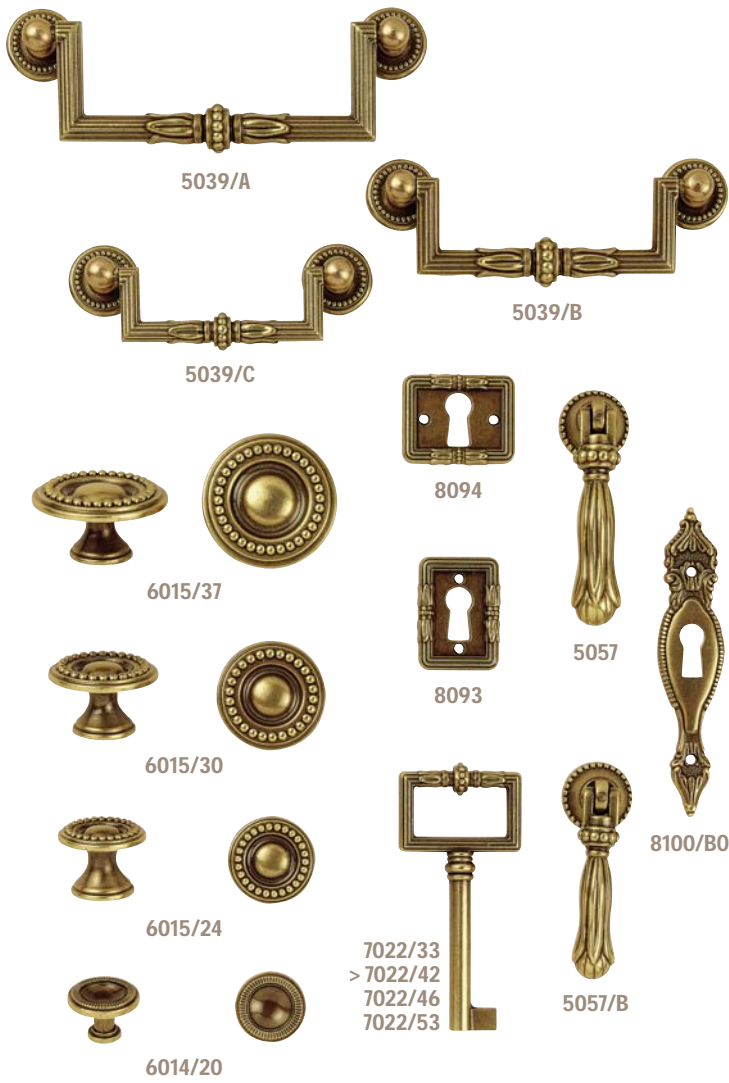

	⊕	↔	↑	↓	Material
5108/B0	-	21	-	124	Zamak
5140/A	96	117	-	49	Zamak
5140/B	64	85	-	40	Zamak
6014/20	-	20	14	-	Zamak
6015/24	-	24	19	-	Zamak
6015/30	-	30	20	-	Zamak
6015/37	-	37	20	-	Zamak
7022/33	6	37	-	65	Zamak
7022/42	6	37	-	74	Zamak



	⊕	↔	↑	↓	Material
7022/46	6	37	-	78	Zamak
7022/53	6	37	-	85	Zamak
8093	-	23	-	31	Zamak
8094	-	32	-	25	Zamak
8100/B0	-	19	-	86	Zamak

FINITURE / FINISHING

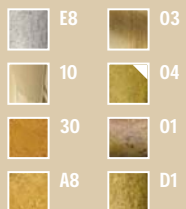



5120



5121



5107/B0



5107/FR



5122



5123



5108/B0



5108/FR

linea Classic



	⊕	↔	↑	↓	Material
5107/B0	-	27	-	158	Zamak
5107/FR	-	27	-	158	Zamak
5108/B0	-	21	-	124	Zamak
5108/FR	-	21	-	124	Zamak
5112/B0	-	28	-	154	Zamak
5113/B0	-	22	-	123	Zamak
5120	-	27	-	158	Zamak
5121	-	27	-	158	Zamak
5122	-	21	-	124	Zamak



5146



5147



5112/B0



8101/B0



5148



5149



5113/B0

	⊕	↔	↑	↓	Material
5123	-	21	-	124	Zamak
5146	-	28	-	154	Zamak
5147	-	28	-	154	Zamak
5148	-	22	-	123	Zamak
5149	-	22	-	123	Zamak
8101/B0	-	19	-	82	Zamak

FINITURE / FINISHING

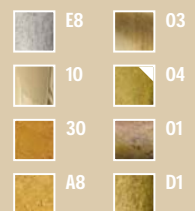

linea Classic



	⊕	↔	↑	↓	Material
2027/25	-	25	22	-	Brass-Zn
2027/30	-	30	24	-	Brass-Zn
2027/35	-	35	29	-	Brass-Zn
5053	-	20	-	73	Zamak
5053/B	-	20	-	61	Zamak
5055/A	96	114	-	48	Zamak
5055/B	64	83	-	34	Zamak
5115	-	20	-	74	Zamak
5115/B	-	20	-	62	Zamak

	⊕	↔	↑	↓	Material
5135/A	96	117	-	49	Zamak
5135/B	-	108	-	49	Zamak
5135/C	64	85	-	41	Zamak
6014/20	-	20	14	-	Zamak
6015/24	-	24	19	-	Zamak
6015/30	-	30	20	-	Zamak
6015/37	-	37	20	-	Zamak
7003/22	6	22	-	54	Zamak
7003/33	6	22	-	65	Zamak

	⊕	↔	↑	↓	Material
7003/42	6	22	-	74	Zamak
7003/46	6	22	-	78	Zamak
7003/53	6	22	-	85	Zamak
7017/35	6	34	-	77	Zamak
7017/42	6	34	-	82	Zamak
7017/55	6	34	-	97	Zamak
8033	-	25	-	36	Zamak
8034	-	37	-	26	Zamak
8090	-	25	-	36	Zamak

	⊕	↔	↑	↓	Material
8100/B0	-	19	-	86	Zamak
8102/B0	-	25	-	39	Zamak



5055/A

5055/B



6015/37



7003/22
7003/33
> 7003/42
7003/46
7003/53



8090

Ø 19



8100/B0



6015/30



8033



5053



5053/B



6015/24



8034



6014/20



5135/A



5135/B



5135/C



8102/B0



5115



2027/35



7017/35
> 7017/42
7017/55



5115/B



2027/30



2027/25



5124



5125



5107/B0



5107/FR



5126



5127



5108/B0



5108/FR

linea Classic



	⊕⊗	↔	↑	↓	Material
5107/B0	-	27	-	158	Zamak
5107/FR	-	27	-	158	Zamak
5108/B0	-	21	-	124	Zamak
5108/FR	-	21	-	124	Zamak
5112/B0	-	28	-	154	Zamak
5113/B0	-	22	-	123	Zamak
5124	-	27	-	158	Zamak
5125	-	27	-	158	Zamak
5126	-	21	-	124	Zamak



5136



5137



5112/B0



8101/B0



5138



5139



5113/B0

	⊕⊗	↔	↑	↓	Material
5127	-	21	-	124	Zamak
5136	-	28	-	154	Zamak
5137	-	28	-	154	Zamak
5138	-	22	-	123	Zamak
5139	-	22	-	123	Zamak
8101/B0	-	19	-	82	Zamak

FINITURE / FINISHING

	E8		O3
	I0		O4
	S0		O1
	A8		D1

linea
Classic



5220/A

5220/B



5218/A

5218/B



5214/A

5214/B



5212/A

5212/B



5216/A

5216/B

	⊕	↔	↑	↓	Material
5053	-	20	-	73	Zamak
5212/A	96	128	-	44	Zamak
5212/B	64	85	-	29	Zamak
5214/A	96	131	-	51	Zamak
5214/B	64	87	-	35	Zamak
5216/A	96	120	-	53	Zamak
5216/B	64	86	-	37	Zamak
5218/A	96	121	-	52	Zamak
5218/B	64	87	-	40	Zamak

	⊕	↔	↑	↓	Material
5220/A	96	115	-	48	Zamak
5220/B	64	82	-	40	Zamak
6015/24	-	24	19	-	Zamak
6015/30	-	30	20	-	Zamak
6015/37	-	37	20	-	Zamak
7020/33	6	28	-	67	Zamak
7020/42	6	28	-	76	Zamak
7020/46	6	28	-	80	Zamak
7020/53	6	28	-	87	Zamak

	⊕	↔	↑	↓	Material
8033	-	25	-	36	Zamak
8090	-	25	-	36	Zamak

FINITURE / FINISHING

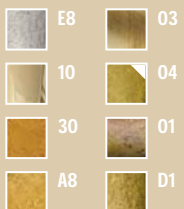



5053



6015/37
> 6015/30
6015/24



8033



8090

Ø 19



7020/33
> 7020/42
7020/46
7020/53



5115



2030/35
> 2030/30
2030/25



8033



7020/33
> 7020/42
7020/46
7020/53



5060



2023/35
> 2023/30
2023/25



8037/SP



7005/22
7005/33
> 7005/42
7005/46
7005/53



5059



> 6022/30
6022/25



8037/SP



7024/33
> 7024/42
7024/46
7024/53



5058



5216/TR



2025/35
> 2025/30
2025/25



8037/SP



7005/22
7005/33
> 7005/42
7005/46
7005/53

linea Classic



	⊕⊕	↔	↑	↓	Material
2023/25	-	25	21	-	Brass-Zn
2023/30	-	30	25	-	Brass-Zn
2023/35	-	35	27	-	Brass-Zn
2025/25	-	25	22	-	Brass-Zn
2025/30	-	30	25	-	Brass-Zn
2025/35	-	35	28	-	Brass-Zn
2030/25	-	25	19	-	Brass-Zn
2030/30	-	30	21	-	Brass-Zn
2030/35	-	35	24	-	Brass-Zn

	⊕⊕	↔	↑	↓	Material
5058	-	20	-	67	Zamak
5059	-	20	-	66	Zamak
5060	-	20	-	67	Zamak
5115	-	20	-	74	Zamak
5216/TR	-	36	-	50	Zamak
6022/25	-	25	20	-	Zamak
6022/30	-	30	20	-	Zamak
7005/22	6	30	-	53	Zamak
7005/33	6	30	-	64	Zamak

	⊕⊕	↔	↑	↓	Material
7005/42	6	30	-	73	Zamak
7005/46	6	30	-	77	Zamak
7005/53	6	30	-	84	Zamak
7024/33	6	36	-	65	Zamak
7024/42	6	36	-	74	Zamak
7024/46	6	36	-	78	Zamak
7024/53	6	36	-	85	Zamak
8037/SP	-	20	-	44	Zamak

FINITURE / FINISHING

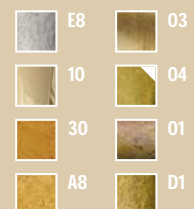

linea
Classic



	⊕	↔	↑	↓	Material
2027/25	-	25	22	-	Brass-Zn
2027/30	-	30	24	-	Brass-Zn
2027/35	-	35	29	-	Brass-Zn
5040/A	96	113	-	50	Zamak
5040/B	64	84	-	40	Zamak
5053	-	20	-	73	Zamak
5053/B	-	20	-	61	Zamak
5115	-	20	-	74	Zamak
5115/B	-	20	-	62	Zamak

	⊕	↔	↑	↓	Material
5141/A	96	129	-	51	Zamak
5141/B	64	86	-	84	Zamak
6014/20	-	20	14	-	Zamak
6015/24	-	24	19	-	Zamak
6015/30	-	30	20	-	Zamak
6015/37	-	37	20	-	Zamak
7003/22	6	22	-	54	Zamak
7003/33	6	22	-	65	Zamak
7003/42	6	22	-	74	Zamak

	⊕	↔	↑	↓	Material
7003/46	6	22	-	78	Zamak
7003/53	6	22	-	85	Zamak
7017/35	6	34	-	77	Zamak
7017/42	6	34	-	84	Zamak
7017/55	6	34	-	97	Zamak
8033	-	25	-	36	Zamak
8034	-	37	-	26	Zamak
8090	-	25	-	36	Zamak
8100/B0	-	19	-	86	Zamak

	⊕	↔	↑	↓	Material
8103/B0	-	23	-	45	Zamak
8104/B0	-	58	-	24	Zamak



5141/A



5141/B



8104/B0



2027/35



8103/B0



5115



2027/30



7017/35
> 7017/42
7017/55



5115/B



2027/25



5040/A



5040/B



6015/37



7003/22
7003/33
> 7003/42
7003/46
7003/53



8090



Ø 19



6015/30



8100/B0



6015/24



8033



5053



6014/20



8034



5053/B



5136



5137



5112/B0



8101/B0



5138



5139



5113/B0

linea Classic



	⊕⊖	↔	↑	↓	Material
5107/B0	-	27	-	158	Zamak
5107/FR	-	27	-	158	Zamak
5108/B0	-	21	-	124	Zamak
5108/FR	-	21	-	124	Zamak
5112/B0	-	28	-	154	Zamak
5113/B0	-	22	-	123	Zamak
5124	-	27	-	158	Zamak
5125	-	27	-	158	Zamak
5126	-	21	-	124	Zamak



5124



5125



5107/B0



5107/FR



5126



5127



5108/B0



5108/FR

	⊕⊖	↔	↑	↓	Material
5127	-	21	-	124	Zamak
5136	-	28	-	154	Zamak
5137	-	28	-	154	Zamak
5138	-	22	-	123	Zamak
5139	-	22	-	123	Zamak
8101/B0	-	19	-	82	Zamak

FINITURE / FINISHING

	E8		O3
	I0		O4
	S0		O1
	A8		D1

linea Classic



	⊕	↔	↑	↓	Material
2027/25	-	25	22	-	Brass-Zn
2027/30	-	30	24	-	Brass-Zn
2027/35	-	35	29	-	Brass-Zn
5057	-	20	-	69	Zamak
5057/B	-	20	-	60	Zamak
5101/A	96	129	-	52	Zamak
5101/B	-	118	-	43	Zamak
5101/C	64	86	-	34	Zamak
5115	-	20	-	74	Zamak



5101/A



5101/C



5101/B



2027/35



8093



5057



8094



2027/30



7022/33
> 7022/42
7022/46
7022/53



5057/B



2027/25

	⊕	↔	↑	↓	Material
5115/B	-	20	-	62	Zamak
5143/A	96	129	-	48	Zamak
5143/B	64	86	-	33	Zamak
7017/35	6	34	-	77	Zamak
7017/42	6	34	-	84	Zamak
7017/55	6	34	-	97	Zamak
7022/33	6	37	-	65	Zamak
7022/42	6	37	-	74	Zamak
7022/46	6	37	-	78	Zamak



5143/A



5143/B



2027/35



8102/B0



5115

	⊕	↔	↑	↓	Material
7022/53	6	37	-	85	Zamak
8093	-	23	-	31	Zamak
8094	-	32	-	25	Zamak
8102/B0	-	25	-	39	Zamak



2027/30



7017/35
> 7017/42
7017/55



5115/B



2027/25

FINITURE / FINISHING





5146



5147



5112/B0



8101/B0



5148



5149



5113/B0

linea Classic



	⊕ ⊕	↔	↑	↓	Material
5112/B0	-	28	-	154	Zamak
5113/B0	-	22	-	123	Zamak
5136	-	28	-	154	Zamak
5137	-	28	-	154	Zamak
5138	-	22	-	123	Zamak
5139	-	22	-	123	Zamak
5146	-	28	-	154	Zamak
5147	-	28	-	154	Zamak
5148	-	22	-	123	Zamak



5136



5137



5112/B0



8101/B0



5138



5139



5113/B0

	⊕ ⊕	↔	↑	↓	Material
5149	-	22	-	123	Zamak
8101/B0	-	19	-	82	Zamak

FINITURE / FINISHING

	E8		O3
	I0		O4
	S0		O1
	A8		D1

linea Classic



	⊕	↔	↑	↓	Material
2027/25	-	25	22	-	Brass-Zn
2027/30	-	30	24	-	Brass-Zn
2027/35	-	35	29	-	Brass-Zn
5026/A	96	115	-	40	Zamak
5026/B	-	98	-	39	Zamak
5026/C	64	78	-	31	Zamak
5057	-	20	-	69	Zamak
5057/B	-	20	-	60	Zamak
5115	-	20	-	74	Zamak

	⊕	↔	↑	↓	Material
5115/B	-	20	-	62	Zamak
5134/A	96	117	-	49	Zamak
5134/B	-	106	-	49	Zamak
5134/C	64	85	-	40	Zamak
7017/35	6	34	-	77	Zamak
7017/42	6	34	-	84	Zamak
7017/55	6	34	-	97	Zamak
7022/33	6	37	-	65	Zamak
7022/42	6	37	-	74	Zamak

	⊕	↔	↑	↓	Material
7022/46	6	37	-	78	Zamak
7022/53	6	37	-	85	Zamak
8093	-	23	-	31	Zamak
8094	-	32	-	25	Zamak
8100/B0	-	19	-	86	Zamak
8102/B	-	25	-	39	Zamak

FINITURE / FINISHING

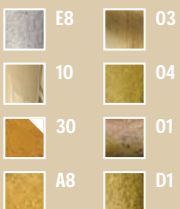

5134/A



5134/B



5134/C



2027/35



2027/30



8102/B0



5115



2027/25



7017/35
> 7017/42
7017/55



5115/B



5026/A



5026/B



5026/C



2027/35



2027/30



8094



8093



5057



8100/B0



2027/25



7022/33
> 7022/42
7022/46
7022/53



5057/B



5136



5137



5112/B0



8101/B0



5138



5139



5113/B0

linea Classic



	⊕⊗	↔	↑	↓	Material
5107/B0	-	27	-	158	Zamak
5107/FR	-	27	-	158	Zamak
5108/B0	-	21	-	124	Zamak
5108/FR	-	21	-	124	Zamak
5112/B0	-	28	-	154	Zamak
5113/B0	-	22	-	123	Zamak
5120	-	27	-	158	Zamak
5121	-	27	-	158	Zamak
5122	-	21	-	124	Zamak



5120



5121



5107/B0



5107/FR



5122



5123



5108/B0



5108/FR

	⊕⊗	↔	↑	↓	Material
5123	-	21	-	124	Zamak
5136	-	28	-	154	Zamak
5137	-	28	-	154	Zamak
5138	-	22	-	123	Zamak
5139	-	22	-	123	Zamak
8101/B0	-	19	-	82	Zamak

FINITURE / FINISHING

	E8		O3
	10		O4
	30		O1
	A8		D1

linea
Classic



5011/G



5011/A



5011/B



8122



8026

	⊕	↔	↑	↓	Material
5010/A	-	110	-	70	Zamak
5010/B	-	80	-	50	Zamak
5010/C	-	69	-	46	Zamak
5010/64	64	80	-	50	Zamak
5011/G	96	163	-	39	Zamak
5011/A	96	133	-	31	Zamak
5011/B	64	96	-	22	Zamak
8021	-	120	-	18	Zamak
8022	-	86	-	15	Zamak

	⊕	↔	↑	↓	Material
8026	-	60	-	29	Zamak
8122	-	28	-	60	Zamak



5010/A



5010/B



5010/C



5010/64



8021



8022

FINITURE / FINISHING

	E8		03
	10		04
	30		01
	A8		D1



7009/22
7009/33
> 7009/42
7009/46
7009/53



8025



6004/31



6004/28



6004/24



6004/18



8024

linea Classic



	⊕⊕	↔	↑	↓	Material
6004/18	-	18	17	-	Zamak
6004/24	-	24	22	-	Zamak
6004/28	-	28	25	-	Zamak
6004/31	-	31	27	-	Zamak
6009/16	-	18	16	16	Zamak
6009/21	-	23	21	21	Zamak
6009/26	-	29	24	26	Zamak
6009/30	-	33	25	30	Zamak
6009/36	-	39	28	36	Zamak



8019



8020



7009/22
7009/33
> 7009/42
7009/46
7009/53



6009/36



6009/30



6009/26



6009/21



6009/16



	⊕⊕	↔	↑	↓	Material
7009/22	6	31	-	61	Zamak
7009/33	6	31	-	72	Zamak
7009/42	6	31	-	81	Zamak
7009/46	6	31	-	85	Zamak
7009/53	6	31	-	92	Zamak
8019	-	14	-	130	Zamak
8020	-	14	-	90	Zamak
8024	-	93	-	24	Zamak
8025	-	22	-	85	Zamak

FINITURE / FINISHING

	E8		O3
	I10		O4
	S30		O1
	A8		D1

linea Classic



	⊕	↔	↑	↓	Material
2027/25	-	25	22	-	Brass-Zn
2027/30	-	30	24	-	Brass-Zn
2027/35	-	35	29	-	Brass-Zn
5014/A	-	60	-	-	Zamak
5014/B	-	51	-	-	Zamak
5014/C	-	39	-	-	Zamak
5017/A	-	47	-	-	Zamak
5017/B	-	37	-	-	Zamak
5017/G	-	55	-	-	Zamak



5017/G Ø 55



5017/A Ø 47



5017/B Ø 37



5017/P Ø 32



2027/35



8032



2027/30



7003/22
7003/33
> 7003/42
7003/46
7003/53



2027/25

	⊕	↔	↑	↓	Material
5017/P	-	32	-	-	Zamak
7002/33	6	32	-	66	Zamak
7002/42	6	32	-	75	Zamak
7003/22	6	22	-	54	Zamak
7003/33	6	22	-	65	Zamak
7003/42	6	22	-	74	Zamak
7003/46	6	22	-	78	Zamak
7003/53	6	22	-	85	Zamak
8032	-	30	-	-	Zamak



5014/A



5014/B



5014/C



2027/35



8086

	⊕	↔	↑	↓	Material
8086	-	40	-	-	Zamak



2027/30



7002/33
> 7002/42



2027/25

FINITURE / FINISHING

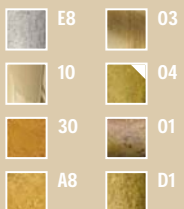



5248/A



5248/B



6102



2027/35



2027/30



2027/25



8012



7020/33
> 7020/42
7020/46
7020/53



8013



8033

linea Classic



	⊕	↔	↑	↓	Material
2027/25	-	25	22	-	Brass-Zn
2027/30	-	30	24	-	Brass-Zn
2027/35	-	35	29	-	Brass-Zn
5033/A	-	58	-	60	Zamak
5033/B	-	44	-	46	Zamak
5248/A	32	86	-	65	Zamak
5248/B	32	65	-	48	Zamak
6015/24	-	24	19	-	Zamak
6015/30	-	30	20	-	Zamak



5033/A



5033/B



6015/37



8084



6015/30



6015/24



7003/22
7003/33
> 7003/42
7003/46
7003/53



	⊕	↔	↑	↓	Material
6015/37	-	37	20	-	Zamak
6102	-	35	21	25	Zamak
7003/22	6	22	-	54	Zamak
7003/33	6	22	-	65	Zamak
7003/42	6	22	-	74	Zamak
7003/46	6	22	-	78	Zamak
7003/53	6	22	-	85	Zamak
7020/33	6	28	-	67	Zamak
7020/42	6	28	-	76	Zamak

	⊕	↔	↑	↓	Material
7020/46	6	28	-	80	Zamak
7020/53	6	28	-	87	Zamak
8012	-	20	-	130	Zamak
8013	-	120	-	31	Zamak
8033	-	25	-	36	Zamak
8084	-	33	-	43	Zamak

FINITURE / FINISHING

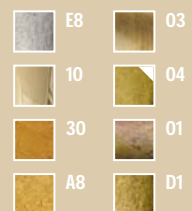



5038/A1



5038/A2 



5038/A3 



5038/A4



5038/A5 



5020/A1



5020/A2 







5020/B1



5020/B2 

linea
Classic



					Material
5020/A1	-	99	-	47	Zamak
5020/A2	-	99	-	47	Zamak
5020/B1	-	84	-	42	Zamak
5020/B2	-	84	-	42	Zamak
5038/A1	64	96	-	46	Zamak
5038/A2	64	96	-	46	Zamak
5038/A3	-	96	-	34	Zamak
5038/A4	-	33	-	101	Zamak
5038/A5	-	33	-	101	Zamak

FINITURE / FINISHING

	E8		O3
	24		O4
	30		O1
	A8		D1



5038/A6



5038/A7



5038/A8



7018/33
> 7018/42
7018/46
7018/53



5038/B6



5038/B3

linea Classic



					Material
5027	-	27	-	80	Zamak
5028	-	27	-	40	Zamak
5038/A6	-	34	-	96	Zamak
5038/A7	-	34	-	54	Zamak
5038/A8	-	34	-	35	Zamak
5038/B3	-	43	-	25	Zamak
5038/B6	-	25	-	43	Zamak
7005/22	6	30	-	53	Zamak
7005/33	6	30	-	64	Zamak



8049



7005/22
7005/33
> 7005/42
7005/46
7005/53



5027

					Material
7005/42	6	30	-	73	Zamak
7005/46	6	30	-	77	Zamak
7005/53	6	30	-	84	Zamak
7018/33	6	33	-	67	Zamak
7018/42	6	33	-	76	Zamak
7018/46	6	33	-	80	Zamak
7018/53	6	33	-	87	Zamak
8049	-	27	-	80	Zamak
8050/A3	-	37	-	100	Zamak



8050/A3



5028

					Material
8050/B3	-	33	-	85	Zamak
8067	-	29	-	29	Zamak



8050/B3



8067

FINITURE / FINISHING

	E8		O3
	24		O4
	30		O1
	A8		D1

linea Classic



5080/G
economic assembled



5080/A
economic assembled



5080/B
economic assembled



5080/M
economic assembled



5081/A
economic assembled



5080/C
economic assembled



5081/B
economic assembled



5081/C
economic assembled

	⊕	↔	↑	↓	Material
5022/A	-	62	-	50	Zamak
5022/B	-	44	-	35	Zamak
5075/A	-	85	-	60	Zamak
5075/B	-	57	-	43	Zamak
5075/KA	-	85	-	60	Zamak
5075/KB	-	57	-	43	Zamak
5076/A	-	62	-	58	Zamak
5076/B	-	44	-	42	Zamak
5080/A	-	60	-	55	Zamak

	⊕	↔	↑	↓	Material
5080/B	-	55	-	48	Zamak
5080/C	-	54	-	42	Zamak
5080/G	-	68	-	58	Zamak
5080/M	-	67	-	51	Zamak
5081/A	-	60	-	55	Zamak
5081/B	-	52	-	48	Zamak
5081/C	-	43	-	42	Zamak



5022/A



5022/B



5075/A
(5022/A + 8043)



5075/B
(5022/B + 8048)



5075/KA
economic
(5022/KA + 8043/PK)



5075/KB
economic
(5022/KB + 8048/PK)



5076/A
(5022/A + 0008/30)



5076/B
(5022/B + 0008/25)

FINITURE / FINISHING

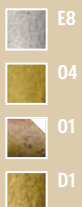



5199/GB
economic assembled



5199/GC
economic assembled



5199/B
economic assembled



5199/C
economic assembled



5200/B
assembled



5200/C
assembled



1022/KB



5025



1022/KC

linea Classic



	⊕	↔	↑	↓	Material
1022/KB	(40)	40	-	46	Zamak
1022/KC	(34)	34	-	39	Zamak
5025	(20)	20	-	22	Zamak
5199/B	(40)	55	-	52	Zamak
5199/C	(34)	55	-	49	Zamak
5199/GB	(40)	67	-	52	Zamak
5199/GC	(34)	67	-	45	Zamak
5200/B	(40)	40	-	50	Zamak
5200/C	(34)	34	-	43	Zamak



8039



8040



8041



8042

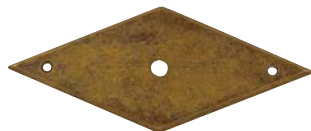

8043



8043/PK
economic



8044



8045



8046



8047



8048



8048/PK
economic

	⊕	↔	↑	↓	Material
8039	-	35	-	85	Zamak
8040	-	35	-	85	Zamak
8041	-	85	-	35	Zamak
8042	-	85	-	35	Zamak
8043	-	85	-	35	Zamak
8043/PK	-	85	-	35	Zamak
8044	-	28	-	55	Zamak
8045	-	28	-	55	Zamak
8046	-	55	-	28	Zamak

	⊕	↔	↑	↓	Material
8047	-	55	-	28	Zamak
8048	-	55	-	28	Zamak
8048/PK	-	55	-	28	Zamak

FINITURE / FINISHING

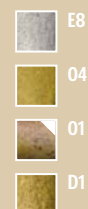

linea Classic



	⊕	↔	↑	↓	Material
1022/KB	(40)	40	-	45	Zamak
1022/KC	(34)	34	-	38	Zamak
1035/KB	48 (6)	48	-	52	Zamak
1035/KC	37 (5)	37	-	39	Zamak
1036/KA	46 (5)	46	-	49	Zamak
1036/KB	40 (4)	40	-	41	Zamak
1036/KC	35 (4)	35	-	36	Zamak
1036/KD	30 (4)	30	-	31	Zamak
5032/A	(40)	40	-	43	Zamak

	⊕	↔	↑	↓	Material
5032/B	34	34	-	38	Zamak
5190/A	-	81	-	58	Zamak
5190/B	-	65	-	50	Zamak
5190/C	-	65	-	44	Zamak
5195/B	(40)	40	-	43	Zamak
5195/C	(34)	34	-	37	Zamak
5201/A	(40)	81	-	53	Zamak
5201/B	(40)	65	-	51	Zamak
5201/C	(34)	65	-	45	Zamak

	⊕	↔	↑	↓	Material
5205/A	-	81	-	58	Zamak
5205/B	-	65	-	45	Zamak
5206/A	46 (5)	81	-	59	Zamak
5206/C	35 (4)	65	-	47	Zamak

FINITURE / FINISHING

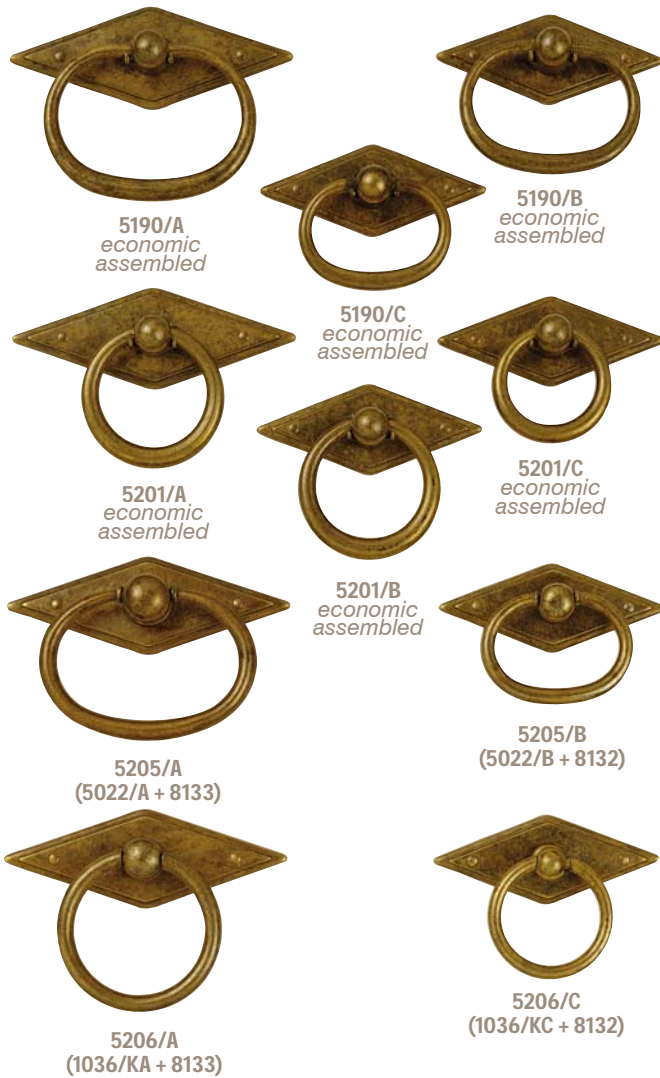
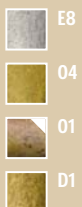



8131

7012/22
7012/33
> 7012/42
7012/46
7012/53



8135



8133



8130

7005/22
7005/33
> 7005/42
7005/46
7005/53



8134



8132



5208/A



5208/B



8133 + 2025/30



8132 + 2025/25

linea Classic



	⊕	↔	↑	↓	Material
5023	-	15	-	51	Zamak
5208/A	-	30	-	81	Zamak
5208/B	-	26	-	65	Zamak
5210/A	(40)	40	V	81	Zamak
5210/A	(40)	81	-	54	Zamak
5210/B	(40)	81	-	52	Zamak
5210/C	(34)	34	V	65	Zamak
5210/C	(34)	65	-	44	Zamak
7005/22	6	30	-	53	Zamak



5210/A
(5195/B + 8133)
vertical



8131



5023

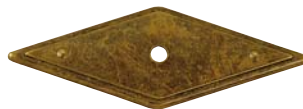

8133



5210/C
(5195/C + 8132)
vertical



8130

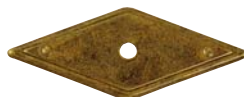

8132



5210/A (5195/B + 8133)



5210/B (5195/B + 8132)



5210/C
(5195/C + 8132)

	⊕	↔	↑	↓	Material
7005/33	6	30	-	64	Zamak
7005/42	6	30	-	73	Zamak
7005/46	6	30	-	77	Zamak
7005/53	6	30	-	84	Zamak
7012/22	6	30	-	60	Zamak
7012/33	6	30	-	71	Zamak
7012/42	6	30	-	80	Zamak
7012/46	6	30	-	84	Zamak
7012/53	6	30	-	91	Zamak

	⊕	↔	↑	↓	Material
8130	-	26	-	65	Zamak
8131	-	29	-	81	Zamak
8132	-	65	-	26	Zamak
8133	-	81	-	29	Zamak
8133+2025/30	30	81	28	30	Zamak
8132+2025/25	25	65	25	25	Zamak
8134	-	65	-	26	Zamak
8135	-	81	-	29	Zamak

FINITURE / FINISHING

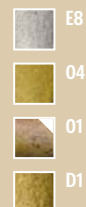

linea Classic



	⊕	↔	↑	↓	Material
1035/KB	48 (6)	48	-	52	Zamak
1035/KC	37 (5)	37	-	39	Zamak
1036/KA	46 (5)	46	-	49	Zamak
1036/KB	40 (4)	40	-	41	Zamak
1036/KC	35 (4)	35	-	36	Zamak
1036/KD	30 (4)	30	-	31	Zamak
5197/B	48 (6)	82	-	60	Zamak
5197/C	37 (5)	55	-	46	Zamak
5198/A	46 (5)	82	-	60	Zamak

	⊕	↔	↑	↓	Material
5198/B	40 (4)	55	-	52	Zamak
5198/C	35 (4)	55	-	48	Zamak
5198/D	30 (4)	55	-	42	Zamak
5202/B	48 (6)	48	-	56	Zamak
5202/C	37 (5)	37	-	45	Zamak
5203/A	46 (5)	46	-	57	Zamak
5203/B	40 (4)	40	-	48	Zamak
5203/C	35 (4)	35	-	45	Zamak
5203/D	30 (4)	30	-	40	Zamak



1035/KB
Ø 48 - (6)



1036/KA
Ø 46 - (5)



5203/A
(1036/KA + 0008/30)



1035/KC
Ø 37 - (5)



1036/KB
Ø 40 - (4)



5203/B
(1036/KB + 0008/25)



5202/B
(1035/KB + 0008/30)



1036/KC
Ø 35 - (4)



5203/C
(1036/KC + 0008/25)



5202/C
(1035/KC + 0008/25)



1036/KD
Ø 30 - (4)



5203/D
(1036/KD + 0008/25)



5197/B
(1035/KB + 8043)



5197/C
(1035/KB + 8048)



5198/A
(1036/KA + 8043)



5198/B
(1036/KB + 8048)



5198/C
(1036/KC + 8048)



5198/D
(1036/KD + 8048)

FINITURE / FINISHING

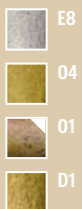



5007/A



5007/B



6002/31



5007/C



6002/28



6002/22

7010/22
7010/33
> 7010/42
7010/46
7010/53



8061



6002/18



5095



5096

linea Classic



	⊕	↔	↑	↓	Material
5007/A	-	128	-	41	Zamak
5007/B	-	109	-	36	Zamak
5007/C	-	94	-	82	Zamak
5095	-	33	-	40	Zamak
5096	-	33	-	43	Zamak
5197/KB	48(6)	82	-	60	Zamak
5197/KC	37(5)	55	-	46	Zamak
5198/KA	46(5)	82	-	60	Zamak
5198/KB	40(4)	55	-	52	Zamak



5197/KB
(1035/KB + 8043/PK)
economic



5197/KC
(1035/KC + 8048/PK)
economic



5198/KA
(1036/KA + 8043/PK)
economic



5198/KB
(1036/KB + 8048/PK)
economic



5198/KC
(1036/KC + 8048/PK)
economic



5198/KD
(1036/KD + 8048/PK)
economic

	⊕	↔	↑	↓	Material
5198/KC	35(4)	55	-	48	Zamak
5198/KD	30(4)	55	-	42	Zamak
6002/18	-	18	15	-	Zamak
6002/22	-	22	18	-	Zamak
6002/28	-	28	20	-	Zamak
6002/31	-	31	22	-	Zamak
7010/22	6	31	-	47	Zamak
7010/33	6	31	-	58	Zamak
7010/42	6	31	-	67	Zamak

	⊕	↔	↑	↓	Material
7010/46	6	31	-	71	Zamak
7010/53	6	31	-	78	Zamak
8061	-	28	-	35	Zamak

FINITURE / FINISHING

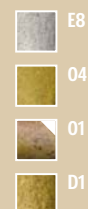

linea Classic



	⊕	↔	↑	↓	Material
1036/KB	(40)	40	-	41	Zamak
5000/A	-	133	-	58	Zamak
5000/B	-	108	-	48	Zamak
5000/C	-	90	-	38	Zamak
5036/A1	64	93	-	41	Zamak
5036/A7	32	63	-	23	Zamak
5036/B1	32	62	-	30	Zamak
5037	-	20	-	65	Zamak
5052/A1	64	93	-	43	Zamak



	⊕	↔	↑	↓	Material
5052/B1	32	62	-	29	Zamak
6000/24	-	24	20	-	Zamak
6000/30	-	30	21	-	Zamak
6000/37	-	37	22	-	Zamak
7005/22	6	30	-	53	Zamak
7005/33	6	30	-	64	Zamak
7005/42	6	30	-	73	Zamak
7005/46	6	30	-	77	Zamak
7005/53	6	30	-	84	Zamak

	⊕	↔	↑	↓	Material
8054	-	15	-	98	Zamak
8091/VE	-	25	-	85	Zamak
8091/OR	-	85	-	25	Zamak
8091/PL	-	85	-	25	Zamak

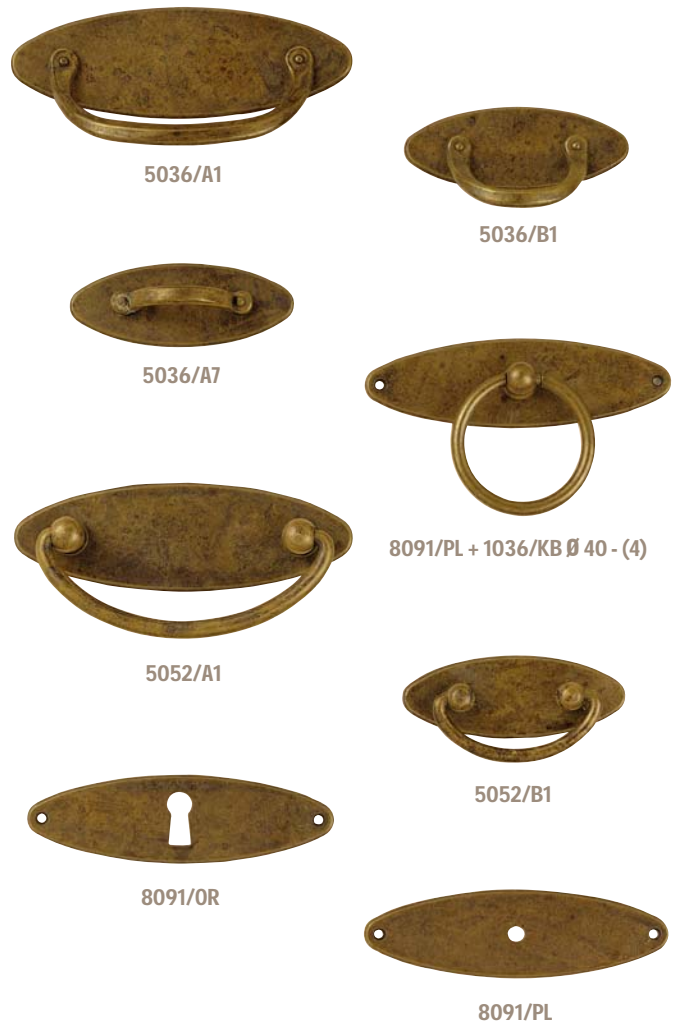

FINITURE / FINISHING

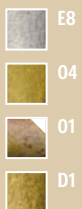



linea Classic



	⊕	↔	↑	↓	Material
5036/A4	32	25	-	85	Zamak
5036/A5	32	25	-	85	Zamak
5037	-	20	-	65	Zamak
5050/A	96	117	-	47	Zamak
5050/B	64	80	-	32	Zamak
6002/18	-	18	15	-	Zamak
6002/22	-	22	18	-	Zamak
6002/28	-	28	20	-	Zamak
6002/31	-	31	22	-	Zamak



	⊕	↔	↑	↓	Material
6008/24	-	24	20	-	Zamak
6008/31	-	31	27	-	Zamak
6008/37	-	37	29	-	Zamak
6016	-	36	19	27	Zamak
6018	-	27	17	20	Zamak
7005/22	6	30	-	53	Zamak
7005/33	6	30	-	64	Zamak
7005/42	6	30	-	73	Zamak
7005/46	6	30	-	77	Zamak

	⊕	↔	↑	↓	Material
7005/53	6	30	-	84	Zamak
7007/33	6	34	-	62	Zamak
7007/42	6	34	-	71	Zamak
7007/46	6	34	-	75	Zamak
7007/53	6	34	-	82	Zamak
8066	-	18	-	34	Zamak
8083/VE	-	20	-	36	Zamak
8083/OR	-	36	-	20	Zamak
8083/PL	-	36	-	20	Zamak

	⊕	↔	↑	↓	Material
8091/VE	-	25	-	85	Zamak
8091/OR	-	85	-	25	Zamak
8091/PL	-	85	-	25	Zamak

linea Classic



5035/A1



5035/B1



8092



8082



5035/A4



5035/A5



7006/22
7006/33
> 7006/42
7006/46
7006/53

	⊕	↔	↑	↓	Material
5003/A	-	96	-	45	Zamak
5003/B	-	73	-	34	Zamak
5035/A1	64	92	-	43	Zamak
5035/A4	32	24	-	82	Zamak
5035/A5	32	24	-	82	Zamak
5035/B1	32	66	-	33	Zamak
5037	-	20	-	65	Zamak
6000/24	-	24	20	-	Zamak
6000/30	-	30	21	-	Zamak

	⊕	↔	↑	↓	Material
6000/37	-	37	22	-	Zamak
7006/22	6	30	57	-	Zamak
7006/33	6	30	68	-	Zamak
7006/42	6	30	77	-	Zamak
7006/46	6	30	81	-	Zamak
7006/53	6	30	88	-	Zamak
7007/33	6	34	-	62	Zamak
7007/42	6	34	-	71	Zamak
7007/46	6	34	-	75	Zamak

	⊕	↔	↑	↓	Material
7007/53	6	34	-	82	Zamak
8062	-	19	-	46	Zamak
8082	-	25	-	41	Zamak
8092	-	75	-	31	Zamak



5003/A



5003/B



5037



8062



6000/37



6000/30



6000/24



7007/33
> 7007/42
7007/46
7007/53

FINITURE / FINISHING

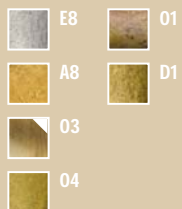



linea
Classic



	⊕	↔	↑	↓	Material
2024/25	-	25	21	-	Brass-Zn
2024/30	-	30	24	-	Brass-Zn
2024/35	-	35	27	-	Brass-Zn
5002/A	-	111	-	50	Zamak
5002/B	-	108	-	49	Zamak
5037	-	20	-	65	Zamak
5074/A	96	110	-	42	Zamak
5074/B	64	77	-	29	Zamak
6000/24	-	24	20	-	Zamak



	⊕	↔	↑	↓	Material
6000/30	-	30	21	-	Zamak
6000/37	-	37	22	-	Zamak
7012/22	6	30	-	60	Zamak
7012/33	6	30	-	71	Zamak
7012/42	6	30	-	80	Zamak
7012/46	6	30	-	84	Zamak
7012/53	6	30	-	91	Zamak
7014/22	6	24	-	55	Zamak
7014/33	6	24	-	66	Zamak

	⊕	↔	↑	↓	Material
7014/42	6	24	-	75	Zamak
7014/46	6	24	-	79	Zamak
7014/53	6	24	-	86	Zamak
8035	-	17	-	50	Zamak
8036	-	48	-	22	Zamak
8065	-	18	-	35	Zamak
8089	-	24	-	34	Zamak

FINITURE / FINISHING

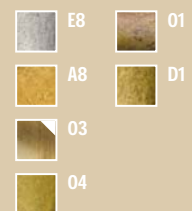

linea Classic



	⊕	↔	↑	↓	Material
2025/25	-	25	22	-	Brass-Zn
2025/30	-	30	25	-	Brass-Zn
2025/35	-	35	28	-	Brass-Zn
5001/A	-	121	-	53	Zamak
5001/B	-	101	-	47	Zamak
5049/A	96	115	-	48	Zamak
5049/B	64	79	-	35	Zamak
5060	-	20	-	67	Zamak
6001/24	-	24	22	-	Zamak



	⊕	↔	↑	↓	Material
6001/32	-	32	25	-	Zamak
6001/37	-	37	30	-	Zamak
7011/33	6	35	-	62	Zamak
7011/42	6	35	-	71	Zamak
7011/46	6	35	-	75	Zamak
7011/53	6	35	-	82	Zamak
7098/22	6	32	-	56	Zamak
7098/33	6	32	-	67	Zamak
7098/42	6	32	-	76	Zamak

	⊕	↔	↑	↓	Material
7098/46	6	32	-	80	Zamak
7098/53	6	32	-	87	Zamak
8037	-	20	-	37	Zamak
8038	-	18	-	36	Zamak
8063	-	21	-	62	Zamak



FINITURE / FINISHING





8098/PL



8098/PL + 2025/30



8098/OR



8011
8011/PK *economic*



8010



8098/VE



8008

linea Classic



	⊕	↔	↑	↓	Material
2025/30	-	30	25	-	Brass-Zn
5037	-	20	-	65	Zamak
5048/A	96	115	-	46	Zamak
5048/B	64	80	-	33	Zamak
6008/24	-	24	20	-	Zamak
6008/31	-	31	27	-	Zamak
6008/37	-	37	29	-	Zamak
6018	-	27	17	20	Zamak
7007/33	6	34	-	62	Zamak



5048/A



5048/B



5037



8096



oval



6018



7007/33
> 7007/42
7007/46
7007/53



6008/37



6008/31



6008/24



8088

	⊕	↔	↑	↓	Material
7007/42	6	34	-	71	Zamak
7007/46	6	34	-	75	Zamak
7007/53	6	34	-	82	Zamak
8008	-	16	-	90	Zamak
8010	-	87	-	20	Zamak
8011	-	16	-	87	Zamak
8011/PK	-	16	-	87	Zamak
8088	-	24	-	47	Zamak
8096	-	24	-	47	Zamak

	⊕	↔	↑	↓	Material
8098/VE	-	30	-	74	Zamak
8098/OR	-	74	-	30	Zamak
8098/PL	-	74	-	30	Zamak

FINITURE / FINISHING



linea Classic



	⊕	↔	↑	↓	Material
2024/25	-	25	21	-	Brass-Zn
2024/30	-	30	24	-	Brass-Zn
2024/35	-	35	27	-	Brass-Zn
2025/25	-	25	22	-	Brass-Zn
2025/30	-	30	25	-	Brass-Zn
2025/35	-	35	28	-	Brass-Zn
5037	-	20	-	65	Zamak
5043/A	96	118	-	47	Zamak
5043/B	64	83	-	36	Zamak

	⊕	↔	↑	↓	Material
5044/A	96	116	-	46	Zamak
5044/B	64	79	-	31	Zamak
5058	-	20	-	67	Zamak
6016	-	36	19	27	Zamak
7005/22	6	30	-	53	Zamak
7005/33	6	30	-	64	Zamak
7005/42	6	30	-	73	Zamak
7005/46	6	30	-	77	Zamak
7005/53	6	30	-	84	Zamak

	⊕	↔	↑	↓	Material
7012/22	6	30	-	60	Zamak
7012/33	6	30	-	71	Zamak
7012/42	6	30	-	80	Zamak
7012/46	6	30	-	84	Zamak
7012/53	6	30	-	91	Zamak
8037	-	20	-	37	Zamak
8065	-	18	-	34	Zamak
8089	-	24	-	34	Zamak

FINITURE / FINISHING



5044/A



5044/B



5037



6016 oval + base



8065



2024/35



2024/30



2024/25



7005/22
7005/33
> 7005/42
7005/46
7005/53



8089

Ø 19



5043/A



5058



8037



5043/B



2025/35



2025/30



2025/25



7012/22
7012/33
> 7012/42
7012/46
7012/53



8089

Ø 19



5051/A



5051/B



5037



8096



2025/35



2025/30



2025/25



7005/22
7005/33
> 7005/42
7005/46
7005/53



8088

Ø 19

linea Classic



	⊕⊕	↔	↑	↓	Material
2024/25	-	25	21	-	Brass-Zn
2024/30	-	30	24	-	Brass-Zn
2024/35	-	35	27	-	Brass-Zn
2025/25	-	25	22	-	Brass-Zn
2025/30	-	30	25	-	Brass-Zn
2025/35	-	35	28	-	Brass-Zn
5037	-	20	-	65	Zamak
5041/A	96	117	-	45	Zamak
5041/B	64	83	-	36	Zamak



5041/A



5041/B



5037



8065



2024/35



2024/30



2024/25



7005/22
7005/33
> 7005/42
7005/46
7005/53



8089

Ø 19

	⊕⊕	↔	↑	↓	Material
5051/A	96	117	-	45	Zamak
5051/B	64	80	-	33	Zamak
7005/22	6	30	-	53	Zamak
7005/33	6	30	-	64	Zamak
7005/42	6	30	-	73	Zamak
7005/46	6	30	-	77	Zamak
7005/53	6	30	-	84	Zamak
8065	-	18	-	35	Zamak
8088	-	24	-	47	Zamak

	⊕⊕	↔	↑	↓	Material
8089	-	24	-	34	Zamak
8096	-	24	-	47	Zamak

FINITURE / FINISHING

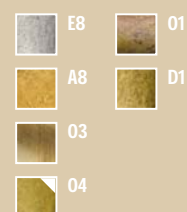

linea
Classic



5030



5094



5031/A



5031/B



5230/64



5600



X2D32



X3D48/8

	⌀	↔	↑	↓	Material
2031/25	-	25	24	-	Brass-Zn
2031/30	-	30	27	-	Brass-Zn
2031/35	-	35	31	-	Brass-Zn
5030	64	78	-	29	Zamak
5031/A	96	105	-	35	Zamak
5031/B	64	74	-	32	Zamak
5047/A	96	115	-	46	Zamak
5047/B	64	79	-	34	Zamak
5058	-	20	-	67	Zamak

	⌀	↔	↑	↓	Material
5094	32	80	-	52	Zamak
5230/64	64	85	-	22	Zamak
5600	-	42	-	56	Zamak
7098/22	6	32	-	56	Zamak
7098/33	6	32	-	67	Zamak
7098/42	6	32	-	76	Zamak
7098/46	6	32	-	80	Zamak
7098/53	6	32	-	87	Zamak
8008	-	17	-	88	Zamak

	⌀	↔	↑	↓	Material
X2D32	-	55	18	35	Zamak
X3D48/8	-	48	10	48	Zamak



5047/A



5047/B



2031/35



2031/30



2031/25



5058



8008



7098/22
7098/33
> 7098/42
7098/46
7098/53

FINITURE / FINISHING





5072/A



5072/B



5092



5091



5090



linea Classic



	⊕	↔	↑	↓	Material
5072/A	96	131	-	22	Zamak
5072/B	64	95	-	14	Zamak
5090	64	85	-	22	Zamak
5091	64	84	-	34	Zamak
5092	64	75	-	35	Zamak
8005	-	21	-	250	Zamak
8006/VE	-	21	-	187	Zamak
8006/OR	-	187	-	21	Zamak
8006/PL	-	187	-	21	Zamak



8010



8007



8009



8006/VE vertical
8006/OR horizontal
8006/PL plate



8005



8011

8011/PK economic

	⊕	↔	↑	↓	Material
8007	-	17	-	138	Zamak
8009	-	17	-	138	Zamak
8010	-	87	-	20	Zamak
8011	-	88	-	17	Zamak
8011/PK	-	88	-	17	Zamak

FINITURE / FINISHING

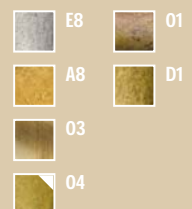

linea Classic



	⊕	↔	↑	↓	Material
5004/A	96	118	-	50	Zamak
5004/B	-	99	-	42	Zamak
5013	64	96	-	39	Zamak
5018/A	-	82	-	75	Zamak
5018/B	-	64	-	61	Zamak
5058	-	20	-	67	Zamak
6000/24	-	24	20	-	Zamak
6000/30	-	30	21	-	Zamak
6000/37	-	37	22	-	Zamak



	⊕	↔	↑	↓	Material
6009/16	-	18	16	16	Zamak
6009/21	-	23	21	21	Zamak
6009/26	-	29	24	26	Zamak
6009/30	-	33	25	30	Zamak
6009/36	-	39	28	36	Zamak
7011/33	6	35	-	62	Zamak
7011/42	6	35	-	71	Zamak
7011/46	6	35	-	75	Zamak
7011/53	6	35	-	82	Zamak



	⊕	↔	↑	↓	Material
7098/22	6	32	-	56	Zamak
7098/33	6	32	-	67	Zamak
7098/42	6	32	-	76	Zamak
7098/46	6	32	-	80	Zamak
7098/53	6	32	-	87	Zamak
8029	-	26	-	47	Zamak
8059	-	15	-	68	Zamak
8060	-	69	-	23	Zamak



FINITURE / FINISHING





5045/A



5060



8037



5045/B



2025/35



2025/30



2025/25



7012/22
7012/33
> 7012/42
7012/46
7012/53



8089

Ø19

linea Classic



	⊕⊕	↔	↑	↓	Material
2025/25	-	25	22	-	Brass-Zn
2025/30	-	30	25	-	Brass-Zn
2025/35	-	35	28	-	Brass-Zn
5005/A	-	93	-	62	Zamak
5005/B	-	76	-	61	Zamak
5006/A	-	86	-	56	Zamak
5006/B	-	69	-	44	Zamak
5045/A	96	116	-	49	Zamak
5045/B	64	79	-	32	Zamak



5005/A



5005/B



8008



7008/33
> 7008/42
7008/46
7008/53



8064



5006/A



5006/B

7006/22
7006/33
> 7006/42
7006/46
7006/53



	⊕⊕	↔	↑	↓	Material
5060	-	26	-	67	Zamak
7006/22	6	30	-	57	Zamak
7006/33	6	30	-	68	Zamak
7006/42	6	30	-	77	Zamak
7006/46	6	30	-	81	Zamak
7006/53	6	30	-	88	Zamak
7008/33	6	34	-	71	Zamak
7008/42	6	34	-	80	Zamak
7008/46	6	34	-	84	Zamak

	⊕⊕	↔	↑	↓	Material
7008/53	6	34	-	91	Zamak
7012/22	6	30	-	60	Zamak
7012/33	6	30	-	71	Zamak
7012/42	6	30	-	80	Zamak
7012/46	6	30	-	84	Zamak
7012/53	6	30	-	91	Zamak
8008	-	17	-	88	Zamak
8037	-	20	-	37	Zamak
8064	-	28	-	44	Zamak

	⊕⊕	↔	↑	↓	Material
8089	-	24	-	34	Zamak

linea Classic



	⊕	↔	↑	↓	Material
2025/25	-	25	22	-	Brass-Zn
2025/30	-	30	25	-	Brass-Zn
2025/35	-	35	28	-	Brass-Zn
5037	-	20	-	65	Zamak
5046/A	96	116	-	48	Zamak
5046/B	64	79	-	32	Zamak
5059	-	20	-	66	Zamak
5077/A	96	115	-	42	Zamak
5077/B	64	80	-	28	Zamak



	⊕	↔	↑	↓	Material
6002/18	-	18	15	-	Zamak
6002/22	-	22	18	-	Zamak
6002/28	-	28	20	-	Zamak
6002/31	-	31	22	-	Zamak
6017/A	-	36	24	23	Zamak
6017/B	-	30	22	20	Zamak
7007/33	6	34	-	62	Zamak
7007/42	6	34	-	71	Zamak
7007/46	6	34	-	75	Zamak



	⊕	↔	↑	↓	Material
7007/53	6	34	-	82	Zamak
7024/33	6	36	-	65	Zamak
7024/42	6	36	-	74	Zamak
7024/46	6	36	-	78	Zamak
7024/53	6	36	-	85	Zamak
8037	-	20	-	37	Zamak
8065	-	18	-	35	Zamak
8089	-	24	-	34	Zamak



FINITURE / FINISHING

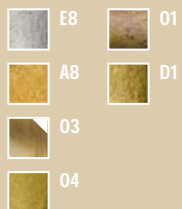



5079/A



5060



8037



5079/B



2025/35



2025/30



2025/25



7007/33
> 7007/42
7007/46
7007/53



8089



Ø 19

linea Classic



	⊕ ⊕	↔	↑	↓	Material
2025/25	-	25	22	-	Brass-Zn
2025/30	-	30	25	-	Brass-Zn
2025/35	-	35	28	-	Brass-Zn
5042/A	96	117	-	47	Zamak
5042/B	64	83	-	38	Zamak
5059	-	20	-	66	Zamak
5060	-	20	-	67	Zamak
5079/A	96	112	-	43	Zamak
5079/B	64	75	-	29	Zamak



5042/A



5059



8037



5042/B



2025/35



2025/30



2025/25



7024/33
> 7024/42
7024/46
7024/53



8089



Ø 19

	⊕ ⊕	↔	↑	↓	Material
7007/33	6	34	-	62	Zamak
7007/42	6	34	-	71	Zamak
7007/46	6	34	-	75	Zamak
7007/53	6	34	-	82	Zamak
7024/33	6	36	-	65	Zamak
7024/42	6	36	-	74	Zamak
7024/46	6	36	-	78	Zamak
7024/53	6	36	-	85	Zamak
8037	-	20	-	37	Zamak

	⊕ ⊕	↔	↑	↓	Material
8089	-	24	-	34	Zamak

FINITURE / FINISHING

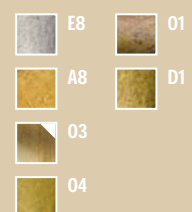

linea Classic



5012/A



5012/B



6004/31



6004/28



6004/24



6004/18



8023



7009/22
7009/33
> 7009/42
7009/46
7009/53

	⊕	↔	↑	↓	Material
5009/A	-	100	-	113	Zamak
5009/B	-	79	-	90	Zamak
5012/A	-	137	-	35	Zamak
5012/B	-	96	-	25	Zamak
6004/18	-	18	17	-	Zamak
6004/24	-	24	22	-	Zamak
6004/28	-	28	25	-	Zamak
6004/31	-	31	27	-	Zamak
6007/24	-	28	22	24	Zamak

	⊕	↔	↑	↓	Material
6007/28	-	32	24	28	Zamak
6007/34	-	38	26	34	Zamak
7006/22	6	30	-	57	Zamak
7006/33	6	30	-	68	Zamak
7006/42	6	30	-	77	Zamak
7006/46	6	30	-	81	Zamak
7006/53	6	30	-	88	Zamak
7009/22	6	31	-	61	Zamak
7009/33	6	31	-	72	Zamak

	⊕	↔	↑	↓	Material
7009/42	6	31	-	81	Zamak
7009/46	6	31	-	85	Zamak
7009/53	6	31	-	92	Zamak
8023	-	14	-	70	Zamak
8027	-	34	-	56	Zamak



5009/A



5009/B



8027

7006/22
7006/33
> 7006/42
7006/46
7006/53



FINITURE / FINISHING

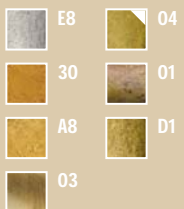

6007/34



6007/28



6007/24





5019/A



5019/B



8030



7015/22
7015/33
> 7015/42
7015/46
7015/53



6003/39



6003/31



6003/27



6003/25



6003/17



linea Classic



	⊕	↔	↑	↓	Material
2025/25	-	25	22	-	Brass-Zn
2025/30	-	30	25	-	Brass-Zn
2025/35	-	35	28	-	Brass-Zn
5019/A	-	65	-	79	Zamak
5019/B	-	50	-	63	Zamak
5054/A	96	113	-	48	Zamak
5054/B	64	82	-	33	Zamak
5059	-	20	-	66	Zamak
6003/17	-	17	14	-	Zamak



5054/A



5054/B



2025/35



2025/30



2025/25



7024/33
> 7024/42
7024/46
7024/53



5059



8037

	⊕	↔	↑	↓	Material
6003/25	-	25	18	-	Zamak
6003/27	-	27	20	-	Zamak
6003/31	-	31	22	-	Zamak
6003/39	-	39	23	-	Zamak
7015/22	6	29	-	52	Zamak
7015/33	6	29	-	63	Zamak
7015/42	6	29	-	72	Zamak
7015/46	6	29	-	76	Zamak
7015/53	6	29	-	83	Zamak

	⊕	↔	↑	↓	Material
7024/33	6	36	-	65	Zamak
7024/42	6	36	-	74	Zamak
7024/46	6	36	-	78	Zamak
7024/53	6	36	-	85	Zamak
8030	-	21	-	38	Zamak
8037	-	20	-	37	Zamak

FINITURE / FINISHING



linea Classic



2000/35

2002/35



2000/30

2002/30



2000/25

2002/25



2000/20

2002/20

	⊕	↔	↑	↓	Material
2000/20	-	20	19	-	Brass
2000/25	-	25	22	-	Brass
2000/30	-	30	28	-	Brass
2000/35	-	35	31	-	Brass
2002/20	-	20	20	-	Brass
2002/25	-	25	22	-	Brass
2002/30	-	30	26	-	Brass
2002/35	-	35	28	-	Brass
2018/20	-	20	15	-	Brass

	⊕	↔	↑	↓	Material
2018/25	-	25	18	-	Brass
2018/30	-	30	22	-	Brass
2018/35	-	35	27	-	Brass



2018/35



2018/30



2018/25



2018/20

FINITURE / FINISHING

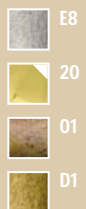



2016/35

2017/38



2016/28

2017/30

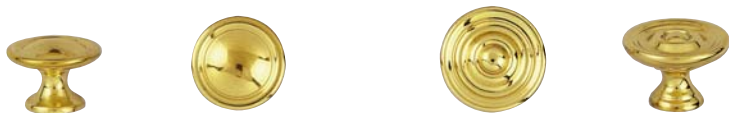

2016/22

2017/24



2019/35



2019/30



2019/25



2019/20

linea Classic



	⊕⊕	↔	↑	↓	Material
2016/22	-	22	16	-	Brass
2016/28	-	28	19	-	Brass
2016/35	-	35	21	-	Brass
2017/24	-	24	17	-	Brass
2017/30	-	30	19	-	Brass
2017/38	-	38	24	-	Brass
2019/20	-	20	17	-	Brass
2019/25	-	25	21	-	Brass
2019/30	-	30	26	-	Brass

	⊕⊕	↔	↑	↓	Material
2019/35	-	35	30	-	Brass

FINITURE / FINISHING

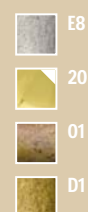



2027/35



2030/35

linea
Classic



2027/30



2030/30

	⊕	↔	↑	↓	Material
2027/25	-	25	22	-	Brass-Zn
2027/30	-	30	24	-	Brass-Zn
2027/35	-	35	29	-	Brass-Zn
2030/25	-	25	19	-	Brass-Zn
2030/30	-	30	21	-	Brass-Zn
2030/35	-	35	24	-	Brass-Zn
6010/17	-	17	14	-	Zamak
6010/24	-	24	17	-	Zamak
6010/29	-	29	21	-	Zamak



2027/25



2030/25

	⊕	↔	↑	↓	Material
6010/34	-	34	22	-	Zamak
6014/20	-	20	14	-	Zamak
6015/24	-	24	19	-	Zamak
6015/30	-	30	20	-	Zamak
6015/37	-	37	20	-	Zamak



6015/37



6010/34



6015/30



6010/29



6015/24



6010/24



6014/20



6010/17

FINITURE / FINISHING

	E8		03
	10		04
	30		01
	A8		D1



2026/35



2028/35



2026/30



2028/30



2026/25



2028/25

linea Classic



	⊕⊗	↔	↑	↓	Material
2026/25	-	25	24	-	Brass-Zn
2026/30	-	30	27	-	Brass-Zn
2026/35	-	35	31	-	Brass-Zn
2028/25	-	25	22	-	Brass-Zn
2028/30	-	30	25	-	Brass-Zn
2028/35	-	35	28	-	Brass-Zn
6004/18	-	18	17	-	Zamak
6004/24	-	24	22	-	Zamak
6004/28	-	28	25	-	Zamak



6004/31



6009/36



6004/28



6009/30



6004/24



6009/26



6004/18



6009/21



6009/16



	⊕⊗	↔	↑	↓	Material
6004/31	-	31	27	-	Zamak
6009/16	-	18	16	16	Zamak
6009/21	-	23	21	21	Zamak
6009/26	-	29	24	26	Zamak
6009/30	-	33	25	30	Zamak
6009/36	-	39	28	36	Zamak

FINITURE / FINISHING

	E8		O3
	I0		O4
	S30		O1
	AB		D1

linea Classic



6000/37



6002/31



6000/30



6002/28



6000/24



6002/22



6000/KB
economic



6002/18



6000/KC
economic

	⊕	↔	↑	↓	Material
6000/24	-	24	20	-	Zamak
6000/30	-	30	21	-	Zamak
6000/37	-	37	22	-	Zamak
6000/KC	-	24	20	-	Zamak
6000/KB	-	30	21	-	Zamak
6002/18	-	18	15	-	Zamak
6002/22	-	22	18	-	Zamak
6002/28	-	28	20	-	Zamak
6002/31	-	31	22	-	Zamak

	⊕	↔	↑	↓	Material
6006/16	-	16	14	-	Zamak
6006/25	-	25	19	-	Zamak
6006/31	-	31	21	-	Zamak
6006/35	-	35	23	-	Zamak
6022/25	-	25	20	-	Zamak
6022/30	-	30	20	-	Zamak



6006/35



6006/31



6022/30



6006/25



6022/25



6006/16

FINITURE / FINISHING

	E8		O3
	O6		O4
	30		O1
	A8		D1



6008/37



6017/A



6008/31



6017/B



6008/24



6016 Oval + base



7095/P0



6018

linea
Classic



	⊕⊕	↔	↑	↓	Material
6008/24	-	24	20	-	Zamak
6008/31	-	31	27	-	Zamak
6008/37	-	37	29	-	Zamak
6011/18	-	18	16	-	Zamak
6011/25	-	25	19	-	Zamak
6011/31	-	31	23	-	Zamak
6011/42	-	42	27	-	Zamak
6016	-	36	19	27	Zamak
6017/A	-	36	24	23	Zamak



6011/42



6011/31



6011/25



6011/18



	⊕⊕	↔	↑	↓	Material
6017/B	-	30	22	20	Zamak
6018	-	27	17	20	Zamak
7095/P0	-	44	34	15	Zamak

FINITURE / FINISHING





2031/35

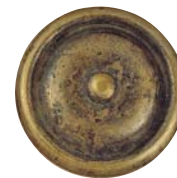

2022/35



linea Classic



2031/30

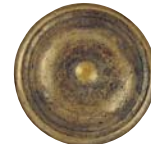

2022/30



2031/25



2022/25



	⊕ ⊖	↔	↑	↓	Material
2022/25	-	25	20	-	Brass-Zn
2022/30	-	30	23	-	Brass-Zn
2022/35	-	35	27	-	Brass-Zn
2023/25	-	25	21	-	Brass-Zn
2023/30	-	30	25	-	Brass-Zn
2023/35	-	35	27	-	Brass-Zn
2031/25	-	25	24	-	Brass-Zn
2031/30	-	30	27	-	Brass-Zn
2031/35	-	35	31	-	Brass-Zn



2023/35



2023/30



2023/25



FINITURE / FINISHING





2025/35



2032/35



2025/30



2032/30



2025/25



2032/25



2024/35



2024/30



2024/25



2007/30



linea
Classic



	⊕⊕	↔	↑	↓	Material
2007/30	-	30	32	20	Zamak
2024/25	-	25	21	-	Brass-Zn
2024/30	-	30	24	-	Brass-Zn
2024/35	-	35	27	-	Brass-Zn
2025/25	-	25	22	-	Brass-Zn
2025/30	-	30	25	-	Brass-Zn
2025/35	-	35	28	-	Brass-Zn
2032/25	-	25	18	-	Brass-Zn
2032/30	-	30	22	-	Brass-Zn

	⊕⊕	↔	↑	↓	Material
2032/35	-	35	24	-	Brass-Zn

FINITURE / FINISHING

E8	03
10	04
30	01
A8	D1

linea Classic



6003/39

6001/37



6003/31

6001/32



6003/27

6001/24



6003/25

6102

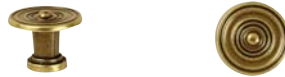

6003/17

	⊕	↔	↑	↓	Material
0092	-	45	-	-	Brass
0093	-	40	-	-	Brass
2050/45	-	45	24	-	Brass
2050/60	-	60	29	-	Brass
2051/60	-	60	26	-	Brass
6001/24	-	24	22	-	Zamak
6001/32	-	32	25	-	Zamak
6001/37	-	37	30	-	Zamak
6003/17	-	17	14	-	Zamak

	⊕	↔	↑	↓	Material
6003/25	-	25	18	-	Zamak
6003/27	-	27	20	-	Zamak
6003/31	-	31	22	-	Zamak
6003/39	-	39	23	-	Zamak
6102	-	35	21	25	Zamak



2050/60

2050/45

2051/60



2050/60

2050/45

2051/60



0092

0093

0092

FINITURE / FINISHING





6007/34



6005/30
economic

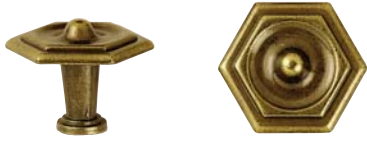

6007/28



6005/27
economic



6007/24



6005/19
economic



0524



6012/28

Finishing Code 07



0523

linea Classic



	⊕	↔	↑	↓	Material
0093	-	40	-	-	Brass
0523	-	76	-	25	Iron
0524	-	25	-	76	Iron
2029/25	-	25	19	-	Brass-Zn
2029/30	-	30	21	-	Brass-Zn
2029/35	-	35	24	-	Brass-Zn
2029/45	-	45	25	-	Brass
2051/45	-	45	22	-	Brass
6005/19	-	19	15	-	Zamak



2051/45



2029/35



2029/45



2051/45



2029/30



2029/45



0093



2029/25



0093

	⊕	↔	↑	↓	Material
6005/27	-	27	19	-	Zamak
6005/30	-	30	21	-	Zamak
6007/24	-	28	22	24	Zamak
6007/28	-	32	24	28	Zamak
6007/34	-	38	26	34	Zamak
6012/28	-	28	22	-	Zamak

FINITURE / FINISHING



linea Classic



	⊕	↔	↑	↓	Material
7005/22	6	30	-	53	Zamak
7005/33	6	30	-	64	Zamak
7005/42	6	30	-	73	Zamak
7005/46	6	30	-	77	Zamak
7005/53	6	30	-	84	Zamak
7005/TC	-	30	34	-	Zamak
7007/33	6	34	-	62	Zamak
7007/42	6	34	-	71	Zamak
7007/46	6	34	-	75	Zamak



7005/22

7005/33

7005/42



7005/46

7005/53

	⊕	↔	↑	↓	Material
7007/53	6	34	-	82	Zamak
7007/TC	-	34	32	-	Zamak
7009/TC	-	31	42	-	Zamak
7011/33	6	35	-	62	Zamak
7011/42	6	35	-	71	Zamak
7011/46	6	35	-	75	Zamak
7011/53	6	35	-	82	Zamak
7012/22	6	30	-	60	Zamak
7012/33	6	30	-	71	Zamak



7012/22
7012/33
> 7012/42
7012/46
7012/53

7007/33
> 7007/42
7007/46
7007/53

7011/33
> 7011/42
7011/46
7011/53

	⊕	↔	↑	↓	Material
7012/42	6	30	-	80	Zamak
7012/46	6	30	-	84	Zamak
7012/53	6	30	-	91	Zamak
7098/TC	-	32	38	-	Zamak
7112/46	6	34	-	59	Zamak



7112/46

7098/TC

7007/TC

7009/TC

7005/TC

FINITURE / FINISHING

	E8		O3
	I0		O4
	S0		O1
	A8		D1



7001/53 Ø 7



7016/35
> 7016/42
7016/55



7010/22
7010/33
> 7010/42
7010/46
7010/53



7015/22
7015/33
> 7015/42
7015/46
7015/53



7000/54 Ø 8

linea Classic

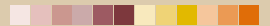

	⊕ ⊕	↔	↑	↓	Material
603/42	6	35	-	67	Zamak
603/53	6	35	-	78	Zamak
7000/54	8	29	-	88	Zamak
7001/53	7	28	-	83	Zamak
7010/22	6	31	-	47	Zamak
7010/33	6	31	-	58	Zamak
7010/42	6	31	-	67	Zamak
7010/46	6	31	-	71	Zamak
7010/53	6	31	-	78	Zamak



7014/22
7014/33
> 7014/42
7014/46
7014/53



7013/22
7013/33
> 7013/42
7013/46
7013/53



> WCH603/42
WCH603/53



7098/22
7098/33
> 7098/42
7098/46
7098/53



7021/35
> 7021/42
7021/55

	⊕ ⊕	↔	↑	↓	Material
7013/22	6	20	-	56	Zamak
7013/33	6	20	-	67	Zamak
7013/42	6	20	-	76	Zamak
7013/46	6	20	-	80	Zamak
7013/53	6	20	-	87	Zamak
7014/22	6	24	-	55	Zamak
7014/33	6	24	-	66	Zamak
7014/42	6	24	-	75	Zamak
7014/46	6	24	-	79	Zamak

	⊕ ⊕	↔	↑	↓	Material
7014/53	6	24	-	86	Zamak
7015/22	6	29	-	52	Zamak
7015/33	6	29	-	63	Zamak
7015/42	6	29	-	72	Zamak
7015/46	6	29	-	76	Zamak
7015/53	6	29	-	83	Zamak
7016/35	6	35	-	59	Zamak
7016/42	6	35	-	66	Zamak
7016/55	6	35	-	79	Zamak

	⊕ ⊕	↔	↑	↓	Material
7021/35	6	28	-	65	Zamak
7021/42	6	28	-	72	Zamak
7021/55	6	28	-	85	Zamak
7098/22	6	32	-	56	Zamak
7098/33	6	32	-	67	Zamak
7098/42	6	32	-	76	Zamak
7098/46	6	32	-	80	Zamak
7098/53	6	32	-	87	Zamak

linea Classic



7018/33
> 7018/42
7018/46
7018/53



7020/33
> 7020/42
7020/46
7020/53



7003/22
7003/33
> 7003/42
7003/46
7003/53



7097/22
> 7097/33
7097/42
7097/46
7097/53



7004/22
7004/33
> 7004/42
7004/46
7004/53

	⊕	↔	↑	↓	Material
7003/22	6	22	-	54	Zamak
7003/33	6	22	-	65	Zamak
7003/42	6	22	-	74	Zamak
7003/46	6	22	-	78	Zamak
7003/53	6	22	-	85	Zamak
7004/22	6	22	-	59	Zamak
7004/33	6	22	-	70	Zamak
7004/42	6	22	-	79	Zamak
7004/46	6	22	-	83	Zamak

	⊕	↔	↑	↓	Material
7004/53	6	22	-	90	Zamak
7017/35	6	34	-	77	Zamak
7017/42	6	34	-	84	Zamak
7017/55	6	34	-	97	Zamak
7018/33	6	33	-	67	Zamak
7018/42	6	33	-	76	Zamak
7018/46	6	33	-	80	Zamak
7018/53	6	33	-	87	Zamak
7020/33	6	28	-	67	Zamak

	⊕	↔	↑	↓	Material
7020/42	6	28	-	76	Zamak
7020/46	6	28	-	80	Zamak
7020/53	6	28	-	87	Zamak
7022/33	6	37	-	65	Zamak
7022/42	6	37	-	74	Zamak
7022/46	6	37	-	78	Zamak
7022/53	6	37	-	85	Zamak
7097/22	6	25	-	58	Zamak
7097/33	6	25	-	69	Zamak

	⊕	↔	↑	↓	Material
7097/42	6	25	-	78	Zamak
7097/46	6	25	-	82	Zamak
7097/53	6	25	-	89	Zamak
7200/42	6	25	-	70	Zamak
7200/53	6	25	-	81	Zamak
7201/42	6	35	-	72	Zamak
7201/53	6	35	-	83	Zamak



7017/35
> 7017/42
7017/55



> 7200/42
7200/53



7022/33
> 7022/42
7022/46
7022/53



> 7201/42
7201/53



7006/22
7006/33
> 7006/42
7006/46
7006/53



7024/33
> 7024/42
7024/46
7024/53



7023/35
> 7023/42
7023/55



7095/33



7095/P0

linea Classic



	⊕ ⊕	↔	↑	↓	Material
7002/33	6	32	-	66	Zamak
7002/42	6	32	-	75	Zamak
7006/22	6	30	-	57	Zamak
7006/33	6	30	-	68	Zamak
7006/42	6	30	-	77	Zamak
7006/46	6	30	-	81	Zamak
7006/53	6	30	-	88	Zamak
7008/33	6	34	-	71	Zamak
7008/42	6	34	-	80	Zamak



7009/22
7009/33
> 7009/42
7009/46
7009/53



7008/33
7008/42
> 7008/46
7008/53

	⊕ ⊕	↔	↑	↓	Material
7008/46	6	34	-	84	Zamak
7008/53	6	34	-	91	Zamak
7009/22	6	31	-	61	Zamak
7009/33	6	31	-	72	Zamak
7009/42	6	31	-	81	Zamak
7009/46	6	31	-	85	Zamak
7009/53	6	31	-	92	Zamak
7023/35	6	32	-	65	Zamak
7023/42	6	32	-	72	Zamak



7002/33
> 7002/42



7115/42

	⊕ ⊕	↔	↑	↓	Material
7023/55	6	32	-	85	Zamak
7024/33	6	36	-	65	Zamak
7024/42	6	36	-	74	Zamak
7024/46	6	36	-	78	Zamak
7024/53	6	36	-	85	Zamak
7095/33	6	44	-	67	Zamak
7095/P0	-	44	34	15	Zamak
7115/42	6	36	-	75	Zamak

FINITURE / FINISHING

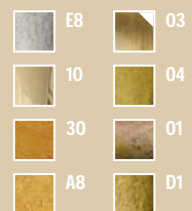

linea Classic



8051

8052

8053

8054

8055



8061

8062

8096

8059

8056

8060

8057

	⊕	↔	↑	↓	Material
5038/A3	-	96	-	34	Zamak
5038/A6	-	34	-	96	Zamak
5038/A8	-	34	-	35	Zamak
5038/B3	-	40	-	24	Zamak
5038/B6	-	24	-	40	Zamak
8049	-	27	-	80	Zamak
8050/A3	-	37	-	100	Zamak
8050/B3	-	33	-	85	Zamak
8051	-	27	-	108	Zamak

	⊕	↔	↑	↓	Material
8052	-	24	-	96	Zamak
8053	-	21	-	86	Zamak
8054	-	15	-	98	Zamak
8055	-	15	-	98	Zamak
8056	-	21	-	90	Zamak
8057	-	91	-	22	Zamak
8059	-	15	-	68	Zamak
8060	-	69	-	23	Zamak
8061	-	28	-	35	Zamak

	⊕	↔	↑	↓	Material
8062	-	19	-	46	Zamak
8067	-	29	-	29	Zamak
8096	-	24	-	47	Zamak



5038/A3

5038/A6

5038/A8

5038/B3

5038/B6



8050/A3

8049

8050/B3

8067

FINITURE / FINISHING





8028



8027



8029



8030



8035



8036



8063



8064



8037



8037/SP



8065



8038



8066

linea Classic



	⊕	↔	↑	↓	Material
8027	-	34	-	56	Zamak
8028	-	32	-	40	Zamak
8029	-	26	-	47	Zamak
8030	-	21	-	38	Zamak
8035	-	17	-	50	Zamak
8036	-	48	-	22	Zamak
8037	-	20	-	37	Zamak
8037/SP	-	20	-	44	Zamak
8038	-	18	-	36	Zamak



8039



8040

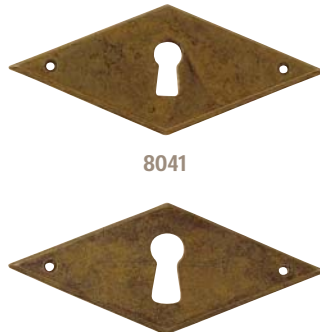

8041



8042



8131



8130

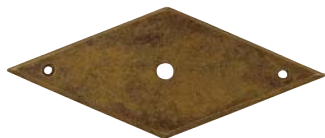

8043



8043/PK economic



8135



8044



8045



8046



8133



8047



8134



8048

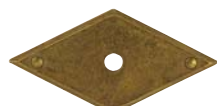

8048/PK economic



8132

	⊕	↔	↑	↓	Material
8039	-	35	-	85	Zamak
8040	-	35	-	85	Zamak
8041	-	85	-	35	Zamak
8042	-	85	-	35	Zamak
8043	-	85	-	35	Zamak
8043/PK	-	85	-	35	Zamak
8044	-	28	-	55	Zamak
8045	-	28	-	55	Zamak
8046	-	55	-	28	Zamak

	⊕	↔	↑	↓	Material
8047	-	55	-	28	Zamak
8048	-	55	-	28	Zamak
8048/PK	-	55	-	28	Zamak
8063	-	21	-	62	Zamak
8064	-	28	-	44	Zamak
8065	-	18	-	35	Zamak
8066	-	18	-	34	Zamak
8130	-	26	-	65	Zamak
8131	-	29	-	81	Zamak

	⊕	↔	↑	↓	Material
8132	-	65	-	26	Zamak
8133	-	81	-	29	Zamak
8134	-	65	-	26	Zamak
8135	-	81	-	29	Zamak

linea Classic



	⌀	↔	↑	↓	Material
8000	-	30	-	198	Zamak
8001	-	16	-	116	Zamak
8002/DX	-	20	-	175	Zamak
8002/SX	-	20	-	175	Zamak
8003/DX	-	20	-	175	Zamak
8003/SX	-	20	-	175	Zamak
8004/DX	-	15	-	133	Zamak
8004/SX	-	15	-	133	Zamak
8014/DX	-	16	-	157	Zamak



8000



8002/DX right
> 8002/SX left



8003/DX right
> 8003/SX left



8004/DX right
> 8004/SX left

	⌀	↔	↑	↓	Material
8014/SX	-	16	-	157	Zamak
8015/DX	-	16	-	157	Zamak
8015/SX	-	16	-	157	Zamak
8016/DX	-	14	-	90	Zamak
8016/SX	-	14	-	90	Zamak
8085	-	19	-	157	Zamak



8001



8085



8014/DX right
> 8014/SX left



8015/DX right
> 8015/SX left



8016/DX right
> 8016/SX left

FINITURE / FINISHING





> 8068 vertical
8069 vertical
8070 horizontal
8071 horizontal
8072 plate



> 8073 vertical
8074 vertical
8075 horizontal
8076 horizontal
8077 plate



> 8078
8079



8080 plate



0008/30 plate



0008/25 plate

linea Classic



					Material
0008/30	-	30	-	-	Zamak
0008/25	-	25	-	-	Zamak
8017	-	16	-	142	Zamak
8018	-	16	-	142	Zamak
8058	-	18	-	118	Zamak
8068	-	30	-	256	Zamak
8069	-	30	-	256	Zamak
8070	-	256	-	30	Zamak
8071	-	256	-	30	Zamak



8017



8018



8095



8058

					Material
8072	-	256	-	30	Zamak
8073	-	30	-	160	Zamak
8074	-	30	-	160	Zamak
8075	-	160	-	30	Zamak
8076	-	160	-	30	Zamak
8077	-	160	-	30	Zamak
8078	-	30	-	-	Zamak
8079	-	30	-	-	Zamak
8080	-	30	-	-	Zamak

					Material
8095	-	15	-	117	Zamak

FINITURE / FINISHING

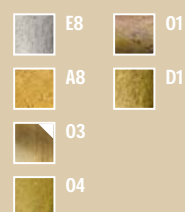

linea Classic



	⊕	↔	↑	↓	Material
8012	-	20	-	130	Zamak
8013	-	120	-	21	Zamak
8019	-	14	-	130	Zamak
8020	-	14	-	90	Zamak
8021	-	120	-	18	Zamak
8022	-	86	-	15	Zamak
8023	-	14	-	70	Zamak
8024	-	93	-	24	Zamak
8025	-	22	-	85	Zamak



	⊕	↔	↑	↓	Material
8026	-	60	-	29	Zamak
8031	-	31	-	39	Zamak
8087	-	36	-	35	Zamak
8122	-	28	-	60	Zamak
8203	-	26	-	150	Zamak



FINITURE / FINISHING

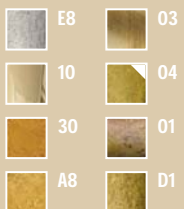



8010

8008

8009

8007

8011

8011/PK *economic*

8006/VE *vertical*
8006/OR *horizontal*
8006/PL *plate*

8005

linea Classic



	⊕ ⊖	↔	↑	↓	Material
8005	-	21	-	250	Zamak
8006/VE	-	21	-	187	Zamak
8006/OR	-	187	-	21	Zamak
8006/PL	-	187	-	21	Zamak
8007	-	17	-	138	Zamak
8008	-	17	-	88	Zamak
8009	-	17	-	138	Zamak
8011	-	88	-	17	Zamak
8011/PK	-	88	-	17	Zamak



WBC518

8180

WBC627

8200

8033

8034

WBC188

8201

8032

8090
8090/CP *heavy version*

Ø 19

WBC603

	⊕ ⊖	↔	↑	↓	Material
8032	-	30	-	-	Zamak
8033	-	25	-	36	Zamak
8034	-	36	-	26	Zamak
8090	-	25	-	36	Zamak
8180	-	25	-	60	Zamak
8200	-	25	-	55	Zamak
8201	-	24	-	37	Zamak
WBC188	-	21	-	41	Zamak
WBC603	-	25	-	49	Zamak

	⊕ ⊖	↔	↑	↓	Material
WBC518	-	24	-	58	Zamak
WBC627	-	26	-	84	Zamak

FINITURE / FINISHING

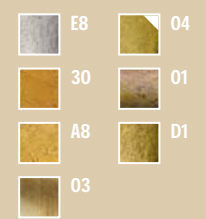

linea Classic



5112/B0

5113/B0

8101/B0

8100/B0

5108/B0

5107/B0



8094



8093



8098/VE



8098/OR



8098/PL



8102/B0



8105/B0

	⌀	↔	↑	↓	Material
5107/B0	-	27	-	158	Zamak
5108/B0	-	21	-	124	Zamak
5112/B0	-	28	-	154	Zamak
5113/B0	-	22	-	123	Zamak
8093	-	23	-	31	Zamak
8094	-	32	-	25	Zamak
8098/VE	-	30	-	74	Zamak
8098/OR	-	74	-	30	Zamak
8098/PL	-	74	-	30	Zamak

	⌀	↔	↑	↓	Material
8100/B0	-	19	-	86	Zamak
8101/B0	-	19	-	82	Zamak
8102/B0	-	25	-	39	Zamak
8105/B0	-	37	-	37	Zamak
8110	-	28	-	204	Zamak
8111	-	28	-	204	Zamak
8116	-	28	-	204	Zamak
8117	-	28	-	204	Zamak



8110



8111



8116



8117

FINITURE / FINISHING

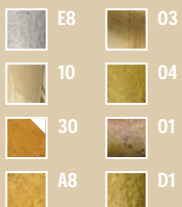

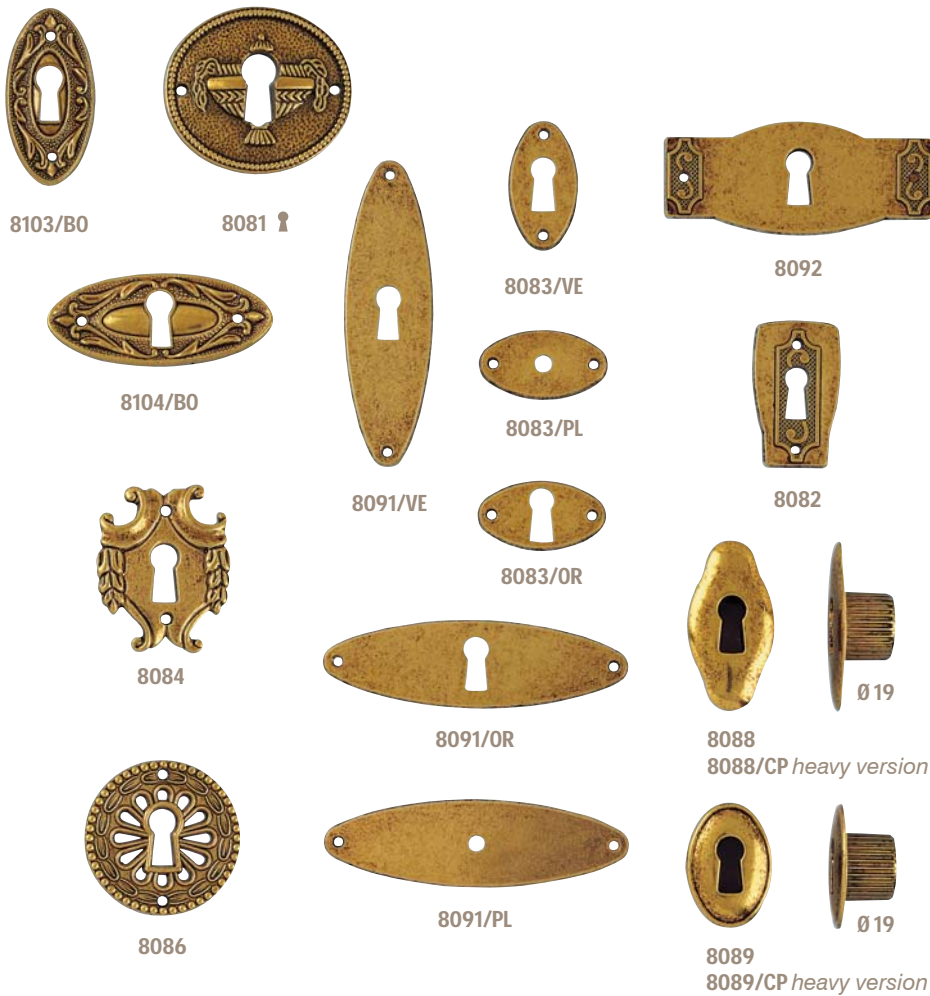

8103/B0

8081

8083/VE

8092

8104/B0

8091/VE

8083/PL

8082

8084

8083/OR

Ø 19

8091/OR

8088

8088/CP heavy version

8086

8091/PL

Ø 19

8089

8089/CP heavy version

linea Classic



	⊕ ⊗	↔	↑	↓	Material
8081	-	49	-	43	Zamak
8084	-	33	-	43	Zamak
8086	-	40	-	-	Zamak
8082	-	75	-	31	Zamak
8083/VE	-	20	-	36	Zamak
8083/OR	-	36	-	20	Zamak
8083/PL	-	36	-	20	Zamak
8088	-	24	-	47	Zamak
8089	-	24	-	34	Zamak



8114

8115

8120

8121

8112

8113

8118

8119



	⊕ ⊗	↔	↑	↓	Material
8091/VE	-	25	-	85	Zamak
8091/OR	-	85	-	25	Zamak
8091/PL	-	85	-	25	Zamak
8092	-	75	-	31	Zamak
8103/B0	-	23	-	45	Zamak
8104/B0	-	58	-	24	Zamak
8112	-	23	-	161	Zamak
8113	-	23	-	161	Zamak
8114	-	21	-	128	Zamak

	⊕ ⊗	↔	↑	↓	Material
8115	-	21	-	128	Zamak
8118	-	23	-	161	Zamak
8119	-	23	-	161	Zamak
8120	-	21	-	128	Zamak
8121	-	21	-	128	Zamak

FINITURE / FINISHING





	OTTONE PRESSOFUSO BRASS DIE-CAST	> PAGE 250		LAMIERINO DI OTTONE - PLASTICA BRASS FOIL - PLASTIC	> PAGE 290
	OTTONE FUSO IN TERRA BRASS SAND-CAST	> PAGE 274		FERRO IRON	> PAGE 292
	LAMIERINO DI OTTONE BRASS FOIL	> PAGE 276		VARIE MISCELLANEOUS	> PAGE 298



Classic
Old Style

linea
Classic
Old Style

OTTONE PRESSOFUSO
BRASS DIE-CAST



1021/A



1021/B



1018/A



1018/B



1037 Ø 39

	⌀	↔	↑	↓	Material
1018/A	96	118	-	54	Brass
1018/B	-	98	-	42	Brass
1021/A	-	125	-	49	Brass
1021/B	-	93	-	33	Brass
1035/A	(55)	55	-	58	Brass
1035/B	(48)	48	-	52	Brass
1035/C	(37)	37	-	39	Brass
1036/A	(46)	46	-	49	Brass
1036/B	(40)	40	-	41	Brass

	⌀	↔	↑	↓	Material
1036/C	(35)	35	-	36	Brass
1036/D	(30)	30	-	31	Brass
1036/E	(22)	22	-	23	Brass
1037	(39)	39	-	50	Brass
1041	(22)	22	-	26	Brass
1042	(23)	23	-	30	Brass



1035/A
Ø 55 - (6)



1035/B
Ø 48 - (6)



1035/C
Ø 37 - (5)



1036/A
Ø 46 - (5)



1036/C
Ø 35 - Ø 4



1036/D
Ø 30 - (4)



1036/B
Ø 40 - (4)



1036/E
Ø 22 - (3)



1042 Ø 23



1041 Ø 22

FINITURE / FINISHING

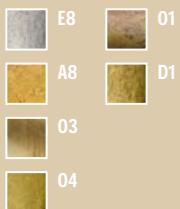



1022/A Ø 50



1022/B Ø 40



1022/C Ø 34



1022/D Ø 23

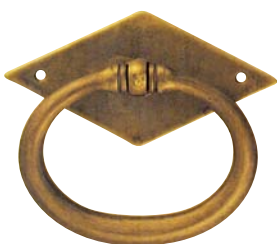

1023/A



1023/B



1024/A



1024/B

linea Classic Old Style

OTTONE PRESSOFUSO
BRASS DIE-CAST



	⊕	↔	↑	↓	Material
1015/A	-	90	-	63	Brass
1015/B	-	90	-	49	Brass
1016/A	-	90	-	61	Brass
1016/B	-	90	-	51	Brass
1017	-	90	-	48	Brass
1022/A	(50)	50	-	57	Brass
1022/B	(40)	40	-	45	Brass
1022/C	(34)	34	-	38	Brass
1022/D	(23)	23	-	28	Brass



1015/A



1015/B



1016/A



1016/B



1017



4097/PL



4097/OR



4097/VE

	⊕	↔	↑	↓	Material
1023/A	-	71	-	60	Brass
1023/B	-	56	-	43	Brass
1024/A	-	61	-	53	Brass
1024/B	-	43	-	43	Brass
1025/A	G	61	-	53	Brass
1025/B	G	43	-	40	Brass
1026/A	C	61	-	48	Brass
1026/B	C	43	-	35	Brass
4097/VE	-	38	-	90	Brass

	⊕	↔	↑	↓	Material
4097/OR	-	90	-	38	Brass
4097/PL	-	90	-	38	Brass

FINITURE / FINISHING

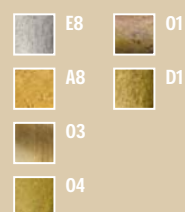

linea
Classic
Old Style

OTTONE PRESSOFUSO
BRASS DIE-CAST



1075



1074



1029



1028



1051



1039



1040

> 1027/A
1027/B

	⊕	↔	↑	↓	Material
1027/A	-	81	-	27	Brass
1027/B	-	66	-	25	Brass
1028	-	71	-	35	Brass
1029	-	31	-	45	Brass
1039	-	72	-	30	Brass
1040	-	65	-	33	Brass
1043/A	-	70	-	-	Brass
1043/B	-	50	-	-	Brass
1043/C	-	40	-	-	Brass

	⊕	↔	↑	↓	Material
1046/A	-	57	-	-	Brass
1046/B	-	46	-	-	Brass
1051	-	98	-	45	Brass
1074	-	32	-	40	Brass
1075	-	32	-	44	Brass



1043/A



1043/B



1043/C



1046/A



1046/B

FINITURE / FINISHING

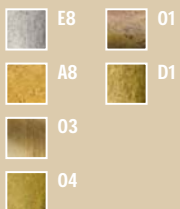



1030/A



1030/B

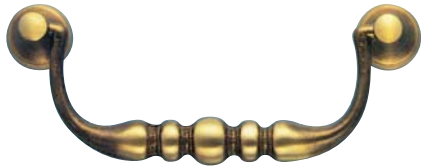

1030/C

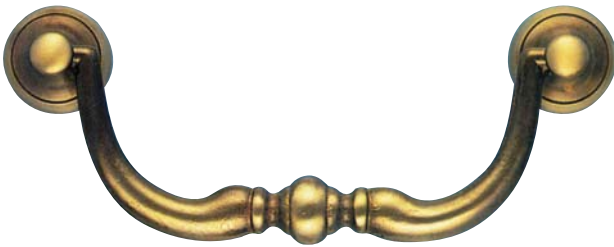

1031/A



1031/B

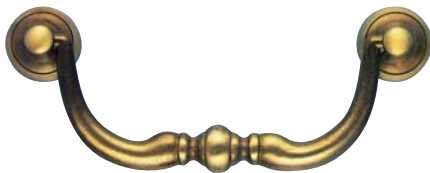

1031/C



1044/A



1044/B



1044/C

linea
Classic
Old Style

OTTONE PRESSOFUSO
BRASS DIE-CAST



	⊕	↔	↑	↓	Material
1030/A	-	126	-	51	Brass
1030/B	-	112	-	42	Brass
1030/C	-	100	-	36	Brass
1031/A	-	150	-	60	Brass
1031/B	-	130	-	46	Brass
1031/C	-	97	-	31	Brass
1044/A	-	52	-	-	Brass
1044/B	-	40	-	-	Brass
1044/C	-	35	-	-	Brass

FINITURE / FINISHING

	E8		O1
	A8		D1
	O3		
	O4		

linea
Classic
Old Style

OTTONE PRESSOFUSO
BRASS DIE-CAST



	⊕	↔	↑	↓	Material
1020/A	-	61	-	85	Brass
1020/B	-	41	-	59	Brass
1056/A	-	120	-	85	Brass
1056/B	-	80	-	50	Brass
1058/A	-	151	-	53	Brass
1058/B	-	118	-	40	Brass
1073	-	105	-	45	Brass



1056/A



1056/B



1058/A



1058/B



1020/A



1020/B



1073

FINITURE / FINISHING

	E8		O4
	30		O1
	A8		D1
	O3		

linea
Classic
Old Style

OTTONE PRESSOFUSO
BRASS DIE-CAST



	⊕⊗	↔	↑	↓	Material
1063/A	-	142	-	40	Brass
1063/B	-	114	-	37	Brass
1064/A	-	142	-	40	Brass
1064/B	-	114	-	37	Brass
1066/A	-	31	-	76	Brass
1066/B	-	25	-	64	Brass
1070	-	27	-	66	Brass
1076	-	64	-	49	Brass
1077	-	55	-	-	Brass



1066/A



1066/B



1070



1077



1076

FINITURE / FINISHING

	E8		O3
	I0		O4
	S30		O1
	A8		D1

linea
Classic
Old Style

OTTONE PRESSOFUSO
BRASS DIE-CAST



2000/35



2002/35



2000/30



2002/30



2000/25



2002/25

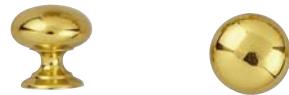

2000/20



2002/20

	⊕	↔	↑	↓	Material
2000/20	-	20	19	-	Brass
2000/25	-	25	22	-	Brass
2000/30	-	30	28	-	Brass
2000/35	-	35	31	-	Brass
2002/20	-	20	20	-	Brass
2002/25	-	25	22	-	Brass
2002/30	-	30	26	-	Brass
2002/35	-	35	28	-	Brass
2018/20	-	20	15	-	Brass

	⊕	↔	↑	↓	Material
2018/25	-	25	18	-	Brass
2018/30	-	30	22	-	Brass
2018/35	-	35	27	-	Brass
2019/20	-	20	17	-	Brass
2019/25	-	25	21	-	Brass
2019/30	-	30	26	-	Brass
2019/35	-	35	30	-	Brass



2018/35



2019/35



2018/30



2019/30



2018/25



2019/25



2018/20



2019/20

FINITURE / FINISHING

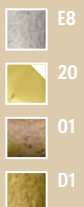



2016/35

2017/38



2016/28

2017/30



2016/22

2017/24

linea
Classic
Old Style

OTTONE PRESSOFUSO
BRASS DIE-CAST



	⊕	↔	↑	↓	Material
2004/21	-	21	16	-	Brass
2004/25	-	25	20	-	Brass
2004/31	-	31	22	-	Brass
2005/25	-	25	18	-	Brass
2005/30	-	30	20	-	Brass
2005/32	-	32	22	-	Brass
2005/38	-	38	24	-	Brass
2015/25	-	25	19	-	Brass
2015/30	-	30	21	-	Brass



2005/38



2004/31



2015/36



2005/32



2004/25



2015/30



2005/30



2004/21



2015/25



2005/25

	⊕	↔	↑	↓	Material
2015/36	-	36	23	-	Brass
2016/22	-	22	16	-	Brass
2016/28	-	28	19	-	Brass
2016/35	-	35	21	-	Brass
2017/24	-	24	17	-	Brass
2017/30	-	30	19	-	Brass
2017/38	-	38	24	-	Brass

FINITURE / FINISHING

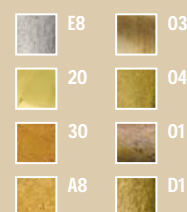



2031/35



2022/35

linea
Classic
Old Style

OTTONE PRESSOFUSO
BRASS DIE-CAST



2031/30



2022/30

	⊕	↔	↑	↓	Material
2001/25	-	25	20	-	Brass
2001/32	-	32	23	-	Brass
2003/23	-	23	17	-	Brass
2003/30	-	30	24	-	Brass
2003/42	-	42	29	-	Brass
2003/48	-	48	28	-	Brass
2007/30	-	30	32	20	Brass
2022/25	-	25	20	-	Brass-Zn
2022/30	-	30	23	-	Brass-Zn



2031/25



2022/25

	⊕	↔	↑	↓	Material
2022/35	-	35	27	-	Brass-Zn
2031/25	-	25	24	-	Brass-Zn
2031/30	-	30	27	-	Brass-Zn
2031/35	-	35	31	-	Brass-Zn



2003/48



2001/32



2003/42



2001/25



2003/30



2007/30



2003/23



FINITURE / FINISHING





2025/35



2032/35



2025/30



2032/30



2025/25



2032/25



2024/35



2032/35



2024/30



2032/30



2024/25



2032/25

linea
Classic
Old Style

OTTONE PRESSOFUSO
BRASS DIE-CAST



	⊕	↔	↑	↓	Material
2023/25	-	25	21	-	Brass-Zn
2023/30	-	30	25	-	Brass-Zn
2023/35	-	35	27	-	Brass-Zn
2024/25	-	25	21	-	Brass-Zn
2024/30	-	30	24	-	Brass-Zn
2024/35	-	35	27	-	Brass-Zn
2025/25	-	25	22	-	Brass-Zn
2025/30	-	30	25	-	Brass-Zn
2025/35	-	35	28	-	Brass-Zn

	⊕	↔	↑	↓	Material
2032/25	-	25	18	-	Brass-Zn
2032/30	-	30	22	-	Brass-Zn
2032/35	-	35	24	-	Brass-Zn

FINITURE / FINISHING

	E8		O3
	10		O4
	30		O1
	A8		D1

linea
Classic
Old Style

OTTONE PRESSOFUSO
BRASS DIE-CAST



2027/35

2030/35



2027/30

2030/30



2027/25

2030/25

	⊕	↔	↑	↓	Material
0092	-	45	-	-	Brass
0093	-	40	-	-	Brass
2027/25	-	25	22	-	Brass-Zn
2027/30	-	30	24	-	Brass-Zn
2027/35	-	35	29	-	Brass-Zn
2030/25	-	25	19	-	Brass-Zn
2030/30	-	30	21	-	Brass-Zn
2030/35	-	35	24	-	Brass-Zn
2050/45	-	45	24	-	Brass

	⊕	↔	↑	↓	Material
2050/60	-	60	29	-	Brass
2051/60	-	60	26	-	Brass



2050/60

2050/45

2051/60



2050/60

2050/45

2051/60



0092

0093

0092

FINITURE / FINISHING

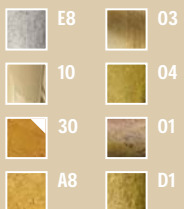



2026/35



2028/35



2026/30



2028/30



2026/25



2028/25

linea
Classic
Old Style

OTTONE PRESSOFUSO
BRASS DIE-CAST



	⊕	↔	↑	↓	Material
0093	-	40	-	-	Brass
2026/25	-	25	24	-	Brass-Zn
2026/30	-	30	27	-	Brass-Zn
2026/35	-	35	31	-	Brass-Zn
2028/25	-	25	22	-	Brass-Zn
2028/30	-	30	25	-	Brass-Zn
2028/35	-	35	28	-	Brass-Zn
2029/25	-	25	19	-	Brass-Zn
2029/30	-	30	21	-	Brass-Zn

	⊕	↔	↑	↓	Material
2029/35	-	35	24	-	Brass-Zn
2029/45	-	45	25	-	Brass
2051/45	-	45	22	-	Brass



2051/45



2029/35



2029/45



2051/45



2029/30



2029/45



0093



2029/25



0093

FINITURE / FINISHING

	E8		O3
	I0		O4
	S0		O1
	A8		D1

linea
Classic
Old Style

OTTONE PRESSOFUSO
BRASS DIE-CAST



	⊕	↔	↑	↓	Material
2006/13	-	13	15	-	Brass
2006/17	-	17	15	-	Brass
2006/20	-	20	19	-	Brass
2006/24	-	24	20	-	Brass
2006/26	-	26	20	-	Brass
2006/30	-	30	22	-	Brass
2006/32	-	32	26	-	Brass
2006/34	-	34	26	-	Brass
2006/40	-	40	29	-	Brass

	⊕	↔	↑	↓	Material
2008/10	3MA	10	-	-	Brass
2008/12	3MA	12	-	-	Brass
2008/15	3MA	15	-	-	Brass
2011/14	-	14	13	-	Brass
2011/16	-	16	13	-	Brass
2011/18	-	18	14	-	Brass
2011/20	-	20	16	-	Brass
2011/22	-	22	18	-	Brass
2011/28	-	28	20	-	Brass



2006/40



2006/26

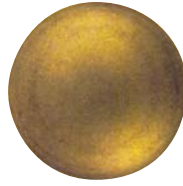

2006/34

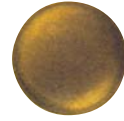

2006/24



2006/32



2006/20



2006/30



2006/17



2006/13



2011/28



2011/22



2011/20



2011/18



2011/16



2011/14



2008/15 3MA



2008/12 3MA



2008/10 3MA

FINITURE / FINISHING





> 2012/38
2012/35



2012/32



2012/30

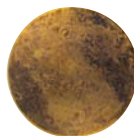

2012/28

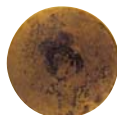

2012/24



2012/20



2012/22



> 2012/18
2012/16
2012/13
2012/10



2009/45



2010/45
2010/39
> 2010/35



2009/37



2010/30



2009/32



2010/24



2009/24



2010/16



2009/17

linea Classic Old Style

OTTONE PRESSOFUSO
BRASS DIE-CAST



	⊕	↔	↑	↓	Material
2009/17	-	17	17	-	Brass
2009/24	-	24	23	-	Brass
2009/32	-	32	26	-	Brass
2009/37	-	37	30	-	Brass
2009/45	-	45	31	-	Brass
2010/16	-	16	15	-	Brass
2010/24	-	24	24	-	Brass
2010/30	-	30	26	-	Brass
2010/35	-	35	28	-	Brass

	⊕	↔	↑	↓	Material
2010/39	-	39	33	-	Brass
2010/45	-	45	37	-	Brass
2012/10	-	10	10	-	Brass
2012/13	-	13	11	-	Brass
2012/16	-	16	13	-	Brass
2012/18	-	18	13	-	Brass
2012/20	-	20	15	-	Brass
2012/22	-	22	16	-	Brass
2012/24	-	24	17	-	Brass

	⊕	↔	↑	↓	Material
2012/28	-	28	20	-	Brass
2012/30	-	30	20	-	Brass
2012/32	-	32	22	-	Brass
2012/35	-	35	23	-	Brass
2012/38	-	38	24	-	Brass

FINITURE / FINISHING



linea
Classic
Old Style

OTTONE PRESSOFUSO
BRASS DIE-CAST



	⌀	↔	↑	↓	Material
3000/42	7,5	40	-	78	Brass
3000/54	7,5	40	-	88	Brass
3001/42	7,5	28	-	75	Brass
3001/54	7,5	28	-	87	Brass
3002/42	7,5	27	-	72	Brass
3002/54	7,5	27	-	84	Brass
3003/42	7,5	38	-	80	Brass
3003/54	7,5	38	-	91	Brass
3007/40	7	28	-	69	Brass

	⌀	↔	↑	↓	Material
3007/53	7	28	-	82	Brass
3008/40	7	31	-	69	Brass
3008/53	7	31	-	82	Brass
3009/40	7	34	-	71	Brass
3009/53	7	34	-	84	Brass



> 3000/42 Ø 7,5
3000/54 Ø 7,5



> 3001/42 Ø 7,5
3001/54 Ø 7,5



3002/42 Ø 7,5
> 3002/54 Ø 7,5



> 3003/42 Ø 7,5
3003/54 Ø 7,5



3007/40 Ø 7



3007/53 Ø 7



> 3008/40 Ø 7
3008/53 Ø 7



> 3009/40 Ø 7
3009/53 Ø 7

FINITURE / FINISHING

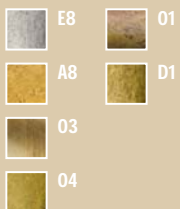



3004/40 Ø 7



3004/53 Ø 7



> 3005/40 Ø 7
> 3005/53 Ø 7



3006/40 Ø 7
> 3006/53 Ø 7

linea Classic Old Style

OTTONE PRESSOFUSO
BRASS DIE-CAST



	⊕	↔	↑	↓	Material
3004/40	7	30	-	70	Brass
3004/53	7	30	-	83	Brass
3005/40	7	34	-	68	Brass
3005/53	7	34	-	81	Brass
3006/40	7	38	-	70	Brass
3006/53	7	38	-	83	Brass
3010/22	6	30	-	51	Brass
3010/32	6	30	-	62	Brass
3010/42	6	30	-	71	Brass



3010/22



3010/32



3010/42



3010/45



3010/52

	⊕	↔	↑	↓	Material
3010/45	6	30	-	75	Brass
3010/52	6	30	-	82	Brass

FINITURE / FINISHING

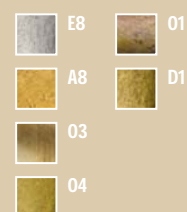

linea
Classic
Old Style

OTTONE PRESSOFUSO
BRASS DIE-CAST



	⊕	↔	↑	↓	Material
3011/22	6	35	-	53	Brass
3011/32	6	35	-	63	Brass
3011/42	6	35	-	73	Brass
3011/45	6	35	-	76	Brass
3011/52	6	35	-	83	Brass
3012/22	6	33	-	50	Brass
3012/32	6	33	-	60	Brass
3012/42	6	33	-	70	Brass
3012/45	6	33	-	73	Brass

	⊕	↔	↑	↓	Material
3012/42	6	33	-	80	Brass
3013/22	6	25	-	51	Brass
3013/32	6	25	-	61	Brass
3013/42	6	25	-	71	Brass
3013/45	6	25	-	74	Brass
3013/52	6	25	-	81	Brass
3014/32	6	38	-	62	Brass
3014/42	6	38	-	72	Brass
3014/45	6	38	-	75	Brass

	⊕	↔	↑	↓	Material
3014/52	6	38	-	82	Brass
3019/22	6	24	-	54	Brass
3019/32	6	24	-	64	Brass
3019/42	6	24	-	74	Brass
3019/45	6	24	-	77	Brass
3019/52	6	24	-	84	Brass
3020/22	6	29	-	60	Brass
3020/32	6	29	-	70	Brass
3020/42	6	29	-	80	Brass

	⊕	↔	↑	↓	Material
3020/45	6	29	-	83	Brass
3020/52	6	29	-	90	Brass



3011/22
3011/32
> 3011/42
3011/45
3011/52



3012/22
3012/32
> 3012/42
3012/45
3012/52



3014/32
> 3014/42
3014/45
3014/52



3013/22
3013/32
> 3013/42
3013/45
3013/52



3019/22



3019/32



> 3019/42
3019/45



3019/52



3020/22
> 3020/32



> 3020/42
3020/45



3020/52



3015/22
3015/32
> 3015/42
3015/45
3015/52



3016/22
3016/32
3016/42
3016/45
> 3016/52



3017/22
3017/32
> 3017/42
3017/45
3017/52



3018/22
3018/32
> 3018/42
3018/45
3018/52

linea
Classic
Old Style

OTTONE PRESSOFUSO
BRASS DIE-CAST



	⊕	↔	↑	↓	Material
3013/BP	6	25	-	72	Brass
3015/22	6	31	-	52	Brass
3015/32	6	31	-	62	Brass
3015/42	6	31	-	72	Brass
3015/45	6	31	-	75	Brass
3015/52	6	31	-	82	Brass
3016/22	6	28	-	52	Brass
3016/32	6	28	-	62	Brass
3016/42	6	28	-	72	Brass



3013/BP



3016/BP

	⊕	↔	↑	↓	Material
3016/45	6	28	-	75	Brass
3016/52	6	28	-	82	Brass
3016/BP	6	28	-	72	Brass
3017/22	6	32	-	48	Brass
3017/32	6	32	-	58	Brass
3017/42	6	32	-	68	Brass
3017/45	6	32	-	71	Brass
3017/52	6	32	-	78	Brass
3018/22	6	29	-	46	Brass

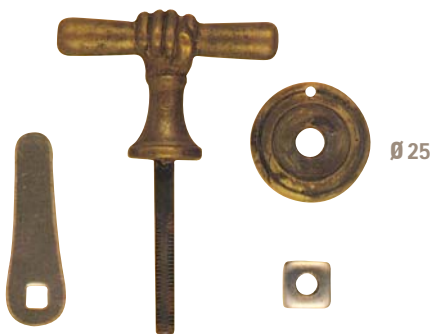

3021/A

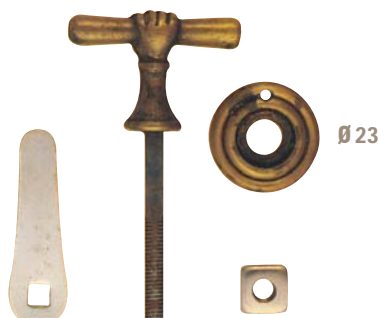

3021/B

	⊕	↔	↑	↓	Material
3018/32	6	29	-	56	Brass
3018/42	6	29	-	66	Brass
3018/45	6	29	-	69	Brass
3018/52	6	29	-	76	Brass
3021/A	-	46	-	32	Brass
3021/B	-	36	-	26	Brass

FINITURE / FINISHING

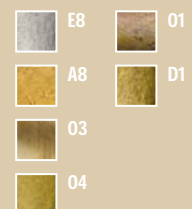

linea
Classic
Old Style

OTTONE PRESSOFUSO
BRASS DIE-CAST



	⊕	↔	↑	↓	Material
4000	-	30	-	263	Brass
4001	-	16	-	217	Brass
4002	-	13	-	200	Brass
4029	-	29	-	58	Brass
4030	-	34	-	51	Brass
4032	-	21	-	75	Brass
4033	-	27	-	71	Brass
4034	-	27	-	46	Brass
4035	-	45	-	50	Brass



4000



4001



4002

	⊕	↔	↑	↓	Material
4036	-	24	-	37	Brass
4037	-	30	-	67	Brass



4029



4030



4032



4033



4034



4035



4036



4037

FINITURE / FINISHING



01



4038



4039



4041



4042



4043



4046



4047



4044



4045

linea Classic Old Style

OTTONE PRESSOFUSO
BRASS DIE-CAST



	⊕	↔	↑	↓	Material
4009	-	45	-	67	Brass
4010	-	27	-	58	Brass
4011	-	20	-	42	Brass
4012	-	25	-	36	Brass
4013	-	26	-	41	Brass
4014	-	30	-	44	Brass
4019	-	50	-	35	Brass
4020	-	45	-	65	Brass
4021	-	47	-	62	Brass



4009



4010



4014



4019



4021



4020



4011



4013



4012

	⊕	↔	↑	↓	Material
4038	-	39	-	50	Brass
4039	-	37	-	45	Brass
4041	-	24	-	40	Brass
4042	-	40	-	24	Brass
4043	-	20	-	57	Brass
4044	-	19	-	53	Brass
4045	-	23	-	47	Brass
4046	-	52	-	-	Brass
4047	-	36	-	-	Brass

FINITURE / FINISHING



linea
Classic
Old Style

OTTONE PRESSOFUSO
BRASS DIE-CAST



4027

4025

4026

4023

4024

4028

	⊕	↔	↑	↓	Material
4023	-	43	-	65	Brass
4024	-	42	-	63	Brass
4025	-	39	-	59	Brass
4026	-	35	-	44	Brass
4027	-	36	-	150	Brass
4028	-	32	-	63	Brass
4093	-	23	-	34	Brass
4094	-	40	-	56	Brass
4095	-	30	-	42	Brass



> 4097/VE vertical
4097/OR horizontal
4097/PL plate

4100

4098



4094

4095

4096

FINITURE / FINISHING



4099

4093



4061



4064



4065



4063



4066



4069



4068



4091



4102



4088



4103



4092



4101



4089

linea Classic Old Style

OTTONE PRESSOFUSO
BRASS DIE-CAST



	⊕	↔	↑	↓	Material
4061	-	37	-	49	Brass
4063	-	20	-	32	Brass
4064	-	21	-	33	Brass
4065	-	14	-	29	Brass
4066	-	16	-	31	Brass
4068	-	16	-	29	Brass
4069	-	13	-	22	Brass
4088	-	22	-	42	Brass
4089	-	51	-	39	Brass

	⊕	↔	↑	↓	Material
4091	-	31	-	92	Brass
4092	-	20	-	158	Brass
4101	-	60	-	62	Brass
4102	-	14	-	23	Brass
4103	-	13	-	21	Brass

FINITURE / FINISHING



linea
Classic
Old Style

OTTONE PRESSOFUSO
BRASS DIE-CAST



4048



4049 



4050



4051



4052



4053







4054 







4055



4056

					Material
4048	-	21	-	35	Brass
4049	-	30	-	44	Brass
4050	-	30	-	-	Brass
4051	-	35	-	43	Brass
4052	-	29	-	38	Brass
4053	-	26	-	36	Brass
4054	-	46	-	-	Brass
4055	-	25	-	-	Brass
4056	-	29	-	-	Brass

					Material
4080	-	84	-	30	Brass
4081	-	40	-	62	Brass
4082	-	39	-	63	Brass
4083	-	63	-	39	Brass
4084	-	63	-	39	Brass
4104	-	109	-	33	Brass
4105	-	83	-	33	Brass
4107	-	79	-	34	Brass



4082

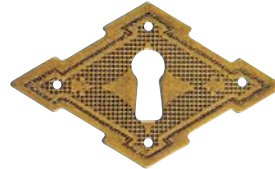

4084

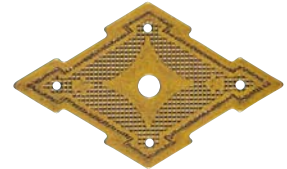

4083 plate



4107



4104



4081 



4105



4080

FINITURE / FINISHING



01

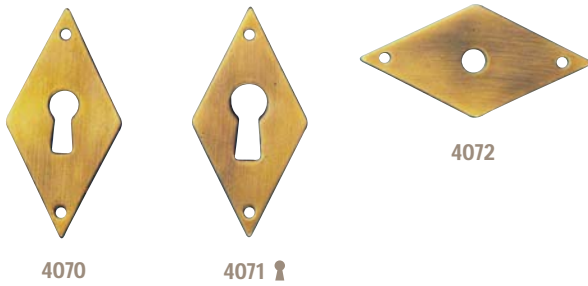

4070

4071 

4072

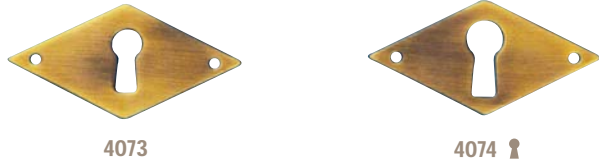

4073

4074 

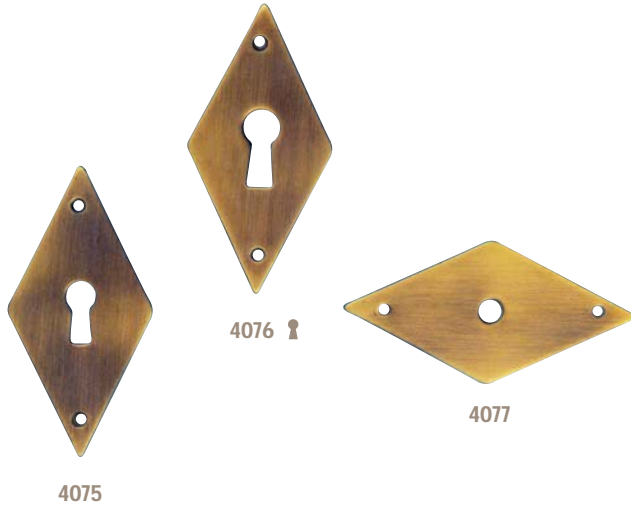

4075

4076 

4077

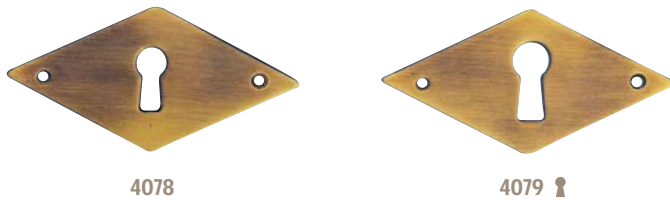

4078

4079 



4086





4087





4087

linea
Classic
Old Style

OTTONE PRESSOFUSO
BRASS DIE-CAST



					Material
4057	-	25	-	41	Brass
4070	-	28	-	56	Brass
4071	-	28	-	56	Brass
4072	-	56	-	28	Brass
4073	-	56	-	28	Brass
4074	-	56	-	28	Brass
4075	-	35	-	70	Brass
4076	-	35	-	70	Brass
4077	-	70	-	35	Brass

					Material
4078	-	70	-	35	Brass
4079	-	70	-	35	Brass
4086	-	15	-	119	Brass
4087	-	14	-	69	Brass

FINITURE / FINISHING

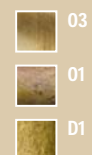

linea
Classic
Old Style

OTTONE FUSO IN TERRA
BRASS SAND-CAST



	⊕	↔	↑	↓	Material
1005/A	-	123	-	33	Brass
1005/B	-	82	-	22	Brass
1009	-	118	-	20	Brass
1010/A	-	114	-	59	Brass
1010/B	-	111	-	43	Brass
1010/C	-	72	-	25	Brass
1048/A	-	120	-	43	Brass
1048/B	-	94	-	33	Brass
1049/A	-	128	-	46	Brass

	⊕	↔	↑	↓	Material
1049/B	-	82	-	27	Brass
1050/CF	-	24	-	130	Brass
1050/SF	-	24	-	130	Brass
4080	-	84	-	30	Brass
4104	-	109	-	33	Brass
4105	-	83	-	33	Brass



1010/A



1010/B



1009



4105



1010/C



1005/A



1005/B



4104



1050/SF



1048/A



1048/B



1049/A



1049/B



1050/CF



4080

FINITURE / FINISHING



01



1006/A



1007



1008



1006/B



1003



1004



4104



1057/B



1057/A



1014/A



1014/B



4104



1013



1012



4107



4105

linea Classic Old Style

OTTONE FUSO IN TERRA
BRASS SAND-CAST



	⊕	↔	↑	↓	Material
1003	-	34	-	125	Brass
1004	-	34	-	125	Brass
1006/A	-	130	-	35	Brass
1006/B	-	90	-	26	Brass
1007	-	23	-	118	Brass
1008	-	23	-	118	Brass
1012	-	23	-	110	Brass
1013	-	125	-	27	Brass
1014/A	-	140	-	26	Brass

	⊕	↔	↑	↓	Material
1014/B	-	110	-	20	Brass
1057/A	-	55	-	72	Brass
1057/B	-	44	-	55	Brass
4104	-	109	-	33	Brass
4105	-	83	-	33	Brass
4107	-	79	-	34	Brass

FINITURE / FINISHING



01

linea
Classic
Old Style

LAMIERINO DI OTTONE
BRASS FOIL



	⊕ ⊖	↔	↑	↓	Material
9000/A1	-	80	-	60	Brass Foil
9000/A2	-	80	-	60	Brass Foil
9000/A3	-	76	-	57	Brass Foil
9000/B1	-	66	-	46	Brass Foil
9000/B2	-	66	-	46	Brass Foil
9000/B3	-	61	-	46	Brass Foil
9001/A1	-	80	-	60	Brass Foil
9001/A2	-	80	-	60	Brass Foil
9001/A3	-	76	-	57	Brass Foil

	⊕ ⊖	↔	↑	↓	Material
9001/B1	-	66	-	46	Brass Foil
9001/B2	-	66	-	46	Brass Foil
9001/B3	-	61	-	46	Brass Foil
9004/A1	-	80	-	60	Brass Foil
9004/A2	-	80	-	60	Brass Foil
9004/A3	-	76	-	57	Brass Foil
9004/B1	-	66	-	46	Brass Foil
9004/B2	-	66	-	46	Brass Foil
9004/B3	-	61	-	46	Brass Foil



> 9000/A1
9000/A2



> 9000/B1
9000/B2



9000/A3
> 9000/B3



> 9001/A1
9001/A2



> 9001/B1
9001/B2



> 9001/A3
9001/B3



> 9004/A1
9004/A2



> 9004/B1
9004/B2



> 9004/A3
9004/B3

FINITURE / FINISHING



01



> 9005/A1
9005/A2



9005/A3
> 9005/B3



> 9005/B1
9005/B2



> 9002/A1
9002/A2



> 9002/B1
9002/B2



> 9002/A3
9002/B3



> 9003/A1
9003/A2



> 9003/B1
9003/B2



9003/A3
> 9003/B3

linea
Classic
Old Style

LAMIERINO DI OTTONE
BRASS FOIL



	⊕ ⊕	↔	↑	↓	Material
9002/A1	-	80	-	60	Brass Foil
9002/A2	-	80	-	60	Brass Foil
9002/A3	-	76	-	57	Brass Foil
9002/B1	-	66	-	46	Brass Foil
9002/B2	-	66	-	46	Brass Foil
9002/B3	-	61	-	46	Brass Foil
9003/A1	-	80	-	60	Brass Foil
9003/A2	-	80	-	60	Brass Foil
9003/A3	-	76	-	57	Brass Foil

	⊕ ⊕	↔	↑	↓	Material
9003/B1	-	66	-	46	Brass Foil
9003/B2	-	66	-	46	Brass Foil
9003/B3	-	61	-	46	Brass Foil
9005/A1	-	80	-	60	Brass Foil
9005/A2	-	80	-	60	Brass Foil
9005/A3	-	76	-	57	Brass Foil
9005/B1	-	66	-	46	Brass Foil
9005/B2	-	66	-	46	Brass Foil
9005/B3	-	61	-	46	Brass Foil

FINITURE / FINISHING



01

linea
Classic
Old Style

LAMIERINO DI OTTONE
BRASS FOIL



	⊕	↔	↑	↓	Material
9006/A1	-	80	-	60	Brass Foil
9006/A2	-	80	-	60	Brass Foil
9006/A3	-	76	-	57	Brass Foil
9006/B1	-	66	-	46	Brass Foil
9006/B2	-	66	-	46	Brass Foil
9006/B3	-	61	-	46	Brass Foil
9007/A1	-	80	-	60	Brass Foil
9007/A2	-	80	-	60	Brass Foil
9007/A3	-	76	-	57	Brass Foil

	⊕	↔	↑	↓	Material
9007/B1	-	66	-	46	Brass Foil
9007/B2	-	66	-	46	Brass Foil
9007/B3	-	61	-	46	Brass Foil
9008/A1	-	80	-	60	Brass Foil
9008/A2	-	80	-	60	Brass Foil
9008/A3	-	76	-	57	Brass Foil
9008/B1	-	66	-	46	Brass Foil
9008/B2	-	66	-	46	Brass Foil
9008/B3	-	61	-	46	Brass Foil



> 9008/A1
9008/A2



> 9008/B1
9008/B2



> 9008/A3
9008/B3



> 9006/A1
9006/A2



> 9006/B1
9006/B2



> 9006/A3
9006/B3



> 9007/A1
9007/A2



> 9007/B1
9007/B2



9007/A3
> 9007/B3

FINITURE / FINISHING



01



> 9026/A1
9026/A2



9026/A3



> 9027/A1
9027/A2



> 9027/B1
9027/B2



> 9027/A3
9027/B3



9025/A1



9025/B1



9025/A3
> 9025/B3

linea
Classic
Old Style

LAMIERINO DI OTTONE
BRASS FOIL



	⊕	↔	↑	↓	Material
9025/A1	-	58	-	-	Brass Foil
9025/A3	-	58	-	-	Brass Foil
9025/B1	-	47	-	-	Brass Foil
9025/B3	-	47	-	-	Brass Foil
9026/A1	-	81	-	51	Brass Foil
9026/A2	-	81	-	51	Brass Foil
9026/A3	-	78	-	46	Brass Foil
9027/A1	-	79	-	60	Brass Foil
9027/A2	-	79	-	60	Brass Foil

	⊕	↔	↑	↓	Material
9027/A3	-	76	-	57	Brass Foil
9027/B1	-	66	-	47	Brass Foil
9027/B2	-	66	-	47	Brass Foil
9027/B3	-	63	-	47	Brass Foil

FINITURE / FINISHING



linea
Classic
Old Style

LAMIERINO DI OTTONE
BRASS FOIL



	⊕	↔	↑	↓	Material
9018/A1	-	76	-	57	Brass Foil
9018/A2	-	76	-	57	Brass Foil
9018/B1	-	62	-	47	Brass Foil
9018/B2	-	62	-	47	Brass Foil
9019/A1	-	76	-	57	Brass Foil
9019/A2	-	76	-	57	Brass Foil
9019/B1	-	62	-	47	Brass Foil
9019/B2	-	62	-	47	Brass Foil
9020/A1	-	76	-	57	Brass Foil

	⊕	↔	↑	↓	Material
9020/A2	-	76	-	57	Brass Foil
9020/B1	-	62	-	47	Brass Foil
9020/B2	-	62	-	47	Brass Foil
9021/A1	-	76	-	57	Brass Foil
9021/A2	-	76	-	57	Brass Foil
9021/B1	-	62	-	47	Brass Foil
9021/B2	-	62	-	47	Brass Foil
9024/A1	-	64	-	79	Brass Foil
9024/A3	-	64	-	-	Brass Foil

	⊕	↔	↑	↓	Material
9024/B1	-	50	-	62	Brass Foil
9024/B3	-	50	-	-	Brass Foil

FINITURE / FINISHING



01



9024/A1



9024/B1



9024/A3 🔑
> 9024/B3 🔑



> 9018/A1 🔑
9018/A2 🔑



> 9018/B1 🔑
9018/B2 🔑



> 9019/A1 🔑
9019/A2 🔑



> 9019/B1 🔑
9019/B2 🔑



> 9020/A1 🔑
9020/A2 🔑



> 9020/B1 🔑
9020/B2 🔑



> 9021/A1 🔑
9021/A2 🔑



> 9021/B1 🔑
9021/B2 🔑



> 9023/A1
9023/A2



9023/A3



9023/A4



9023/A5



9023/A6



9023/B1



9023/A7



9023/B3



9023/B2

linea
Classic
Old Style

LAMIERINO DI OTTONE
BRASS FOIL



	⊕	↔	↑	↓	Material
9023/A1	64	115	-	44	Brass Foil
9023/A2	64	115	-	44	Brass Foil
9023/A3	-	115	-	35	Brass Foil
9023/A4	-	35	-	115	Brass Foil
9023/A5	-	35	-	115	Brass Foil
9023/A6	-	35	-	115	Brass Foil
9023/A7	-	115	-	52	Brass Foil
9023/B1	-	115	-	52	Brass Foil
9023/B2	-	37	-	115	Brass Foil

	⊕	↔	↑	↓	Material
9023/B3	-	37	-	115	Brass Foil

FINITURE / FINISHING



linea
Classic
Old Style

LAMIERINO DI OTTONE
BRASS FOIL



	⊕	↔	↑	↓	Material
9015/A1	-	96	-	43	Brass Foil
9015/A2	-	96	-	43	Brass Foil
9015/A3	-	96	-	33	Brass Foil
9015/A4	-	33	-	100	Brass Foil
9015/A5	-	33	-	100	Brass Foil
9015/A6	-	33	-	96	Brass Foil
9015/A7	-	33	-	52	Brass Foil
9015/A8	-	33	-	36	Brass Foil
9028/A1	-	96	-	45	Brass Foil



> 9015/A1
9015/A2 🔑



9015/A3 🔑



9015/A4



9015/A5 🔑



9015/A6 🔑



9015/A7



9015/A8 🔑

	⊕	↔	↑	↓	Material
9028/A2	-	96	-	45	Brass Foil
9028/A3	-	96	-	33	Brass Foil
9028/A4	-	33	-	99	Brass Foil
9028/A5	-	33	-	99	Brass Foil
9028/A6	-	33	-	96	Brass Foil



> 9028/A1
9028/A2 🔑



9028/A3 🔑



9028/A4



9028/A5 🔑



9028/A6 🔑

FINITURE / FINISHING





> 9013/A1
9013/A2



9013/A3



> 9014/A1
9014/A2



9014/A3

linea
Classic
Old Style

LAMIERINO DI OTTONE
BRASS FOIL



	⊕	↔	↑	↓	Material
9013/A1	-	96	-	37	Brass Foil
9013/A2	-	96	-	37	Brass Foil
9013/A3	-	96	-	33	Brass Foil
9014/A1	-	96	-	37	Brass Foil
9014/A2	-	96	-	37	Brass Foil
9014/A3	-	96	-	33	Brass Foil
9044/A1	64	94	-	43	Brass Foil
9044/A4	32	27	-	82	Brass Foil
9044/A5	32	27	-	82	Brass Foil



9044/A1



9044/B1



9044/B3

	⊕	↔	↑	↓	Material
9044/A6	-	27	-	82	Brass Foil
9044/B1	32	76	-	32	Brass Foil
9044/B3	-	76	-	32	Brass Foil



9044/A4



9044/A5



9044/A6

FINITURE / FINISHING

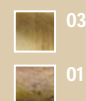

linea
Classic
Old Style

LAMIERINO DI OTTONE
BRASS FOIL



	⊕	↔	↑	↓	Material
9016/A1	-	97	-	45	Brass Foil
9016/A2	-	97	-	45	Brass Foil
9016/A3	-	97	-	33	Brass Foil
9016/A4	-	33	-	100	Brass Foil
9016/A5	-	33	-	100	Brass Foil
9016/A6	-	33	-	97	Brass Foil
9017/A1	-	95	-	44	Brass Foil
9017/A2	-	95	-	44	Brass Foil
9017/A3	-	95	-	33	Brass Foil



> 9016/A1
9016/A2



9016/A3



9016/A4



9016/A5



9016/A6

	⊕	↔	↑	↓	Material
9017/A4	-	33	-	103	Brass Foil
9017/A5	-	33	-	103	Brass Foil
9017/A6	-	33	-	95	Brass Foil



> 9017/A1
9017/A2



9017/A3



9017/A4



9017/A5



9017/A6

FINITURE / FINISHING



01



> 9029/A1
9029/A2



9029/A3



9029/A4



9029/A5



9029/A6

linea
Classic
Old Style

LAMIERINO DI OTTONE
BRASS FOIL



	⊕ ⊕	↔	↑	↓	Material
9029/A1	-	96	-	44	Brass Foil
9029/A2	-	96	-	44	Brass Foil
9029/A3	-	96	-	33	Brass Foil
9029/A4	-	33	-	101	Brass Foil
9029/A5	-	33	-	101	Brass Foil
9029/A6	-	33	-	96	Brass Foil
9030/A1	-	96	-	44	Brass Foil
9030/A2	-	96	-	44	Brass Foil
9030/A3	-	96	-	33	Brass Foil



> 9030/A1
9030/A2



9030/A3



9030/A4



9030/A5



9030/A6

	⊕ ⊕	↔	↑	↓	Material
9030/A4	-	33	-	99	Brass Foil
9030/A5	-	33	-	99	Brass Foil
9030/A6	-	33	-	96	Brass Foil

FINITURE / FINISHING



01

linea
Classic
Old Style

LAMIERINO DI OTTONE
BRASS FOIL



	⊕	↔	↑	↓	Material
9022/A1	-	129	-	56	Brass Foil
9022/A2	-	129	-	56	Brass Foil
9022/A3	-	129	-	43	Brass Foil
9022/A4	-	43	-	129	Brass Foil
9022/A5	-	43	-	129	Brass Foil
9022/A6	-	43	-	129	Brass Foil
9022/B1	64	104	-	46	Brass Foil
9022/B2	64	104	-	46	Brass Foil
9022/B3	-	104	-	35	Brass Foil



> 9022/A1
9022/A2



9022/A3



9022/A4



9022/A5



9022/A6

	⊕	↔	↑	↓	Material
9022/B4	-	35	-	104	Brass Foil
9022/B5	-	35	-	104	Brass Foil
9022/B6	-	35	-	104	Brass Foil



> 9022/B1
9022/B2



9022/B3



9022/B4



9022/B5



9022/B6

FINITURE / FINISHING



15



01



> 9012/A1
9012/A2 🔑



9012/A3 🔑



9012/A4



9012/A5 🔑



9012/A6 🔑

linea
Classic
Old Style

LAMIERINO DI OTTONE
BRASS FOIL



	⊕⊕	↔	↑	↓	Material
9012/A1	-	116	-	47	Brass Foil
9012/A2	-	116	-	47	Brass Foil
9012/A3	-	116	-	37	Brass Foil
9012/A4	-	37	-	116	Brass Foil
9012/A5	-	37	-	116	Brass Foil
9012/A6	-	37	-	116	Brass Foil
9012/B1	-	95	-	40	Brass Foil
9012/B2	-	95	-	40	Brass Foil
9012/B3	-	95	-	30	Brass Foil



> 9012/B1
9012/B2



9012/B3



9012/B4



9012/B5



9012/B6

	⊕⊕	↔	↑	↓	Material
9012/B4	-	30	-	95	Brass Foil
9012/B5	-	30	-	95	Brass Foil
9012/B6	-	30	-	95	Brass Foil

FINITURE / FINISHING

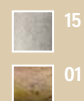

linea
Classic
Old Style

LAMIERINO DI OTTONE
BRASS FOIL



	⊕ ⊖	↔	↑	↓	Material
9010/A1	-	100	-	50	Brass Foil
9010/A2	-	100	-	50	Brass Foil
9010/A3	-	100	-	36	Brass Foil
9034	-	35	-	75	Brass Foil
9035	-	32	-	90	Brass Foil
9036	-	40	-	124	Brass Foil
9037	-	65	-	83	Brass Foil
9038	-	69	-	69	Brass Foil
9039	-	67	-	77	Brass Foil



> 9010/A1
9010/A2



9010/A3



9036



9035



9034



9037



9039



9038

FINITURE / FINISHING



01



9043/A1



9043/A3



9031



9032



9033



9041

linea
Classic
Old Style

LAMIERINO DI OTTONE
BRASS FOIL



	⊕⊕	↔	↑	↓	Material
9031	-	40	-	163	Brass Foil
9032	-	48	-	137	Brass Foil
9033	-	45	-	119	Brass Foil
9041	-	52	-	163	Brass Foil
9043/A1	-	98	-	53	Brass Foil
9043/A3	-	98	-	41	Brass Foil

FINITURE / FINISHING



linea
Classic
Old Style

LAMIERINO DI OTTONE - PLASTICA
BRASS FOIL - PLASTIC



	↔	↔	↑	↓	Material
4106	-	35	-	43	Plastic
9500/A	128	46	-	199	Plastic
9500/B	96	159	-	36	Plastic
9500/C	64	112	-	26	Plastic
9501	-	35	-	43	Plastic
9502	-	28	-	38	Plastic



9500/A



4106



9502



9501



9500/B



9500/C

FINITURE / FINISHING



43



9500/A



4106



9502



9501

linea
Classic
Old Style

LAMIERINO DI OTTONE - PLASTICA
BRASS FOIL - PLASTIC



	⊕ ⊕	↔	↑	↓	Material
4106	-	35	-	43	Plastic
9500/A	128	46	-	199	Plastic
9500/B	96	159	-	36	Plastic
9500/C	64	112	-	26	Plastic
9501	-	35	-	43	Plastic
9502	-	28	-	38	Plastic



9500/B



9500/C

FINITURE / FINISHING



42

linea
Classic
Old Style

FERRO
IRON



	⊕	↔	↑	↓	Material
0500/A	(50)	50	-	52	Iron
0500/B	(45)	45	-	47	Iron
0500/C	(40)	40	-	42	Iron
0500/D	(35)	35	-	37	Iron
0500/E	(35)	35	-	37	Iron
0500/F	(22)	22	-	24	Iron
0527	-	28	-	56	Iron
0528	-	28	-	56	Iron
0529	-	56	-	28	Iron

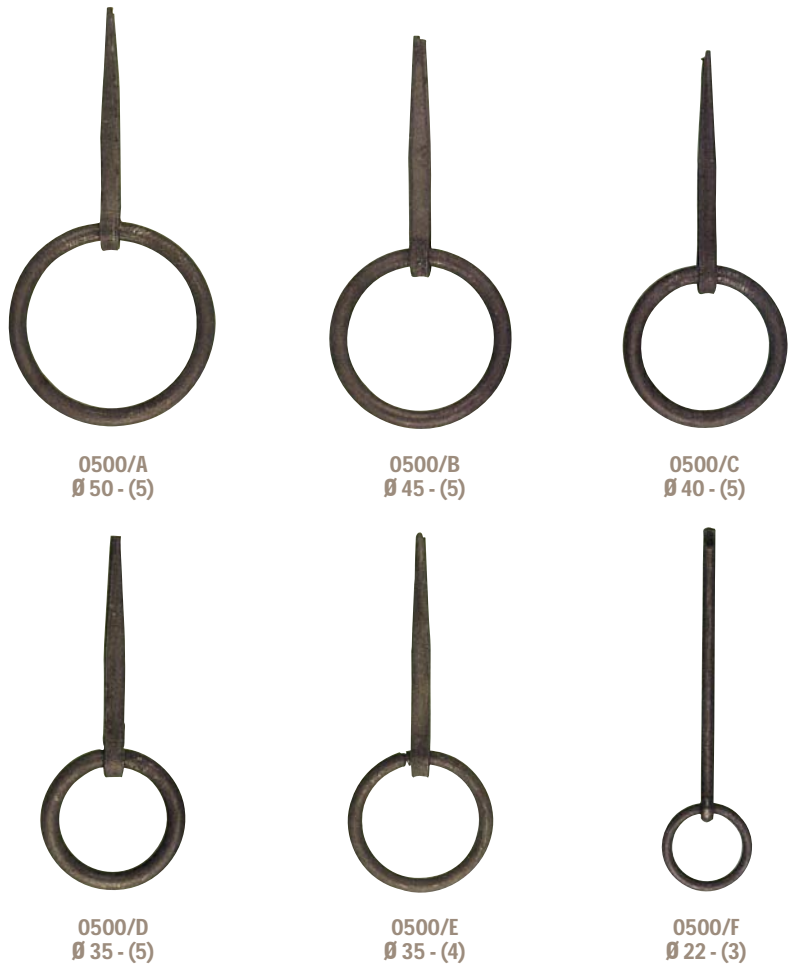

	⊕	↔	↑	↓	Material
0530	-	56	-	28	Iron
0531	-	56	-	28	Iron
0532	-	35	-	70	Iron
0533	-	35	-	70	Iron
0534	-	70	-	35	Iron
0535	-	70	-	35	Iron
0536	-	70	-	35	Iron

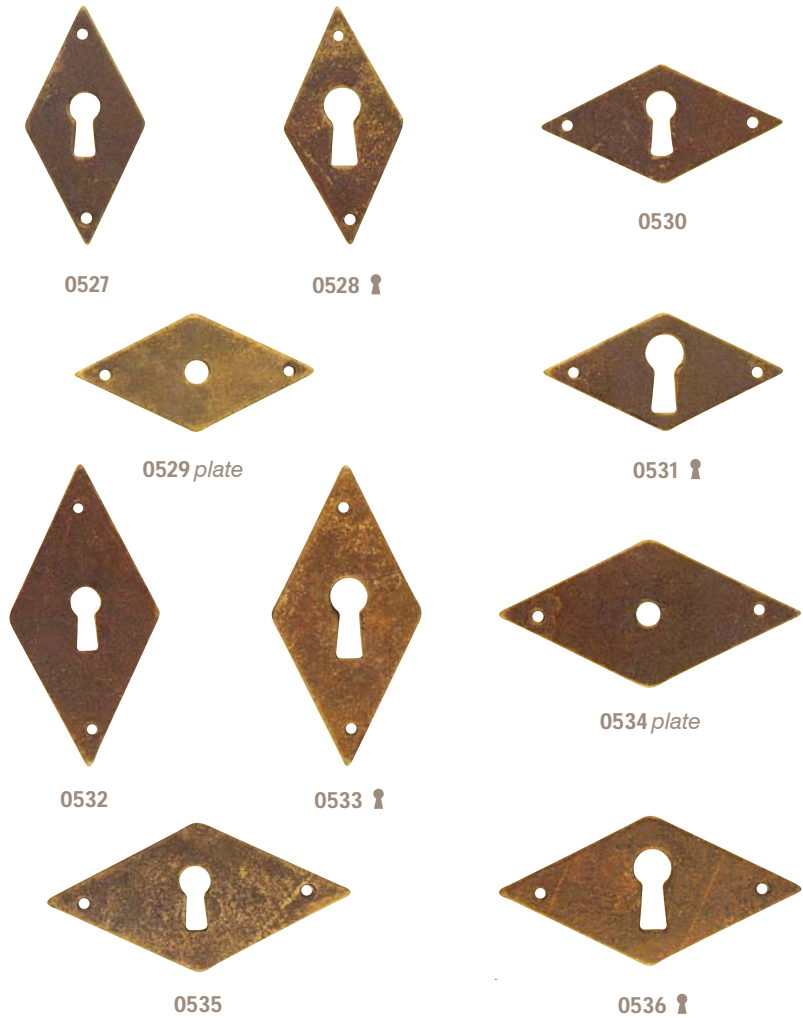

FINITURE / FINISHING





0526/A1



0526/A3 



0526/B1



0526/B3



0526/B2 



0526/A6 



0557 







0542 

linea
Classic
Old Style

FERRO
IRON



					Material
0526/A1	64	115	-	46	Iron
0526/A3	-	115	-	37	Iron
0526/A6	-	37	-	115	Iron
0526/B1	-	115	-	51	Iron
0526/B2	-	37	-	115	Iron
0526/B3	-	37	-	115	Iron
0542	-	30	-	100	Iron
0557	-	36	-	105	Iron

FINITURE / FINISHING

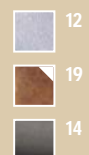

linea
Classic
Old Style

FERRO
IRON



0504 Ø 6

0505 Ø 7

0506 Ø 8



0537 Ø 6
euro

0507 Ø 7
special Z

0508 Ø 8
special T

	⊕	↔	↑	↓	Material
0504	6	25	-	71	Iron
0505	7	28	-	80	Iron
0506	8	29	-	89	Iron
0507	7	37	-	88	Iron
0508	8	29	-	88	Iron
0513	6	25	-	79	Iron
0514	7	27	-	90	Iron
0520	6	38	-	88	Iron
0521	8	38	-	90	Iron

	⊕	↔	↑	↓	Material
0537	6	25	-	70	Iron



0514 Ø 7



0513 Ø 6



0521 Ø 8



0520 Ø 6
special Z

FINITURE / FINISHING





0519 Ø 6
euro



0547 Ø 6
euro



0518 Ø 6
euro



0517 Ø 6
euro



0548 Ø 7



0549 Ø 6



0550 Ø 5



0551 Ø 5

linea
Classic
Old Style

FERRO
IRON



	⊕⊕	↔	↑	↓	Material
0509	6	30	-	77	Iron
0510	6	30	-	71	Iron
0511	8	30	-	86	Iron
0512	8	30	-	80	Iron
0515	6	34	-	94	Iron
0516	6	35	-	87	Iron
0517	6	26	-	80	Iron
0518	6	26	-	70	Iron
0519	6	22	-	50	Iron



0509 Ø 6



0511 Ø 8



0510 Ø 6



0512 Ø 8



0515 Ø 6



0516 Ø 6

	⊕⊕	↔	↑	↓	Material
0547	6	23	-	59	Iron
0548	7	25	-	81	Iron
0549	6	23	-	69	Iron
0550	5	21	-	60	Iron
0551	5	21	-	53	Iron

FINITURE / FINISHING

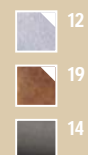

linea
Classic
Old Style

FERRO
IRON



	⊕	↔	↑	↓	Material
0501/25	-	25	18	-	Iron
0501/30	-	30	21	-	Iron
0501/35	-	35	28	-	Iron
0502/28	-	28	23	-	Iron
0502/34	-	34	27	-	Iron
0503/25	-	25	24	-	Iron
0503/34	-	34	34	-	Iron
0543	-	52	-	163	Iron
0544	-	68	-	169	Iron

	⊕	↔	↑	↓	Material
0545	-	52	-	52	Iron
0546	-	40	-	57	Iron
0552/25	-	25	18	-	Iron
0552/30	-	30	21	-	Iron
0552/35	-	35	26	-	Iron
0553/25	-	25	20	-	Iron
0553/30	-	30	22	-	Iron

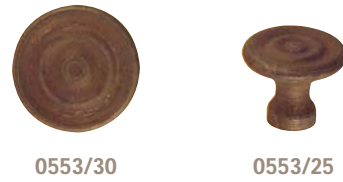
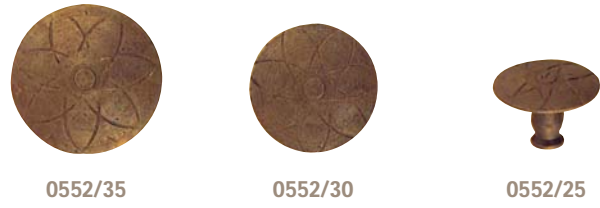

0543 🔑



0544 🔑



0545



0546 🔑

FINITURE / FINISHING





0522/A



0522/B



0522/C



0538



0539



0540



0554



0555 



0556



0523



0524



0541 







0525 

linea
Classic
Old Style

FERRO
IRON



					Material
0522/A	-	98	-	40	Iron
0522/B	-	78	-	33	Iron
0522/C	-	65	-	28	Iron
0523	-	76	-	25	Iron
0524	-	25	-	76	Iron
0525	-	43	-	165	Iron
0538	-	40	-	57	Iron
0539	-	30	-	42	Iron
0540	-	23	-	32	Iron

					Material
0541	-	38	-	90	Iron
0554	-	90	-	51	Iron
0555	-	90	-	38	Iron
0556	-	90	-	38	Iron

FINITURE / FINISHING

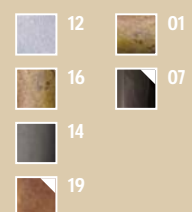

linea
Classic
Old Style

VARIE
MISCELLANEOUS



mm 29 x 16

0001



mm 22 x 13

0002



mm 30 x 16

0005

	⊕	↔	↑	↓	Material
0001	-	42	-	74	Brass
0002	-	31	-	57	Brass
0003	-	50	-	77	Brass
0028	-	98	-	55	Brass
0034	-	29	-	83	Brass
0035	-	23	-	62	Brass
0037/43	-	43	-	-	Brass
0038/34	-	34	-	-	Brass
0039/28	-	28	-	-	Brass

	⊕	↔	↑	↓	Material
0040/20	-	20	-	-	Brass
0040/24	-	24	-	-	Brass



0037/43



0038/34



0039/28



0040/24



0040/20



0028



0034



0035

FINITURE / FINISHING

	E8		O3
	I0		O4
	S0		O1
	A8		D1



0058



0059



0060



0061



0064



0065



0066



0067



0062



0063



0074



0075



0073

linea Classic Old Style

VARIE
MISCELLANEOUS



	⊕⊕	↔	↑	↓	Material
0058	-	58	-	-	Brass Foil
0059	-	45	-	-	Brass Foil
0060	-	31	-	-	Brass Foil
0061	-	20	-	-	Brass Foil
0062	-	90	-	30	Brass Foil
0063	-	73	-	25	Brass Foil
0064	-	18	-	97	Brass Foil
0065	-	15	-	60	Brass Foil
0066	-	24	-	84	Brass Foil

	⊕⊕	↔	↑	↓	Material
0067	-	42	-	27	Brass Foil
0073	-	42	-	144	Brass Foil
0074	-	42	-	116	Brass Foil
0075	-	31	-	76	Brass Foil

FINITURE / FINISHING

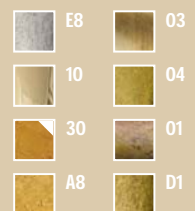

linea
Classic
Old Style

VARIE
MISCELLANEOUS



	⊕ ⊖	↔	↑	↓	Material
0022	-	155	-	53	Brass
0023	-	147	-	48	Brass
0025	-	164	-	44	Brass
0026	-	182	-	44	Brass
0027	-	162	-	145	Brass
0028	-	98	-	55	Brass
0031/DX	-	40	-	57	Brass Foil
0031/SX	-	40	-	57	Brass Foil



0022



0025



0026



0023



0027
mm 162 x 145



0031/SX



0031/DX

FINITURE / FINISHING

	A8		01
	30		D1
	03		
	04		



0068
mm 227 x 70



0069
mm 205 x 50



0070
mm 243 x 65



0071
mm 190 x 37



0072
mm 160 x 55

linea
Classic
Old Style

VARIE
MISCELLANEOUS



	⊕⊕	↔	↑	↓	Material
0068	-	227	-	70	Brass
0069	-	205	-	50	Brass
0070	-	243	-	65	Brass
0071	-	190	-	37	Brass
0072	-	160	-	55	Brass

FINITURE / FINISHING

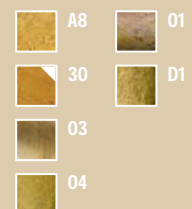

linea
Classic
Old Style

VARIE
MISCELLANEOUS



0024



0055



0054

	⊕ ⊕	↔	↑	↓	Material
0024	-	172	-	52	Brass
0029	-	31	-	78	Brass
0030	-	24	-	56	Brass
0054	-	39	-	63	Brass
0055	-	25	-	108	Brass
0076	-	29	-	134	Brass
0077	-	43	-	120	Brass
0078	-	37	-	122	Brass



0076



0077



0078

FINITURE / FINISHING

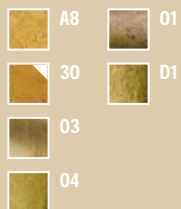

0030



0029



0079
esclusiva



0080
esclusiva



0081
esclusiva



0083



0082
esclusiva



0084

linea
Classic
Old Style

VARIE
MISCELLANEOUS



	⊕	↔	↑	↓	Material
0004	-	90	-	130	Brass
0079	-	95	-	60	Brass
0080	-	70	-	53	Brass
0081	-	47	-	90	Brass
0082	-	38	-	67	Brass
0083	-	49	-	51	Brass
0084	-	39	-	41	Brass
1020/A	-	61	-	85	Brass
1020/B	-	42	-	58	Brass



0004



1020/A



1020/B

FINITURE / FINISHING

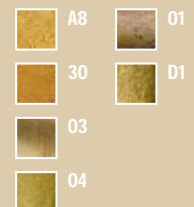

linea
Classic
Old Style

VARIE
MISCELLANEOUS



0012/A Ø 53
> 0013/A Ø 53 1/2
0014/A Ø 47
0015/A Ø 47 1/2



0012/B Ø 53
> 0013/B Ø 53 1/2
0014/B Ø 47
0015/B Ø 47 1/2



0016/A Ø 40
> 0017/A Ø 40 1/2



0016/B Ø 40
> 0017/B Ø 40 1/2

	⊕	↔	↑	↓	Material
0012/A	-	69	-	48	Brass Foil
0012/B	-	69	-	27	Brass Foil
0013/A	-	69	-	48	Brass Foil
0013/B	-	69	-	27	Brass Foil
0014/A	-	64	-	45	Brass Foil
0014/B	-	64	-	26	Brass Foil
0015/A	-	64	-	45	Brass Foil
0015/B	-	64	-	26	Brass Foil
0016/A	-	55	-	41	Brass Foil

	⊕	↔	↑	↓	Material
0016/B	-	55	-	26	Brass Foil
0017/A	-	55	-	41	Brass Foil
0017/B	-	55	-	26	Brass Foil
0018/A	-	46	-	37	Brass Foil
0018/B	-	46	-	26	Brass Foil
0019/A	-	46	-	37	Brass Foil
0019/B	-	46	-	26	Brass Foil
0020/A	-	37	-	32	Brass Foil
0020/B	-	37	-	25	Brass Foil

	⊕	↔	↑	↓	Material
0021/A	-	37	-	32	Brass Foil
0021/B	-	37	-	25	Brass Foil
0057	-	35	-	70	Brass



0018/A Ø 33
0019/A Ø 33 1/2
0020/A Ø 25
> 0021/A Ø 25 1/2



0018/B Ø 33
0019/B Ø 33 1/2
0020/B Ø 25
> 0021/B Ø 25 1/2



0057
Ø int. 24 mm

FINITURE / FINISHING

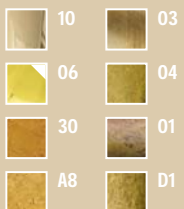



0006/A



0051



0052



0007/B



0008/30



0008/25



0009/20



0010/30



0010/24



0053



0011/A



0099/10



MARCHI IN METALLO PERSONALIZZATI / METAL LOGOTYPES CUSTOMIZED



0046



0050



0049



0048



0047

linea
Classic
Old Style

VARIE
MISCELLANEOUS





	⊕	↔	↑	↓	Material
0006/A	-	79	-	38	Zamak
0007/B	-	58	-	27	Zamak
0008/25	-	25	-	-	Zamak
0008/30	-	30	-	-	Zamak
0009/20	-	20	-	-	Zamak
0010/24	-	24	-	-	Brass
0010/30	-	30	-	-	Brass
0011/A	-	30	-	-	Zamak
0099/10	-	10	-	-	Zamak

	⊕	↔	↑	↓	Material
0046	-	21	-	41	Steel
0047	-	16	-	34	Steel
0048	-	29	-	38	Steel
0049	-	22	-	35	Steel
0050	-	25	-	35	Steel
0051	-	46	-	42	Brass
0052	-	75	-	47	Brass
0053	-	20	-	-	Zamak

FINITURE / FINISHING

solo per cod: 0046 - 0047 - 0048 - 0049 - 0050
only for items: 0046 - 0047 - 0048 - 0049 - 0050

-  22 > NICHEL LUCIDO
POLISHED NICKEL
-  27 > RAME ANTICO
ANTIQUE COPPER
-  18 > ACCIAIO OTTONATO
BRASSED STEEL

FINITURE / FINISHING

-  E8
-  O4
-  A30
-  O1
-  A8
-  D1
-  O3

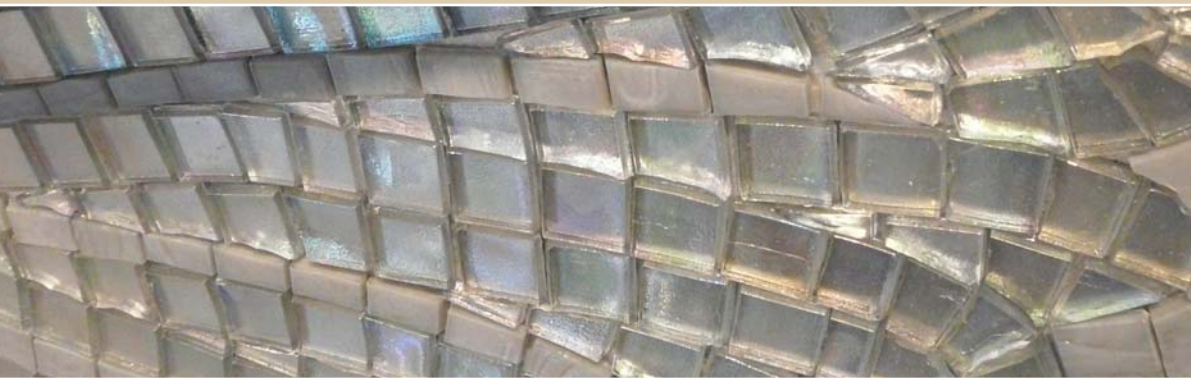



Romantic

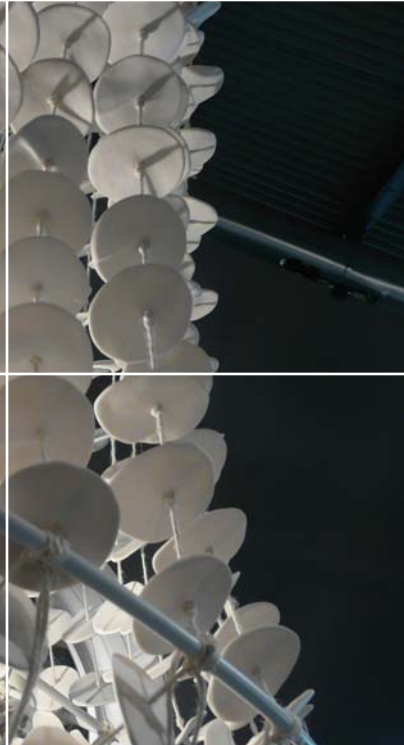
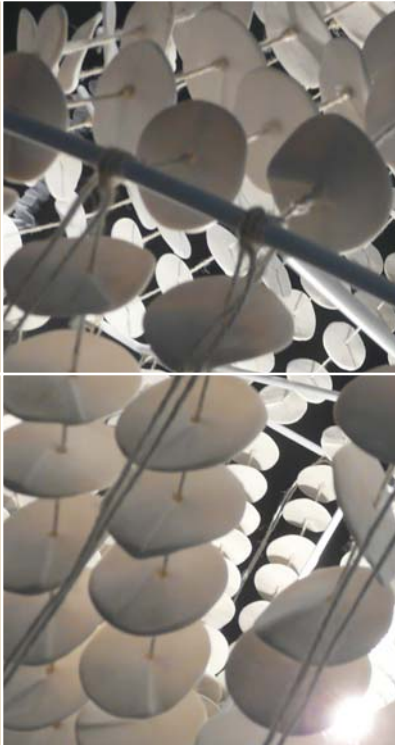

FINITURE LINEA ROMANTIC

ROMANTIC FINISHES

 **F7G** > VERNICIATO NICHEL SATINATO
VARNISHED NICKEL SATINED

 **CRG** > CROMO LUCIDO
POLISHED CHROME

 **15G** > ARGENTO VECCHIO (*)
OLD SILVER

 **E8G** > ARGENTO VECCHIO BRILLANTE
SHINY OLD SILVER

 **24G** > NICHEL VECCHIO
OLD NICKEL

 **B9G** > NICHEL VECCHIO COUNTRY
OLD NICKEL COUNTRY

 **20G** > FORGIA ANTICA
ANTIQUE FORGE

 **D2G** > GRIGIO MADREPERLA
GRAY MOTHER OF PEARL

 **R3G** > ARGENTO NOTTINGHAM
NOTTINGHAM SILVER

 **M5G** > ARGENTO VENEZIA
VENETIAN SILVER

 **T4G** > BIANCO VINTAGE ARGENTO
WHITE VINTAGE SILVER

 **M2G** > LACCATO AVORIO LUCIDO
SHINY IVORY

 **C1G** > RAME ANTICO COUNTRY [*]
ANTIQUE COPPER COUNTRY

 **27G** > RAME ANTICO
ANTIQUE COPPER

 **GPG** > PLACCATO ORO
GOLD PLATED

 **X4G** > BRONZO PARIGI
BRONZE PARIS

 **A8G** > ORVAL
ORVAL

 **R8G** > ORO MILANO
MILANO GOLD

 **R4G** > ORO ROMA
ROMA GOLD

 **T5G** > AVORIO VINTAGE ORO
IVORY VINTAGE GOLD

 **80G** > ANTICA ROMA
ANTIQUE ROME

 **D1G** > ANTICA FIRENZE [*]
ANTIQUE FLORENCE

 **O1G** > PATINATO
PATINATED

 **A9G** > PATINATO COUNTRY
PATINATED COUNTRY

 **B1G** > BRONZO COUNTRY [*]
BRONZE COUNTRY

 **C2G** > RUSTIKALL AVORIO [*]
RUSTIKALL IVORY

 **A6G** > NERO ALPI
BLACK ALPS



(*) FINITURA CONSIGLIATA / SUGGESTED FINISHING

SIMBOLOGIA

SYMBOLGY



INTERASSE
DISTANCE BETWEEN CENTRES



ALTEZZA
HEIGHT



DIAMETRO
DIAMETER



LUNGHEZZA
LENGHT



LARGHEZZA
WIDTH





Linea Romantic

SERIE M55



GIUSTI



M55



128	145	32	26



M55.00.00.E8G



M55.00.C5.E8G



M55.01.00.E8G



M55.01.D4.E8G



M55.01.00.D1G



M55.01.D5.D1G



M55.01.B6.D1G



M55.07.C8.D1G



M55.23.D1.E8G



M55.07.B7.E8G



M55.00.00.F7G



M55.01.D4.F7G

COMBINAZIONI / MATCHING

M55.00.00.00 > MODELLO / MODEL

M55.00.00.00 > SMALTO BIANCO
WHITE GLAZE

M55.01.00.00 > SMALTO AVORIO
IVORY GLAZE

M55.07.00.00 > SMALTO NERO LUCIDO
SHINY BLACK GLAZE

M55.23.00.00 > SMALTO NERO OPACO
MATT BLACK GLAZE

M55.00.00.00 > DECORO / ORNAMENT



M55.00.C3.CRG



M55.00.D4.CRG



M55.07.B7.CRG



M55.07.D2.CRG



M55.01.C5.F7G



M55.01.C3.F7G



M55.07.00.F7G

FINITURE METALLO / METAL FINISHING

D1G > ANTICA FIRENZE
ANTIQUE FLORENCE

E8G > ARGENTO VECCHIO BRILLANTE
SHINY OLD SILVER

CRG > CROMO LUCIDO
POLISHED CHROME

F7G > VERNICIATO NICHEL SATINATO
VARNISHED NICKEL SATINED

ALTRE COMBINAZIONI DISPONIBILI
OTHER COMBINATIONS AVAILABLE



Linea
Romantic
SERIE M56
GIUSTI

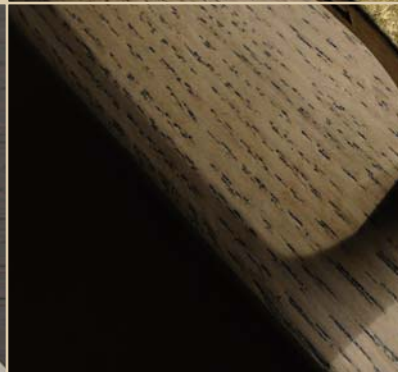

M56.01.00.D1G



M56.01.B8.D1G



M56.01.C7.D1G



M56.01.C1.D1G

COMBINAZIONI / MATCHING

M56.00.00.00 > MODELLO / MODEL

M56.00.00.00 > SMALTO BIANCO
WHITE GLAZE

M56.01.00.00 > SMALTO AVORIO
IVORY GLAZE

M56.00.00.00 > DECORO / ORNAMENT

M56



128	150	30	20



M56.01.00.F7G



M56.00.C6.F7G

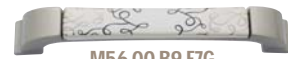

M56.00.B9.F7G



M56.01.00.E8G

FINITURE METALLO / METAL FINISHING

- D1G > ANTICA FIRENZE
ANTIQUÉ FLORENCE
- E8G > ARGENTO VECCHIO BRILLANTE
SHINY OLD SILVER
- CRG > CROMO LUCIDO
POLISHED CHROME
- F7G > VERNICIATO NICHEL SATINATO
VARNISHED NICKEL SATINED



M56.00.00.CRG



M56.00.C6.CRG

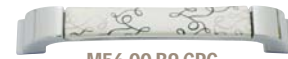

M56.00.B9.CRG

ALTRE COMBINAZIONI DISPONIBILI
OTHER COMBINATIONS AVAILABLE

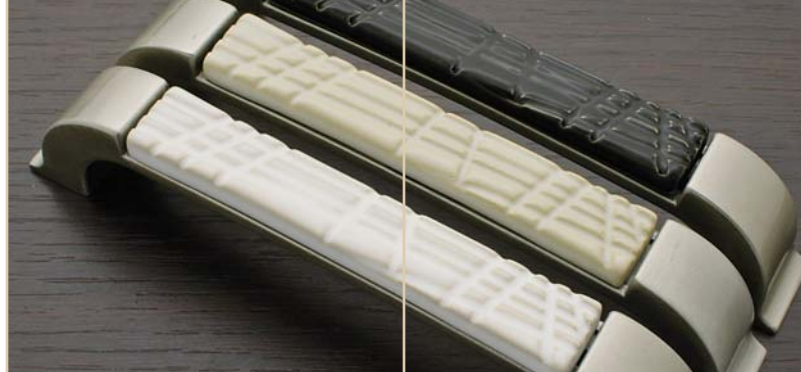

Linea Romantic

SERIE M56-XX



GIUSTI



M56.01.XX.D1G



M56.00.XX.E8G



M56.01.XX.E8G



M56.07.XX.E8G

M56.XX



128	150	30	20



M56.00.XX.F7G



M56.01.XX.F7G



M56.07.XX.F7G



M56.00.XX.CRG



M56.01.XX.CRG



M56.07.XX.CRG

COMBINAZIONI / MATCHING

M56.00.XX.00 > MODELLO / MODEL

M56.00.XX.00 > SMALTO BIANCO
WHITE GLAZE

M56.01.XX.00 > SMALTO AVORIO
IVORY GLAZE

M56.07.XX.00 > SMALTO NERO LUCIDO
SHINY BLACK GLAZE

M56.00.XX.00 > DECORO / ORNAMENT

FINITURE METALLO / METAL FINISHING

D1G > ANTICA FIRENZE
ANTIQUE FLORENCE

E8G > ARGENTO VECCHIO BRILLANTE
SHINY OLD SILVER

CRG > CROMO LUCIDO
POLISHED CHROME

F7G > VERNICIATO NICHEL SATINATO
VARNISHED NICKEL SATINED

ALTRE COMBINAZIONI DISPONIBILI
OTHER COMBINATIONS AVAILABLE

Linea Romantic

SERIE M62



GIUSTI



M62



96	112	33	16

P07



-	34	25	34

COMBINAZIONI / MATCHING

M62.00.00.00 > MODELLO / MODEL

M62.01.00.00 > SMALTO AVORIO
IVORY GLAZE

M62.00.00.00 > DECORO / ORNAMENT



M62.01.00.15G



M62.01.00.D1G



M62.01.A4.D1G



M62.01.90.15G



P07.01.00.15G



P07.01.00.D1G



P07.01.A4.D1G



P07.01.90.15G

FINITURE METALLO / METAL FINISHING

D1G > ANTICA FIRENZE
ANTIQUÉ FLORENCE

15G > ARGENTO VECCHIO
OLD SILVER



M62.01.B4.D1G



M62.01.A1.D1G



M62.01.81.D1G



P07.01.B4.D1G



P07.01.A1.D1G



P07.01.81.D1G

ALTRE COMBINAZIONI DISPONIBILI
OTHER COMBINATIONS AVAILABLE



Linea Romantic

SERIE PN1



GIUSTI

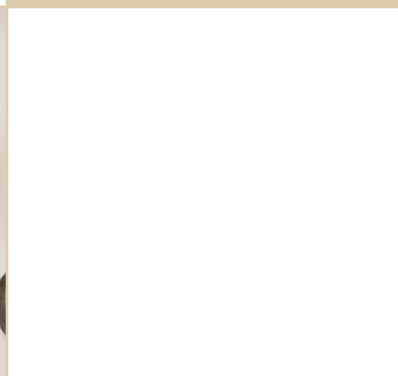

PN1.01.00.15



PN1.01.00.02



PN1.01.02.02



PN1.01.11.02



PN1

⌀	↔	⌈	⌋
-	22	22	60



PN1.01.10.15



PN1.01.12.02

COMBINAZIONI / MATCHING

PN1.00.00.00 > MODELLO / MODEL

PN1.00.00.00 > SMALTO BIANCO
WHITE GLAZE

PN1.01.00.00 > SMALTO AVORIO
IVORY GLAZE

PN1.02.00.00 > GRESS
GRESS

PN1.10.00.00 > PIETRA
STONE

PN1.00.00.00 > DECORO / ORNAMENT



PN1.01.68.02



PN1.01.81.02





PN1.01.90.15



PN1.01.B1.02

FINITURE METALLO / METAL FINISHING

 01 > PATINATO
PATINED

 02 > BRONZO
BRONZE

 15 > ARGENTO VECCHIO
OLD SILVER

ALTRE COMBINAZIONI DISPONIBILI
OTHER COMBINATIONS AVAILABLE



Linea Romantic

SERIE 188



GIUSTI



WMN188.096.01D1



⊕	↔	↑	↓
96	126	19	23



WMN188.096.AAD1



WMN188.096.BBD1



WMN188.096.CCD1



WMN188.096.DDD1

COMBINAZIONI / MATCHING

WMN188.000.0000 > MANIGLIA

HANDLE

WPO188.000.0000 > POMOLO

KNOB

WMN188.000.0000 > DECORO

ORNAMENT

WMN188.000.00D1 > METALLO

METAL

WMN188.064.01D1



⊕	↔	↑	↓
64	94	19	23



WMN188.064.AAD1



WMN188.064.BBD1



WMN188.064.CCD1



WMN188.064.DDD1

FINITURE METALLO / METAL FINISHING

 .00D1 > ANTICA FIRENZE
ANTIQUE FLORENCE

 .00E8 > ARGENTO VECCHIO BRILLANTE
SHINY OLD SILVER

WPO188.000.01D1



⊕	↔	↑	↓
-	31	19	31



WPO188.000.AAD1



WPO188.000.BBD1



WPO188.000.CCD1



WPO188.000.DDD1



Linea
Romantic

SERIE M63



GIUSTI



M63.00.00.D1G



M63.01.00.D1G



M63.07.00.D1G



M63.24.00.D1G



M63



32	107	29	35

M63.00.00.E8G



M63.01.00.E8G



M63.07.00.E8G



M63.24.00.E8G



SMALTO / GLAZE

- M63.00.00.D1G > BIANCO
WHITE
- M63.01.00.D1G > AVORIO
IVORY
- M63.07.00.D1G > NERO LUCIDO
SHINY BLACK
- M63.24.00.D1G > BORDEAUX
BORDEAUX

M63.00.00.F7G



M63.01.00.F7G



M63.07.00.F7G



M63.24.00.F7G



FINITURE METALLO / METAL FINISHING

- D1G > ANTICA FIRENZE
ANTIQUE FLORENCE
- E8G > ARGENTO VECCHIO BRILLANTE
SHINY OLD SILVER
- F7G > VERNICIATO NICHEL SATINATO
VARNISHED NICKEL SATINED



Linea Romantic

SERIE 110 - 120



GIUSTI





DECORI / ORNAMENT

-  .01D1
-  .06D1
-  .03D1
-  .81D1
-  .02D1

WMN120.128



			
128	156	30	28

INSERTI METALLO / METAL INSERT



-  .11D1 > ANTICA ROMA
ANTIQUE ROME
-  .D1D1 > ANTICA FIRENZE
ANTIQUE FLORENCE
-  .E8D1 > ARGENTO VEC. BRIL.
SHINY OLD SILVER
-  .F7D1 > VERN. NICHEL SAT.
VARN. NICKEL SAT.

WP0110.032



			
32	61	22	28

FINITURE METALLO / METAL FINISHING

-  .01D1 > ANTICA FIRENZE
ANTIQUE FLORENCE
-  .0111 > ANTICA ROMA
ANTIQUE ROME
-  .01E8 > ARGENTO VECCHIO BRILLANTE
SHINY OLD SILVER
-  .01F7 > VERNICIATO NICHEL SATINATO
VARNISHED NICKEL SATINED



Linea
Romantic

SERIE 110 - 122



GIUSTI



WMN122.128



128	152	30	48

DECORI / ORNAMENT

-  .01D1
-  .06D1
-  .03D1
-  .81D1
-  .02D1

WP0110.032







32	61	22	28

INSERTI METALLO / METAL INSERT

-  .11D1 > ANTICA ROMA
ANTIQUE ROME
-  .D1D1 > ANTICA FIRENZE
ANTIQUE FLORENCE
-  .E8D1 > ARGENTO VEC. BRIL.
SHINY OLD SILVER
-  .F7D1 > VERN. NICHEL SAT.
VARN. NICKEL SAT.

FINITURE METALLO / METAL FINISHING

-  .01D1 > ANTICA FIRENZE
ANTIQUE FLORENCE
-  .0111 > ANTICA ROMA
ANTIQUE ROME
-  .01E8 > ARGENTO VECCHIO BRILLANTE
SHINY OLD SILVER
-  .01F7 > VERNICIATO NICHEL SATINATO
VARNISHED NICKEL SATINED



Linea Romantic

SERIE M70



GIUSTI







FINITURE / FINISHING

-  C2G > RUSTIKALL AVORIO
RUSTIKALL IVORY
-  M2G > LACCATO AVORIO LUCIDO
SHINY IVORY
-  M5G > ARGENTO VENEZIA
VENETIAN SILVER
-  CRG > CROMO LUCIDO
POLISHED CHROME
-  T4G > BIANCO VINTAGE ARGENTO
WHITE VINTAGE SILVER

M70



			
96	129	29	20

P77
P88



			
P77	-	-	27 35
P88	-	-	24 30

-  R3G > ARGENTO NOTTINGHAM
NOTTINGHAM SILVER
-  F7G > VERNICIATO NICHEL SATINATO
VARNISHED NICKEL SATINED
-  E8G > ARGENTO VECCHIO BRILLANTE
SHINY OLD SILVER
-  T5G > AVORIO VINTAGE ORO
IVORY VINTAGE GOLD
-  GPG > PLACCATO ORO
GOLD PLATED
-  R4G > ORO ROMA
ROMA GOLD



-  R8G > ORO MILANO
MILANO GOLD
-  A8G > ORVAL
ORVAL
-  D1G > ANTICA FIRENZE
ANTIQUÉ FLORENCE
-  B1G > BRONZO COUNTRY
BRONZE COUNTRY
-  C1G > RAME ANTICO COUNTRY
ANTIQUÉ COPPER COUNTRY



COMBINAZIONI / MATCHING

M00.00.00.00 > MODELLO / MODEL
P00.00.00.00

M00.00.00.00 > SMALTO / GLAZE
P00.00.00.00

M00.00.00.00 > DECORO / ORNAMENT
P00.00.00.00

M00.00.00.00 > FINITURA / FINISHING
P00.00.00.00

ALTRE COMBINAZIONI DISPONIBILI PAG. 394-395
OTHER COMBINATIONS AVAILABLE PAGE 394-395



Linea Romantic

SERIE M71



GIUSTI



M71



⌀	↔	↑	↓
128	154	30	18

P77
P88



⌀	↔	↑	⊘
P77	-	-	27 35
P88	-	-	24 30

FINITURE / FINISHING

-  C2G > RUSTIKALL AVORIO
RUSTIKALL IVORY
-  M2G > LACCATO AVORIO LUCIDO
SHINY IVORY
-  M5G > ARGENTO VENEZIA
VENETIAN SILVER
-  CRG > CROMO LUCIDO
POLISHED CHROME
-  T4G > BIANCO VINTAGE ARGENTO
WHITE VINTAGE SILVER



M71.01.G9.GPG



M71.01.H3.R4G



M71.01.F5.D1G



M71.01.G4.A8G



P77.01.G9.GPG



P77.01.H3.R4G



P77.01.F5.D1G



P77.01.G4.A8G

-  R3G > ARGENTO NOTTINGHAM
NOTTINGHAM SILVER
-  F7G > VERNICIATO NICHEL SATINATO
VARNISHED NICKEL SATINED
-  E8G > ARGENTO VECCHIO BRILLANTE
SHINY OLD SILVER
-  T5G > AVORIO VINTAGE ORO
IVORY VINTAGE GOLD
-  GPG > PLACCATO ORO
GOLD PLATED
-  R4G > ORO ROMA
ROMA GOLD



M71.01.H5.E8G



M71.00.G3.T4G



M71.00.F7.CRG



P77.01.H5.E8G



P77.00.G3.T4G



P77.00.F7.CRG

-  R8G > ORO MILANO
MILANO GOLD
-  A8G > ORVAL
ORVAL
-  D1G > ANTICA FIRENZE
ANTIQUÉ FLORENCE
-  B1G > BRONZO COUNTRY
BRONZE COUNTRY
-  C1G > RAME ANTICO COUNTRY
ANTIQUÉ COPPER COUNTRY

COMBINAZIONI / MATCHING

M00.00.00.00 > MODELLO / MODEL
P00.00.00.00

M00.00.00.00 > SMALTO / GLAZE
P00.00.00.00

M00.00.00.00 > DECORO / ORNAMENT
P00.00.00.00

M00.00.00.00 > FINITURA / FINISHING
P00.00.00.00

ALTRE COMBINAZIONI DISPONIBILI PAG. 396-397
OTHER COMBINATIONS AVAILABLE PAGE 396-397



Linea
Romantic
SERIE M72
GIUSTI



FINITURE / FINISHING

-  C2G > RUSTIKALL AVORIO
RUSTIKALL IVORY
-  M2G > LACCATO AVORIO LUCIDO
SHINY IVORY
-  M5G > ARGENTO VENEZIA
VENETIAN SILVER
-  CRG > CROMO LUCIDO
POLISHED CHROME
-  T4G > BIANCO VINTAGE ARGENTO
WHITE VINTAGE SILVER





M72



			
128	158	31	26

P77
P88



			
P77	-	-	27 35
P88	-	-	24 30

-  R3G > ARGENTO NOTTINGHAM
NOTTINGHAM SILVER
-  F7G > VERNICIATO NICHEL SATINATO
VARNISHED NICKEL SATINED
-  E8G > ARGENTO VECCHIO BRILLANTE
SHINY OLD SILVER
-  T5G > AVORIO VINTAGE ORO
IVORY VINTAGE GOLD
-  GPG > PLACCATO ORO
GOLD PLATED
-  R4G > ORO ROMA
ROMA GOLD



M72.01.G6.D1G



M72.01.H3.A8G



M72.01.F3.GPG



M72.01.G7.T5G



P77.01.G6.D1G



P77.01.H3.A8G



P77.01.F3.GPG



P77.01.G7.T5G

-  R8G > ORO MILANO
MILANO GOLD
-  A8G > ORVAL
ORVAL
-  D1G > ANTICA FIRENZE
ANTIQUÉ FLORENCE
-  B1G > BRONZO COUNTRY
BRONZE COUNTRY
-  C1G > RAME ANTICO COUNTRY
ANTIQUÉ COPPER COUNTRY



M72.00.H4.R3G



M72.00.F7.M5G



M72.01.H5.C2G



P77.00.H4.R3G



P77.00.F7.M5G



P77.01.H5.C2G

COMBINAZIONI / MATCHING

M00.00.00.00 > MODELLO / MODEL
P00.00.00.00

M00.00.00.00 > SMALTO / GLAZE
P00.00.00.00

M00.00.00.00 > DECORO / ORNAMENT
P00.00.00.00

M00.00.00.00 > FINITURA / FINISHING
P00.00.00.00



Linea Romantic

SERIE M73



GIUSTI

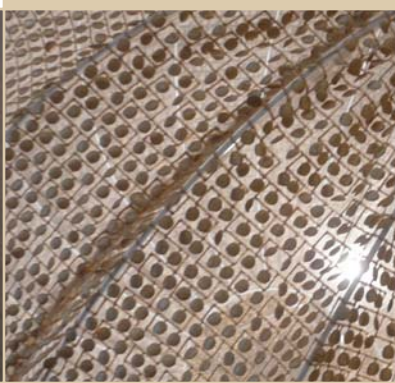

M73



96	125	29	24

P77
P88



P77	-	-	27 35
P88	-	-	24 30

FINITURE / FINISHING

- C2G > RUSTIKALL AVORIO
RUSTIKALL IVORY
- M2G > LACCATO AVORIO LUCIDO
SHINY IVORY
- M5G > ARGENTO VENEZIA
VENETIAN SILVER
- CRG > CROMO LUCIDO
POLISHED CHROME
- T4G > BIANCO VINTAGE ARGENTO
WHITE VINTAGE SILVER



M73.01.F8.R3G



M73.01.G2.A8G



M73.01.H5.D1G



M73.01.H7.C1G



P77.01.F8.R3G



P77.01.G2.A8G



P77.01.H5.D1G



P77.01.H7.C1G

- R3G > ARGENTO NOTTINGHAM
NOTTINGHAM SILVER
- F7G > VERNICIATO NICHEL SATINATO
VARNISHED NICKEL SATINED
- E8G > ARGENTO VECCHIO BRILLANTE
SHINY OLD SILVER
- T5G > AVORIO VINTAGE ORO
IVORY VINTAGE GOLD
- GPG > PLACCATO ORO
GOLD PLATED
- R4G > ORO ROMA
ROMA GOLD

COMBINAZIONI / MATCHING

M00.00.00.00 > MODELLO / MODEL
P00.00.00.00

M00.00.00.00 > SMALTO / GLAZE
P00.00.00.00

M00.00.00.00 > DECORO / ORNAMENT
P00.00.00.00

M00.00.00.00 > FINITURA / FINISHING
P00.00.00.00



M73.00.H4.T4G



M73.01.G4.M2G



M73.00.F2.CRG



P77.00.H4.T4G



P77.01.G4.M2G



P77.00.F2.CRG

- R8G > ORO MILANO
MILANO GOLD
- A8G > ORVAL
ORVAL
- D1G > ANTICA FIRENZE
ANTIQUÉ FLORENCE
- B1G > BRONZO COUNTRY
BRONZE COUNTRY
- C1G > RAME ANTICO COUNTRY
ANTIQUÉ COPPER COUNTRY

ALTRE COMBINAZIONI DISPONIBILI PAG. 400-401
OTHER COMBINATIONS AVAILABLE PAGE 400-401



Linea Romantic

SERIE M74



GIUSTI







FINITURE / FINISHING

-  C2G > RUSTIKALL AVORIO
RUSTIKALL IVORY
-  M2G > LACCATO AVORIO LUCIDO
SHINY IVORY
-  M5G > ARGENTO VENEZIA
VENETIAN SILVER
-  CRG > CROMO LUCIDO
POLISHED CHROME
-  T4G > BIANCO VINTAGE ARGENTO
WHITE VINTAGE SILVER

M74



			
128	154	33	22

P77
P88



				
P77	-	-	27	35
P88	-	-	24	30

-  R3G > ARGENTO NOTTINGHAM
NOTTINGHAM SILVER
-  F7G > VERNICIATO NICHEL SATINATO
VARNISHED NICKEL SATINED
-  E8G > ARGENTO VECCHIO BRILLANTE
SHINY OLD SILVER
-  T5G > AVORIO VINTAGE ORO
IVORY VINTAGE GOLD
-  GPG > PLACCATO ORO
GOLD PLATED
-  R4G > ORO ROMA
ROMA GOLD



M74.01.G7.R4G



M74.01.F8.A8G



M74.01.H3.D1G



M74.01.G6.B1G



P77.01.G7.R4G



P77.01.F8.A8G



P77.01.H3.D1G



P77.01.G6.B1G

-  R8G > ORO MILANO
MILANO GOLD
-  A8G > ORVAL
ORVAL
-  D1G > ANTICA FIRENZE
ANTIQUÉ FLORENCE
-  B1G > BRONZO COUNTRY
BRONZE COUNTRY
-  C1G > RAME ANTICO COUNTRY
ANTIQUÉ COPPER COUNTRY



M74.01.H5.C2G



M74.00.H4.E8G



M74.00.G8.R3G



P77.01.H5.C2G



P77.00.H4.E8G



P77.00.G8.R3G

COMBINAZIONI / MATCHING

M00.00.00.00 > MODELLO / MODEL
P00.00.00.00

M00.00.00.00 > SMALTO / GLAZE
P00.00.00.00

M00.00.00.00 > DECORO / ORNAMENT
P00.00.00.00

M00.00.00.00 > FINITURA / FINISHING
P00.00.00.00

ALTRE COMBINAZIONI DISPONIBILI PAG. 402-403
OTHER COMBINATIONS AVAILABLE PAGE 402-403



Linea Romantic

SERIE M75



GIUSTI



M75



96	122	31	20

P77
P88



P77	-	27	35
P88	-	24	30

FINITURE / FINISHING

- C2G > RUSTIKALL AVORIO
RUSTIKALL IVORY
- M2G > LACCATO AVORIO LUCIDO
SHINY IVORY
- M5G > ARGENTO VENEZIA
VENETIAN SILVER
- CRG > CROMO LUCIDO
POLISHED CHROME
- T4G > BIANCO VINTAGE ARGENTO
WHITE VINTAGE SILVER



M75.01.F6.GPG



M75.01.F1.A8G



M75.01.H2.D1G



M75.01.H5.T5G



P77.01.F6.GPG



P77.01.F1.A8G



P77.01.H2.D1G



P77.01.H5.T5G

- R3G > ARGENTO NOTTINGHAM
NOTTINGHAM SILVER
- F7G > VERNICIATO NICHEL SATINATO
VARNISHED NICKEL SATINED
- E8G > ARGENTO VECCHIO BRILLANTE
SHINY OLD SILVER
- T5G > AVORIO VINTAGE ORO
IVORY VINTAGE GOLD
- GPG > PLACCATO ORO
GOLD PLATED
- R4G > ORO ROMA
ROMA GOLD

COMBINAZIONI / MATCHING

M00.00.00.00 > MODELLO / MODEL
P00.00.00.00

M00.00.00.00 > SMALTO / GLAZE
P00.00.00.00

M00.00.00.00 > DECORO / ORNAMENT
P00.00.00.00

M00.00.00.00 > FINITURA / FINISHING
P00.00.00.00



M75.01.G1.C1G



M75.01.G9.C2G



M75.00.G3.M5G



P77.01.G1.C1G



P77.01.G9.C2G



P77.00.G3.M5G

- R8G > ORO MILANO
MILANO GOLD
- A8G > ORVAL
ORVAL
- D1G > ANTICA FIRENZE
ANTIQUA FLORENCE
- B1G > BRONZO COUNTRY
BRONZE COUNTRY
- C1G > RAME ANTICO COUNTRY
ANTIQUA COPPER COUNTRY

ALTRE COMBINAZIONI DISPONIBILI PAG. 404-405
OTHER COMBINATIONS AVAILABLE PAGE 404-405



Linea Romantic

SERIE M76



GIUSTI







FINITURE / FINISHING

-  C2G > RUSTIKALL AVORIO
RUSTIKALL IVORY
-  M2G > LACCATO AVORIO LUCIDO
SHINY IVORY
-  M5G > ARGENTO VENEZIA
VENETIAN SILVER
-  CRG > CROMO LUCIDO
POLISHED CHROME
-  T4G > BIANCO VINTAGE ARGENTO
WHITE VINTAGE SILVER

M76



			
128	159	36	25

P77
P88



			
P77	-	-	27 35
P88	-	-	24 30

-  R3G > ARGENTO NOTTINGHAM
NOTTINGHAM SILVER
-  F7G > VERNICIATO NICHEL SATINATO
VARNISHED NICKEL SATINED
-  E8G > ARGENTO VECCHIO BRILLANTE
SHINY OLD SILVER
-  T5G > AVORIO VINTAGE ORO
IVORY VINTAGE GOLD
-  GPG > PLACCATO ORO
GOLD PLATED
-  R4G > ORO ROMA
ROMA GOLD



M76.01.F8.R4G



M76.01.H3.A8G



M76.01.H7.D1G



M76.01.G9.C1G



P77.01.F8.R4G



P77.01.H3.A8G



P77.01.H7.D1G



P77.01.G9.C1G

-  R8G > ORO MILANO
MILANO GOLD
-  A8G > ORVAL
ORVAL
-  D1G > ANTICA FIRENZE
ANTIQUÉ FLORENCE
-  B1G > BRONZO COUNTRY
BRONZE COUNTRY
-  C1G > RAME ANTICO COUNTRY
ANTIQUÉ COPPER COUNTRY



M76.01.F3.C2G



M76.01.H2.E8G



M76.00.H4.CRG



P77.01.F3.C2G



P77.01.H2.E8G



P77.00.H4.CRG

COMBINAZIONI / MATCHING

M00.00.00.00 > MODELLO / MODEL
P00.00.00.00

M00.00.00.00 > SMALTO / GLAZE
P00.00.00.00

M00.00.00.00 > DECORO / ORNAMENT
P00.00.00.00

M00.00.00.00 > FINITURA / FINISHING
P00.00.00.00

ALTRE COMBINAZIONI DISPONIBILI PAG. 406-407
OTHER COMBINATIONS AVAILABLE PAGE 406-407



Linea Romantic

SERIE M77



GIUSTI



M77



96	127	36	26

P77
P88



P77	-	27	35
P88	-	24	30

FINITURE / FINISHING

- C2G > RUSTIKALL AVORIO
RUSTIKALL IVORY
- M2G > LACCATO AVORIO LUCIDO
SHINY IVORY
- M5G > ARGENTO VENEZIA
VENETIAN SILVER
- CRG > CROMO LUCIDO
POLISHED CHROME
- T4G > BIANCO VINTAGE ARGENTO
WHITE VINTAGE SILVER

- M77.01.H5.GPG
- M77.01.G7.A8G
- M77.01.H3.D1G
- M77.01.F5.T5G

- P77.01.H5.GPG
- P77.01.G7.A8G
- P77.01.H3.D1G
- P77.01.F5.T5G

- R3G > ARGENTO NOTTINGHAM
NOTTINGHAM SILVER
- F7G > VERNICIATO NICHEL SATINATO
VARNISHED NICKEL SATINED
- E8G > ARGENTO VECCHIO BRILLANTE
SHINY OLD SILVER
- T5G > AVORIO VINTAGE ORO
IVORY VINTAGE GOLD
- GPG > PLACCATO ORO
GOLD PLATED
- R4G > ORO ROMA
ROMA GOLD

COMBINAZIONI / MATCHING

M00.00.00.00 > MODELLO / MODEL
P00.00.00.00

M00.00.00.00 > SMALTO / GLAZE
P00.00.00.00

M00.00.00.00 > DECORO / ORNAMENT
P00.00.00.00

M00.00.00.00 > FINITURA / FINISHING
P00.00.00.00

- M77.00.G3.E8G
- M77.01.G9.R3G
- M77.01.H2.M5G

- P77.00.G3.E8G
- P77.01.G9.R3G
- P77.01.H2.M5G

- R8G > ORO MILANO
MILANO GOLD
- A8G > ORVAL
ORVAL
- D1G > ANTICA FIRENZE
ANTIQUA FLORENCE
- B1G > BRONZO COUNTRY
BRONZE COUNTRY
- C1G > RAME ANTICO COUNTRY
ANTIQUA COPPER COUNTRY

ALTRE COMBINAZIONI DISPONIBILI PAG. 408-409
OTHER COMBINATIONS AVAILABLE PAGE 408-409



Linea Romantic

SERIE M78



GIUSTI







FINITURE / FINISHING

-  C2G > RUSTIKALL AVORIO
RUSTIKALL IVORY
-  M2G > LACCATO AVORIO LUCIDO
SHINY IVORY
-  M5G > ARGENTO VENEZIA
VENETIAN SILVER
-  CRG > CROMO LUCIDO
POLISHED CHROME
-  T4G > BIANCO VINTAGE ARGENTO
WHITE VINTAGE SILVER

M78



			
128	148	32	28

P77
P88



			
P77	-	-	27 35
P88	-	-	24 30

-  R3G > ARGENTO NOTTINGHAM
NOTTINGHAM SILVER
-  F7G > VERNICIATO NICHEL SATINATO
VARNISHED NICKEL SATINED
-  E8G > ARGENTO VECCHIO BRILLANTE
SHINY OLD SILVER
-  T5G > AVORIO VINTAGE ORO
IVORY VINTAGE GOLD
-  GPG > PLACCATO ORO
GOLD PLATED
-  R4G > ORO ROMA
ROMA GOLD



M78.01.G9.R4G



M78.01.G7.A8G



M78.01.H5.D1G



M78.01.G6.T5G



P77.01.G9.R4G



P77.01.G7.A8G



P77.01.H5.D1G



P77.01.G6.T5G

-  R8G > ORO MILANO
MILANO GOLD
-  A8G > ORVAL
ORVAL
-  D1G > ANTICA FIRENZE
ANTIQUÉ FLORENCE
-  B1G > BRONZO COUNTRY
BRONZE COUNTRY
-  C1G > RAME ANTICO COUNTRY
ANTIQUÉ COPPER COUNTRY



M78.01.G4.C2G



M78.01.F8.E8G



M78.00.H4.R3G



P77.01.G4.C2G



P77.01.F8.E8G



P77.00.H4.R3G

COMBINAZIONI / MATCHING

M00.00.00.00 > MODELLO / MODEL
P00.00.00.00

M00.00.00.00 > SMALTO / GLAZE
P00.00.00.00

M00.00.00.00 > DECORO / ORNAMENT
P00.00.00.00

M00.00.00.00 > FINITURA / FINISHING
P00.00.00.00

ALTRE COMBINAZIONI DISPONIBILI PAG. 410-411
OTHER COMBINATIONS AVAILABLE PAGE 410-411



Linea Romantic

SERIE M80



GIUSTI



M80



⊕	↔	↑	↓
96	126	31	18

P77
P88



⊕	↔	↑	⊙
P77	-	-	27 35
P88	-	-	24 30

FINITURE / FINISHING

-  C2G > RUSTIKALL AVORIO
RUSTIKALL IVORY
-  M2G > LACCATO AVORIO LUCIDO
SHINY IVORY
-  M5G > ARGENTO VENEZIA
VENETIAN SILVER
-  CRG > CROMO LUCIDO
POLISHED CHROME
-  T4G > BIANCO VINTAGE ARGENTO
WHITE VINTAGE SILVER



M80.01.H3.A8G



M80.01.F3.D1G



M80.01.H2.T5G



M80.01.G1.C1G



P77.01.H3.A8G



P77.01.F3.D1G



P77.01.H2.T5G



P77.01.G1.C1G

-  R3G > ARGENTO NOTTINGHAM
NOTTINGHAM SILVER
-  F7G > VERNICIATO NICHEL SATINATO
VARNISHED NICKEL SATINED
-  E8G > ARGENTO VECCHIO BRILLANTE
SHINY OLD SILVER
-  T5G > AVORIO VINTAGE ORO
IVORY VINTAGE GOLD
-  GPG > PLACCATO ORO
GOLD PLATED
-  R4G > ORO ROMA
ROMA GOLD



M80.01.H5.C2G



M80.00.H4.E8G



M80.00.G8.R3G



P77.01.H5.C2G



P77.00.H4.E8G



P77.00.G8.R3G

-  R8G > ORO MILANO
MILANO GOLD
-  A8G > ORVAL
ORVAL
-  D1G > ANTICA FIRENZE
ANTIQUÉ FLORENCE
-  B1G > BRONZO COUNTRY
BRONZE COUNTRY
-  C1G > RAME ANTICO COUNTRY
ANTIQUÉ COPPER COUNTRY

COMBINAZIONI / MATCHING

M00.00.00.00 > MODELLO / MODEL
P00.00.00.00

M00.00.00.00 > SMALTO / GLAZE
P00.00.00.00

M00.00.00.00 > DECORO / ORNAMENT
P00.00.00.00

M00.00.00.00 > FINITURA / FINISHING
P00.00.00.00

ALTRE COMBINAZIONI DISPONIBILI PAG. 412-413
OTHER COMBINATIONS AVAILABLE PAGE 412-413



Linea Romantic

SERIE M81



GIUSTI







FINITURE / FINISHING

-  C2G > RUSTIKALL AVORIO
RUSTIKALL IVORY
-  M2G > LACCATO AVORIO LUCIDO
SHINY IVORY
-  M5G > ARGENTO VENEZIA
VENETIAN SILVER
-  CRG > CROMO LUCIDO
POLISHED CHROME
-  T4G > BIANCO VINTAGE ARGENTO
WHITE VINTAGE SILVER

M81



			
96	140	29	22

P77
P88



			
P77	-	-	27 35
P88	-	-	24 30

-  R3G > ARGENTO NOTTINGHAM
NOTTINGHAM SILVER
-  F7G > VERNICIATO NICHEL SATINATO
VARNISHED NICKEL SATINED
-  E8G > ARGENTO VECCHIO BRILLANTE
SHINY OLD SILVER
-  T5G > AVORIO VINTAGE ORO
IVORY VINTAGE GOLD
-  GPG > PLACCATO ORO
GOLD PLATED
-  R4G > ORO ROMA
ROMA GOLD



-  R8G > ORO MILANO
MILANO GOLD
-  A8G > ORVAL
ORVAL
-  D1G > ANTICA FIRENZE
ANTIQUE FLORENCE
-  B1G > BRONZO COUNTRY
BRONZE COUNTRY
-  C1G > RAME ANTICO COUNTRY
ANTIQUE COPPER COUNTRY



COMBINAZIONI / MATCHING

M00.00.00.00 > MODELLO / MODEL
P00.00.00.00

M00.00.00.00 > SMALTO / GLAZE
P00.00.00.00

M00.00.00.00 > DECORO / ORNAMENT
P00.00.00.00

M00.00.00.00 > FINITURA / FINISHING
P00.00.00.00

ALTRE COMBINAZIONI DISPONIBILI PAG. 414-415
OTHER COMBINATIONS AVAILABLE PAGE 414-415

Linea Romantic

SERIE P77 - P88



GIUSTI



P77



-	-	27	35

P88



-	-	24	30

FINITURE / FINISHING

- C2G > RUSTIKALL AVORIO
RUSTIKALL IVORY
- M2G > LACCATO AVORIO LUCIDO
SHINY IVORY
- M5G > ARGENTO VENEZIA
VENETIAN SILVER
- CRG > CROMO LUCIDO
POLISHED CHROME
- T4G > BIANCO VINTAGE ARGENTO
WHITE VINTAGE SILVER

ALTRE COMBINAZIONI DISPONIBILI OTHER COMBINATIONS AVAILABLE

- P77.01.G7.GPG
- P77.01.G2.R4G
- P77.01.H2.D1G
- P77.01.F8.C1G

- P88.01.G7.GPG
- P88.01.G2.R4G
- P88.01.H2.D1G
- P88.01.F8.C1G

- R3G > ARGENTO NOTTINGHAM
NOTTINGHAM SILVER
- F7G > VERNICIATO NICHEL SATINATO
VARNISHED NICKEL SATINED
- E8G > ARGENTO VECCHIO BRILLANTE
SHINY OLD SILVER
- T5G > AVORIO VINTAGE ORO
IVORY VINTAGE GOLD
- GPG > PLACCATO ORO
GOLD PLATED
- R4G > ORO ROMA
ROMA GOLD

COMBINAZIONI / MATCHING

M00.00.00.00 > MODELLO / MODEL
P00.00.00.00

M00.00.00.00 > SMALTO / GLAZE
P00.00.00.00

M00.00.00.00 > DECORO / ORNAMENT
P00.00.00.00

M00.00.00.00 > FINITURA / FINISHING
P00.00.00.00

- P77.00.F7.CRG
- P77.01.H5.R3G
- P77.00.H4.E8G
- P77.01.F3.C2G

- P88.00.F7.CRG
- P88.01.H5.R3G
- P88.00.H4.E8G
- P88.01.F3.C2G

- R8G > ORO MILANO
MILANO GOLD
- A8G > ORVAL
ORVAL
- D1G > ANTICA FIRENZE
ANTIQUÉ FLORENCE
- B1G > BRONZO COUNTRY
BRONZE COUNTRY
- C1G > RAME ANTICO COUNTRY
ANTIQUÉ COPPER COUNTRY





Romantic

Customize

Crea la tua maniglia ed abbinla il pomolo / Customize your handle and match your knob



PERSONALIZZA LA TUA MANIGLIA CUSTOMIZE YOUR HANDLE

01



M54.01.81.D1G

SCEGLI IL MODELLO / CHOOSE YOUR MODEL

02



M54.01.81.D1G

SCEGLI IL COLORE DELLA PORCELLANA / CHOOSE PORCELAIN GLAZE COLOUR

03



M54.01.81.D1G

SCEGLI IL DECORO / CHOOSE ORNAMENT

04



M54.01.81.D1G

SCEGLI LA FINITURA DEL METALLO / CHOOSE METAL FINISHING



M54.01.81.D1G

ECCO FORMATO IL TUO CODICE ARTICOLO / HERE YOU HAVE YOUR CODE ITEM

PERSONALIZZA IL TUO POMOLO CUSTOMIZE YOUR KNOB

01

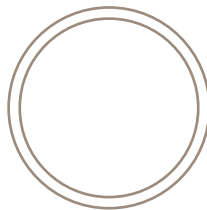

P07.01.81.D1G

SCEGLI IL MODELLO / CHOOSE YOUR MODEL

02



P07.01.81.D1G

SCEGLI IL COLORE DELLA PORCELLANA / CHOOSE PORCELAIN COLOUR

03



P07.01.81.D1G

SCEGLI IL DECORO / CHOOSE ORNAMENT

04



P07.01.81.D1G

SCEGLI LA FINITURA DEL METALLO / CHOOSE METAL FINISHING



P07.01.81.D1G

ECCO FORMATO IL TUO CODICE ARTICOLO / HERE YOU HAVE YOUR CODE ITEM

01

MANIGLIE HANDLES

CODE M01

96	107	27	18

M01.00.00.00G



CODE M07

96	106	31	18

M07.00.00.00G



CODE M09

96	126	31	23

M09.00.00.00G



CODE M50

96	124	29	20

M50.00.00.00G



CODE M11

96	123	28	28

M11.00.00.00G



MANIGLIE HANDLES

01



CODE M12

128	146	30	20

M12.00.00.00G



CODE M16

96	136	32	30

M16.00.00.00G



CODE M17

96*	142	28	18

M17.00.00.00G

* doppio interasse 96 -128
dual centres 96-128



CODE M19

96	107	29	18

M19.00.00.00G



CODE M21

96	134	33	26

M21.00.00.00G

01

MANIGLIE HANDLES

CODE M22

96	129	29	18

M22.00.00.00G



CODE M24

96	116	34	24

M24.00.00.00G

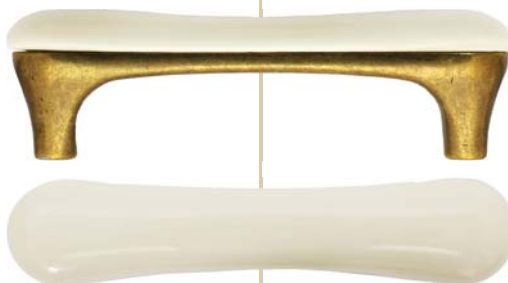

CODE M25

96	106	(14)	54

M25.00.00.00G



CODE M26

128	147	29	24

M26.00.00.00G



CODE M27

96	118	30	24

M27.00.00.00G



MANIGLIE HANDLES

01



CODE M28

⊕ ⊕	↔	↑	↓
96	114	26	22

M28.00.00.00G



CODE M53

⊕ ⊕	↔	↑	↓
128	146	26	25

M53.00.00.00G



CODE M10

⊕ ⊕	↔	↑	↓
96	125	30	20

M10.00.00.00G



CODE M54

⊕ ⊕	↔	↑	↓
128	160	31	23

M54.00.00.00G



CODE M51

⊕ ⊕	↔	↑	↓
96	122	29	18

M51.00.00.00G

01

MANIGLIE HANDLES

CODE M55

128	145	32	26

M55.00.00.00G



CODE M56

128	150	30	20

M56.00.00.00G



* M56.00.00.00G = M56.XX.00.00G

CODE M62

96	112	33	16

M62.00.00.00G



CODE M63

32	107	29	35

M63.00.00.00G



CODE M70

96	129	29	20

M70.00.00.00G



MANIGLIE HANDLES

01

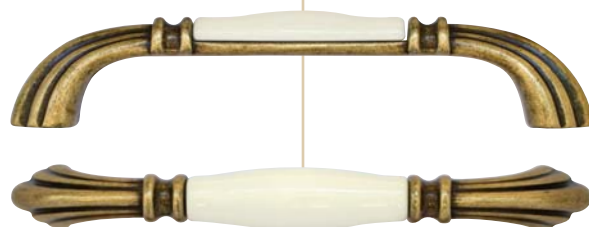

CODE M71

⊕ ⊕	↔	↑	↓
128	154	30	18

M71.00.00.00G



CODE M72

⊕ ⊕	↔	↑	↓
128	158	31	26

M72.00.00.00G



CODE M73

⊕ ⊕	↔	↑	↓
96	125	29	24

M73.00.00.00G



CODE M74

⊕ ⊕	↔	↑	↓
128	154	33	22

M74.00.00.00G



CODE M75

⊕ ⊕	↔	↑	↓
96	122	31	20

M75.00.00.00G

01

MANIGLIE HANDLES

CODE M76

128	159	36	25

M76.00.00.00G



CODE M77

96	127	36	26

M77.00.00.00G



CODE M78

128	148	32	28

M78.00.00.00G



CODE M80

96	126	31	18

M80.00.00.00G

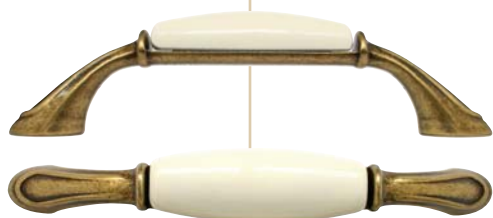

CODE M81

96	140	29	22

M81.00.00.00G



POMOLI KNOBS

01



CODE P01

-	43	34	25

P01.00.00.00G



CODE P02

-	34	25	24

P02.00.00.00G



CODE P03

-	35	30	35

P03.00.00.00G



CODE P04

-	31	26	31

P04.00.00.00G



CODE P05

-	28	27	28

P05.00.00.00G

01

POMOLI KNOBS

CODE P06

-	21	21	21

P06.00.00.00G



CODE P14

-	44	36	44

P14.00.00.00G



CODE P07

-	34	25	34

P07.00.00.00G



CODE P08

-	29	24	29

P08.00.00.00G



CODE P09

-	24	22	24

P09.00.00.00G



POMOLI KNOBS

01



CODE P10

⌀	↔	↑	⊘
-	36	31	36

P10.00.00.00G



CODE P11

⌀	↔	↑	⊘
-	31	29	31

P11.00.00.00G



CODE P16

⌀	↔	↑	↓
-	27	30	67

P16.00.00.00G



CODE P17

⌀	↔	↑	⊘
-	38	28	38

P17.00.00.00G



CODE P18

⌀	↔	↑	↓
-	58	25	34

P18.00.00.00G

01

POMOLI KNOBS

CODE PN1

-	22	22	60

PN1.00.00.00G



CODE P20

16	35	29	35

P20.00.00.00G



CODE P23

-	55	34	55

P23.00.00.00G



CODE P77

-	-	27	35

P77.00.00.00G



CODE P88

-	-	24	30

P88.00.00.00G



**SMALTO
GLAZE**

02



CODE 00
M00.00.00.00G
SMALTO BIANCO / WHITE GLAZE

CODE 01
M00.01.00.00G
SMALTO AVORIO / IVORY GLAZE



CODE 02
M00.02.00.00G
SMALTO GRESS / GRESS GLAZE

CODE 10
M00.10.00.00G
SMALTO PIETRA / STONE GLAZE



CODE 20
M00.20.00.00G
SMALTO BIANCO MATT / MATT WHITE GLAZE

CODE 21
M00.21.00.00G
SMALTO ROSSO MATT / MATT RED GLAZE

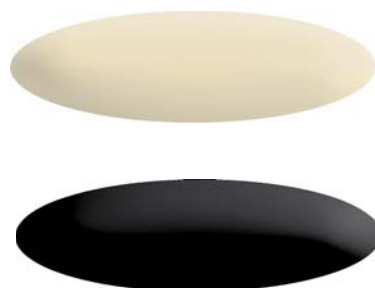

CODE 22
M00.22.00.00G
SMALTO CREMA / CREAM GLAZE

CODE 23
M00.23.00.00G
SMALTO NERO MATT / MATT BLACK GLAZE



CODE 07
M00.07.00.00G
SMALTO NERO LUCIDO / SHINY BLACK GLAZE

CODE 30
M00.30.00.00G
MADREPERLA / MOTHER OF PEARL GLAZE

03

DECORI ORNAMENT

CODE 01
M00.00.01.00G



CODE 02
M00.00.02.00G



CODE 03
M00.00.03.00G



CODE 04
M00.00.04.00G



CODE 05
M00.00.05.00G



CODE 08
M00.00.08.00G



CODE 10
M00.00.10.00G



CODE 11
M00.00.11.00G



CODE 12
M00.00.12.00G



CODE 20
M00.00.20.00G



**DECORI
ORNAMENT**

03



CODE 21
M00.00.21.00G
OCRA / OCHRE

CODE 22
M00.00.22.00G
ORO / GOLD



CODE 25
M00.00.25.00G

CODE 51
M00.00.51.00G
OCRA / OCHRE



CODE 62
M00.00.62.00G

CODE 68
M00.00.68.00G
OCRA / OCHRE



CODE 71
M00.00.71.00G

CODE 77
M00.00.77.00G



CODE 81
M00.00.81.00G

CODE 84
M00.00.84.00G

03

DECORI ORNAMENT

CODE 85
M00.00.85.00G



CODE 90
M00.00.90.00G



CODE 91
M00.00.91.00G



CODE 113
M00.00.113.00G



CODE 115
M00.00.115.00G



CODE 120
M00.00.120.00G



CODE 124
M00.00.124.00G



CODE A1
M00.00.A1.00G
ORO / GOLD



CODE A2
M00.00.A2.00G
ARGENTO / SILVER



CODE A4
M00.00.A4.00G
MARRONE / BROWN



DECORI ORNAMENT

03



CODE A5
M00.00.A5.00G
ORO / GOLD



CODE A6
M00.00.A6.00G
ARGENTO / SILVER



CODE A7
M00.00.A7.00G
MARRONE / BROWN



CODE A8
M00.00.A8.00G
ORO / GOLD



CODE A9
M00.00.A9.00G
ARGENTO / SILVER



CODE B1
M00.00.B1.00G
MARRONE / BROWN



CODE B2
M00.00.B2.00G
ORO / GOLD



CODE B3
M00.00.B3.00G
ARGENTO / SILVER



CODE B4
M00.00.B4.00G
ORO / GOLD



CODE B5
M00.00.B5.00G

03

DECORI ORNAMENT

CODE F1
M00.00.F1.00G
ORO / GOLD



CODE F2
M00.00.F2.00G
ARGENTO / SILVER



CODE F3
M00.00.F3.00G
BIANCO / WHITE



CODE F5
M00.00.F5.00G
MARRONE / BROWN



CODE F6
M00.00.F6.00G
ORO / GOLD



CODE F7
M00.00.F7.00G
ARGENTO / SILVER



CODE F8
M00.00.F8.00G
BIANCO / WHITE



CODE G1
M00.00.G1.00G
MARRONE / BROWN



CODE G2
M00.00.G2.00G
ORO / GOLD



CODE G3
M00.00.G3.00G
ARGENTO / SILVER



DECORI ORNAMENT

03



CODE G4
M00.00.G4.00G
BIANCO / WHITE

CODE G6
M00.00.G6.00G
MARRONE / BROWN



CODE G7
M00.00.G7.00G
ORO / GOLD

CODE G8
M00.00.G8.00G
ARGENTO / SILVER



CODE G9
M00.00.G9.00G
BIANCO / WHITE

CODE H2
M00.00.H2.00G
MARRONE / BROWN



CODE H3
M00.00.H3.00G
ORO / GOLD

CODE H4
M00.00.H4.00G
ARGENTO / SILVER



CODE H5
M00.00.H5.00G
BIANCO / WHITE

CODE H7
M00.00.H7.00G
MARRONE / BROWN

04

FINITURE FINISHES

CODE F7G

M00.00.00.F7G

VERNICIATO NICHEL SATINATO
VARNISHED NICKEL SATINED



CODE CRG

M00.00.00.CRG

CROMO LUCIDO
POLISHED CHROME



CODE M5G

M00.00.00.M5G

ARGENTO VENEZIA
VENETIAN SILVER



CODE 15G

M00.00.00.15G

ARGENTO VECCHIO (*)
OLD SILVER



CODE E8G

M00.00.00.E8G

ARGENTO VECCHIO BRILLANTE
SHINY OLD SILVER



CODE R3G

M00.00.00.R3G

ARGENTO NOTTINGHAM
NOTTINGHAM SILVER



CODE 24G

M00.00.00.24G

NICHEL VECCHIO
OLD NICKEL



CODE B9G

M00.00.00.B9G

NICHEL VECCHIO COUNTRY
OLD NICKEL COUNTRY



CODE T4G

M00.00.00.T4G

BIANCO VINTAGE ARGENTO
WHITE VINTAGE SILVER



CODE 20G

M00.00.00.20G

FORGIA ANTICA
ANTIQUE FORGE



CODE D2G

M00.00.00.D2G

GRIGIO MADREPERLA
GRAY MOTHER OF PEARL



CODE M1G

M00.00.00.M1G

NICHEL LUCIDO
POLISHED NICKEL



(*) CONSIGLIATO / SUGGESTED

CODE S5G

M00.00.00.S5G

BIANCO GESSO
CHALK WHITE



CODE N3G

M00.00.00.N3G

LACCATO BIANCO MATT
VARNISHED WHITE MATT



CODE M2G

M00.00.00.M2G

LACCATO AVORIO LUCIDO
SHINY IVORY



FINITURE FINISHES

04

CODE T5G
M00.00.00.T5G
AVORIO VINTAGE ORO
IVORY VINTAGE GOLD

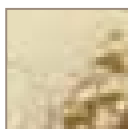

CODE GPG
M00.00.00.GPG
PLACCATO ORO
GOLD PLATED



CODE X4G
M00.00.00.X4G
BRONZO PARIGI
BRONZE PARIS



CODE R8G
M00.00.00.R8G
ORO MILANO
MILANO GOLD



CODE A8G
M00.00.00.A8G
ORVAL
ORVAL



CODE 80G
M00.00.00.80G
ANTICA ROMA
ANTIQUE ROME



CODE R4G
M00.00.00.R4G
ORO ROMA
ROMA GOLD



CODE D1G
M00.00.00.D1G
ANTICA FIRENZE (*)
ANTIQUE FLORENCE



CODE 01G
M00.00.00.01G
PATINATO
PATINATED



CODE 04G
M00.00.00.04G
BRONZO LUCIDO
POLISHED BRONZE



CODE A9G
M00.00.00.A9G
PATINATO COUNTRY
PATINATED COUNTRY



CODE B1G
M00.00.00.B1G
BRONZO COUNTRY (*)
BRONZO COUNTRY



CODE C1G
M00.00.00.C1G
RAME ANTICO COUNTRY (*)
ANTIQUE COPPER COUNTRY



CODE 27G
M00.00.00.27G
RAME ANTICO
ANTIQUE COPPER



CODE C2G
M00.00.00.C2G
RUSTIKALL AVORIO (*)
RUSTIKALL IVORY



(*) CONSIGLIATO / SUGGESTED





Romantic Best Sellers

Le personalizzazioni più richieste / Best Sellers customize items



Linea Romantic

SERIE M54



M54.01.A4.D1G



M54.01.A4.15G



M54.01.A4.C1G



M54.01.00.D1G



M54.01.00.15G



M54.01.00.C1G



M54.01.00.C2G



M54.01.12.D1G



M54.01.12.15G



M54.01.90.D1G



M54.01.90.15G



M54.01.113.D1G



128	160	31	23

M54.00.00.00G



POMOLI ABBINABILI PAG. 339-340-341-342
 KNOBS TO MATCH PAGES 339-340-341-342



M54.01.113.15G



M54.01.113.C1G



M54.01.113.C2G



M54.01.B1.D1G



M54.01.B1.15G



M54.02.B1.C2G



M54.01.81.D1G



M54.01.81.15G



M54.01.81.C1G



M54.01.81.C2G



M54.01.115.D1G



M54.01.115.15G

Linea Romantic

SERIE M54



M54.00.00.00G

128	160	31	23



POMOLI ABBINABILI PAG. 339-340-341-342
KNOBS TO MATCH PAGES 339-340-341-342

Linea Romantic

SERIE M54



M54.01.91.D1G



M54.01.91.15G



M54.01.01.D1G



M54.01.01.15G



M54.01.A7.D1G



M54.01.A7.15G



M54.01.A7.C1G



M54.02.A7.C2G



M54.01.25.15G



M54.01.A1.D1G



M54.01.A5.D1G



M54.01.B4.D1G



128	160	31	23

M54.00.00.00G



POMOLI ABBINABILI PAG. 339-340-341-342
 KNOBS TO MATCH PAGES 339-340-341-342



M54.01.04.D1G



M54.01.04.15G



M54.01.02.D1G



M54.01.02.15G



M54.02.00.D1G



M54.02.00.15G



M54.02.00.C2G



M54.10.00.D1G



M54.10.00.15G



M54.10.00.C1G



M54.10.00.C2G



M54.21.A5.D1G

Linea Romantic

SERIE M54



M54.00.00.00G

128	160	31	23



POMOLI ABBINABILI PAG. 339-340-341-342
KNOBS TO MATCH PAGES 339-340-341-342

Linea Romantic

SERIE M10



M10.01.00.D1G



M10.01.00.15G



M10.01.00.C2G



M10.01.12.C1G



M10.01.12.C2G



M10.01.90.15G



M10.01.81.D1G



M10.02.113.15G



M10.02.00.C1G



M10.02.68.C1G



M10.02.25.C2G



M10.01.A4.D1G



96	125	30	20

M10.00.00.00G



POMOLI ABBINABILI PAG. 339-340-341-342
KNOBS TO MATCH PAGES 339-340-341-342



M10.01.02.D1G



M10.01.02.15G



M10.01.B1.15G



M10.01.B1.C1G



M10.01.B1.C2G



M10.01.B4.D1G



M10.01.A1.D1G



M10.01.115.15G



M10.01.115.C1G



M10.10.00.D1G



M10.10.00.B1G



M10.21.A5.D1G

Linea Romantic

SERIE M10



M10.00.00.00G

96	125	30	20



POMOLI ABBINABILI PAG. 339-340-341-342
KNOBS TO MATCH PAGES 339-340-341-342

Linea Romantic

SERIE M01



M01.01.00.D1G



M01.01.00.15G



M01.01.00.C1G



M01.01.00.B1G



M01.01.00.C2G



M01.01.81.D1G



M01.01.81.C1G



M01.01.81.C2G



M01.01.91.D1G



M01.01.01.D1G



M01.02.71.15G



M01.01.A7.C2G



96	107	27	18

M01.00.00.00G



POMOLI ABBINABILI PAG. 339-340-341-342
KNOBS TO MATCH PAGES 339-340-341-342



M01.01.A7.15G



M01.01.A4.D1G



M01.01.A4.C1G



M01.01.A1.D1G



M01.01.115.D1G



M01.01.113.15G



M01.01.B1.15G



M01.10.00.D1G



M01.10.00.15G



M01.10.00.B1G



M01.01.02.D1G



M01.01.12.D1G

Linea Romantic

SERIE M01



96	107	27	18

M01.00.00.00G



POMOLI ABBINABILI PAG. 339-340-341-342
KNOBS TO MATCH PAGES 339-340-341-342

Linea Romantic

SERIE M09



M09.01.81.D1G



M09.01.81.15G



M09.01.04.D1G



M09.01.04.C1G



M09.01.A4.D1G



M09.01.A4.C1G



M09.01.25.15G



M09.01.00.D1G



M09.01.00.15G



M09.01.00.C2G



96	126	31	23

M09.00.00.00G



M09.10.00.D1G



M09.21.A5.D1G



POMOLI ABBINABILI PAG. 339-340-341-342
 KNOBS TO MATCH PAGES 339-340-341-342



M09.01.01.D1G



M09.01.91.D1G



M09.01.91.15G



M09.01.02.D1G



M09.01.B1.D1G



M09.01.B1.15G



M09.01.B1.B1G



M09.01.B1.C2G



M09.01.A7.D1G



M09.01.A7.15G



M09.01.A7.C1G



M09.01.A7.C2G

Linea Romantic

SERIE M09



96	126	31	23

M09.00.00.00G



POMOLI ABBINABILI PAG. 339-340-341-342
KNOBS TO MATCH PAGES 339-340-341-342

Linea Romantic

SERIE M17



M17.01.00.D1G



M17.01.00.15G



M17.01.00.B1G



M17.01.00.C1G



M17.01.00.C2G



M17.01.81.D1G



M17.01.81.C1G



M17.01.81.C2G



M17.01.A4.D1G



M17.01.A1.D1G



M17.01.115.D1G



M17.01.113.15G

* doppio interasse 96 -128
dual centres 96-128



96*	142	28	18

M17.00.00.00G



POMOLI ABBINABILI PAG. 339-340-341-342
KNOBS TO MATCH PAGES 339-340-341-342



M17.01.B1.D1G



M17.01.B1.15G



M17.01.B1.C2G



M17.01.A7.D1G



M17.01.A7.15G



M17.01.A7.C1G



M17.01.A7.C2G



M17.10.00.D1G



M17.01.02.D1G



M17.01.02.15G



M17.01.12.D1G



M17.01.12.15G

Linea Romantic

SERIE M17



* doppio interasse 96 - 128
dual centres 96-128



M17.00.00.00G

96*	142	28	18



POMOLI ABBINABILI PAG. 339-340-341-342
KNOBS TO MATCH PAGES 339-340-341-342

Linea Romantic

SERIE P18



P18.01.00.D1G



P18.01.00.15G



P18.01.00.C2G



P18.01.81.D1G



P18.01.81.C1G



P18.01.A1.D1G



P18.21.A5.D1G



P18.01.113.15G



P18.01.113.C1G



P18.01.113.C2G



⊕ ⊕	↔	⊥	⊥
-	58	25	34

P18.00.00.00G



P18.01.A4.D1G



P18.01.A4.15G



P18.01.A4.C2G



P18.10.00.D1G



P18.10.00.15G



P18.10.00.B1G

Linea Romantic

SERIE P18



P18.01.22.D1G



P18.01.A7.D1G



P18.01.A7.15G



P18.01.A7.C1G



P18.01.A7.C2G



P18.01.02.D1G



P18.00.00.00G

⊕ ⊕	↔	↑	↓
-	58	25	34



P18.01.01.D1G



P18.01.12.D1G

Linea Romantic

SERIE M26



M26.01.02.D1G



M26.01.81.D1G



M26.01.00.D1G



M26.01.00.C2G



M26.10.00.D1G



M26.01.04.D1G



M26.01.04.15G



M26.01.04.C2G



M26.01.A5.D1G



M26.01.A7.D1G



M26.01.A7.15G



M26.01.A7.C2G



128	147	29	24

M26.00.00.00G



POMOLI ABBINABILI PAG. 339-340-341-342
KNOBS TO MATCH PAGES 339-340-341-342

P17.01.00.D1G



P17.01.12.C2G

P17.01.00.15G



P17.01.25.15G

P17.01.00.B1G



P17.10.00.D1G

P17.01.00.C1G



P17.10.00.B1G

Linea Romantic

SERIE P17



P17.01.00.C2G



P17.01.A1.D1G

P17.01.02.D1G



P17.21.A5.D1G

P17.01.02.15G



P17.01.A4.D1G

P17.01.01.D1G



P17.01.A4.15G

P17.01.01.C1G



P17.01.A4.C1G

P17.01.12.D1G



P17.01.81.D1G



P17.00.00.00G

-	38	28	38

P17.01.12.15G



P17.01.81.C1G

P17.01.12.C1G



P17.01.81.C2G

Linea Romantic

SERIE M19



M19.01.00.D1G



M19.01.00.15G



M19.01.00.C1G



M19.01.00.C2G



M19.01.81.D1G



M19.01.81.C1G



M19.01.81.C2G



M19.01.A4.D1G



M19.01.A4.B1G



M19.01.A1.D1G



M19.01.115.D1G



M19.01.115.C1G



96	107	29	18

M19.00.00.00G



POMOLI ABBINABILI PAG. 339-340-341-342
KNOBS TO MATCH PAGES 339-340-341-342



M19.01.B1.D1G



M19.01.B1.C2G



M19.01.A7.D1G



M19.01.A7.15G



M19.01.A7.C1G



M19.01.A7.C2G



M19.01.02.D1G



M19.01.12.D1G



M19.01.25.15G

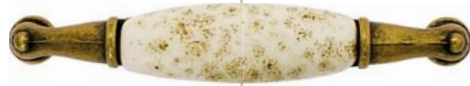

M19.10.00.D1G



M19.10.00.15G



M19.10.00.C2G

Linea Romantic

SERIE M19



M19.00.00.00G



96	107	29	18

M19.00.00.00G



POMOLI ABBINABILI PAG. 339-340-341-342
KNOBS TO MATCH PAGES 339-340-341-342

Linea Romantic

SERIE M11



M11.01.00.D1G



M11.01.00.15G



M11.01.00.B1G



M11.01.00.C2G



M11.01.A1.D1G



M11.01.A5.D1G



M11.01.90.D1G



M11.01.90.15G



M11.01.90.C1G



M11.01.81.D1G



M11.01.113.D1G



M11.01.113.C2G



96	123	28	28

M11.00.00.00G



POMOLI ABBINABILI PAG. 339-340-341-342
KNOBS TO MATCH PAGES 339-340-341-342



M11.01.04.D1G



M11.01.04.15G



M11.01.04.C1G



M11.10.00.D1G



M11.10.00.C2G



M11.01.A7.D1G



M11.01.A7.15G



M11.01.A7.B1G



M11.01.A7.C2G



M11.01.91.D1G



M11.01.91.15G



M11.01.91.B1G

Linea Romantic

SERIE M11



M11.00.00.00G

96	123	28	28



POMOLI ABBINABILI PAG. 339-340-341-342
KNOBS TO MATCH PAGES 339-340-341-342

Linea Romantic

SERIE M53



M53.01.00.D1G



M53.01.00.15G



M53.01.00.B1G



M53.01.00.C1G



M53.01.00.C2G



M53.01.A5.D1G



M53.01.81.D1G



M53.01.81.C2G



M53.00.00.00G

128	146	26	25



M53.01.A7.D1G



M53.01.A7.C2G



POMOLI ABBINABILI PAG. 339-340-341-342
 KNOBS TO MATCH PAGES 339-340-341-342



M53.10.00.D1G



M53.21.A5.D1G



M28.01.00.D1G



M28.01.00.15G



M28.01.00.B1G



M28.01.00.C1G



M28.01.00.C2G



M28.01.A5.D1G



M28.01.81.D1G



M28.01.81.C2G



M28.01.A7.D1G



M28.01.A7.C2G



M28.10.00.D1G



M28.21.A5.D1G

Linea Romantic

SERIE M28



M28.00.00.00G

96	114	26	22



POMOLI ABBINABILI PAG. 339-340-341-342
KNOBS TO MATCH PAGES 339-340-341-342

Linea Romantic

SERIE M24



M24.01.00.D1G



M24.01.00.15G



M24.01.81.D1G



M24.01.81.C2G



M24.01.A7.D1G



M24.01.A7.15G



M24.10.00.D1G



M24.21.A5.D1G



M24.01.91.D1G



M24.01.91.15G



M24.01.B1.D1G



M24.01.01.D1G



96	116	34	24

M24.00.00.00G



POMOLI ABBINABILI PAG. 339-340-341-342
KNOBS TO MATCH PAGES 339-340-341-342



M21.01.00.D1G



M21.01.00.15G



M21.01.00.C2G



M21.01.A5.D1G



M21.10.00.D1G



M21.21.A5.D1G



M21.01.81.D1G



M21.01.B1.D1G



M21.01.02.D1G



M21.01.12.D1G



M21.01.12.15G



M21.01.04.D1G

Linea Romantic

SERIE M21



96	134	33	26

M21.00.00.00G



POMOLI ABBINABILI PAG. 339-340-341-342
KNOBS TO MATCH PAGES 339-340-341-342

Linea Romantic

SERIE M16



M16.01.00.D1G



M16.01.00.15G



M16.01.00.C2G



M16.01.A1.D1G



M16.01.01.D1G



M16.01.01.15G



M16.01.113.D1G



M16.01.113.15G



M16.10.00.D1G



M16.01.B1.D1G



M16.01.B1.15G



M16.01.81.D1G



M16.00.00.00G

96	136	32	30



POMOLI ABBINABILI PAG. 339-340-341-342
 KNOBS TO MATCH PAGES 339-340-341-342



P16.01.00.D1G



P16.01.00.15G



P16.01.00.C2G



P16.01.A1.D1G



P16.01.01.D1G



P16.01.01.15G



P16.01.113.D1G



P16.01.113.15G



P16.10.00.D1G



P16.01.B1.D1G



P16.01.B1.15G



P16.01.81.D1G

Linea Romantic

SERIE P16



P16.00.00.00G

-	27	30	67

Linea Romantic

SERIE M50



M50.01.00.D1G



M50.01.00.15G



M50.01.00.C1G



M50.01.00.C2G



M50.01.81.D1G



M50.01.81.C1G



M50.01.B1.D1G



M50.01.B1.15G



M50.01.A4.D1G



M50.01.A4.15G



M50.01.A4.C1G



M50.01.A1.D1G



96	124	29	20

M50.00.00.00G



POMOLI ABBINABILI PAG. 339-340-341-342
KNOBS TO MATCH PAGES 339-340-341-342



M50.01.115.D1G



M50.01.115.C1G



M50.01.A7.D1G



M50.01.A7.15G



M50.01.A7.C1G



M50.01.A7.C2G



M50.01.02.D1G



M50.01.01.D1G



M50.01.01.15G



M50.10.00.D1G



M50.10.00.B1G



M50.01.12.D1G

Linea Romantic

SERIE M50



96	124	29	20

M50.00.00.00G



POMOLI ABBINABILI PAG. 339-340-341-342
KNOBS TO MATCH PAGES 339-340-341-342

Linea Romantic

SERIE M22



M22.01.00.D1G



M22.01.00.15G



M22.01.00.C1G



M22.01.00.C2G

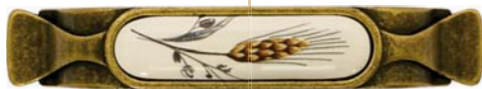

M22.01.81.D1G



M22.01.81.C1G



M22.01.A5.D1G



M22.01.91.D1G



M22.01.91.15G



M22.01.91.C2G



M22.01.A4.D1G



M22.01.A4.15G



96	129	29	18

M22.00.00.00G



POMOLI ABBINABILI PAG. 339-340-341-342
KNOBS TO MATCH PAGES 339-340-341-342



M22.01.A4.C2G



M22.01.113.D1G



M22.01.113.15G



M22.01.113.C1G



M22.01.113.C2G



M22.10.00.D1G



M22.01.115.D1G



M22.01.115.C1G



M22.01.A7.D1G



M22.01.A7.15G



M22.01.A7.C2G



M22.01.124.15G

Linea Romantic

SERIE M22



96	129	29	18

M22.00.00.00G



POMOLI ABBINABILI PAG. 339-340-341-342
KNOBS TO MATCH PAGES 339-340-341-342

Linea Romantic

SERIE M27



M27.01.00.D1G



M27.01.00.15G



M27.01.00.C1G



M27.01.00.B1G



M27.01.00.C2G



M27.01.81.D1G



M27.01.81.15G



M27.01.81.C2G



M27.01.01.D1G



M27.01.01.15G



M27.01.01.C1G



M27.01.01.C2G



96	118	30	24

M27.00.00.00G



POMOLI ABBINABILI PAG. 339-340-341-342
KNOBS TO MATCH PAGES 339-340-341-342



M27.01.115.D1G



M27.01.115.C1G



M27.01.115.B1G



M27.21.A5.D1G



M27.01.A5.D1G



M27.10.00.D1G



M27.10.00.15G



M27.01.12.D1G



M27.01.B1.D1G



M27.01.A7.D1G



M27.01.A7.15G



M27.01.A7.B1G

Linea Romantic

SERIE M27



M27.00.00.00G

96	118	30	24



POMOLI ABBINABILI PAG. 339-340-341-342
KNOBS TO MATCH PAGES 339-340-341-342

Linea Romantic

SERIE M12



M12.01.00.D1G



M12.01.00.15G



M12.01.00.C1G



M12.01.00.C2G



M12.01.02.D1G



M12.01.02.C2G



M12.01.01.D1G



M12.01.01.15G



M12.01.A4.D1G



M12.01.A4.15G



M12.01.A4.C1G



M12.01.A4.C2G



128	146	30	20

M12.00.00.00G



POMOLI ABBINABILI PAG. 339-340-341-342
KNOBS TO MATCH PAGES 339-340-341-342



M12.01.81.D1G

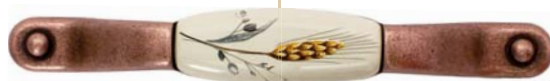

M12.01.81.C1G



M12.01.81.C2G



M12.01.B4.D1G



M12.01.25.15G



M12.21.A5.D1G



M12.10.00.D1G



M12.10.00.15G



M12.10.00.C2G



M12.01.115.D1G



M12.01.B1.D1G



M12.01.B1.15G

Linea Romantic

SERIE M12



M12.00.00.00G

128	146	30	20



POMOLI ABBINABILI PAG. 339-340-341-342
KNOBS TO MATCH PAGES 339-340-341-342

Linea Romantic

SERIE M07



M07.01.00.D1G



M07.01.00.15G



M07.01.00.B1G



M07.01.00.C1G



M07.01.00.C2G



M07.01.81.D1G



M07.01.81.C1G



M07.01.B1.D1G



M07.01.B1.15G



M07.01.02.D1G



M07.01.02.B1G



M07.01.12.D1G



96	106	31	18

M07.00.00.00G



POMOLI ABBINABILI PAG. 339-340-341-342
KNOBS TO MATCH PAGES 339-340-341-342



M07.01.12.15G



M07.01.113.D1G



M07.01.113.15G



M07.01.A4.D1G



M07.01.A4.15G



M07.01.A4.C1G



M07.01.A4.B1G



M07.01.A1.D1G



M07.01.115.D1G



M07.01.115.C1G



M07.10.00.D1G



M07.10.00.B1G

Linea Romantic

SERIE M07



96	106	31	18

M07.00.00.00G



POMOLI ABBINABILI PAG. 339-340-341-342
KNOBS TO MATCH PAGES 339-340-341-342

Linea Romantic

SERIE M51



M51.01.00.D1G



M51.01.00.15G



M51.01.00.B1G



M51.01.00.C1G



M51.01.00.C2G



M51.01.A4.D1G



M51.01.A4.15G



M51.01.A4.C1G



M51.01.A1.D1G



M51.01.115.D1G



M51.01.115.15G



M51.10.00.D1G



96	122	29	18

M51.00.00.00G



POMOLI ABBINABILI PAG. 339-340-341-342
 KNOBS TO MATCH PAGES 339-340-341-342



M51.01.81.D1G



M51.01.81.15G



M51.01.81.C2G



M51.01.A7.D1G



M51.01.A7.15G



M51.01.B1.D1G



M51.01.B1.C2G



M51.01.02.D1G



M51.01.12.D1G



M51.01.04.D1G



M51.01.113.D1G



M51.01.25.15G

Linea Romantic

SERIE M51



96	122	29	18

M51.00.00.00G



POMOLI ABBINABILI PAG. 339-340-341-342
KNOBS TO MATCH PAGES 339-340-341-342

Linea Romantic

SERIE M70



M70.01.G4.R4G



M70.01.F1.R4G



M70.01.G7.A8G



M70.01.G2.A8G



M70.01.G9.A8G



M70.01.H3.D1G



M70.01.H5.D1G



M70.01.H7.D1G



M70.01.H2.D1G



M70.01.G6.D1G



M70.01.G1.D1G



M70.01.F8.C1G



M70.00.00.00G

96	129	29	20



POMOLI ABBINABILI PAG. 339-340-341-342
KNOBS TO MATCH PAGES 339-340-341-342



M70.00.F7.R3G



M70.01.G9.R3G



M70.01.H5.E8G



M70.01.F3.E8G



M70.00.G8.E8G



M70.00.H4.M5G



M70.01.F8.M5G



M70.00.H4.CRG



M70.00.G3.F7G



M70.01.G1.B1G



M70.01.G9.C2G



M70.01.H5.C2G

Linea Romantic

SERIE M70



96	129	29	20

M70.00.00.00G



POMOLI ABBINABILI PAG. 339-340-341-342
KNOBS TO MATCH PAGES 339-340-341-342

Linea Romantic

SERIE M71



M71.01.G4.R4G



M71.01.F1.R4G



M71.01.G7.A8G



M71.01.G2.A8G



M71.01.G9.A8G



M71.01.H3.D1G



M71.01.H5.D1G



M71.01.H7.D1G



M71.01.H2.D1G



M71.01.G6.D1G



M71.01.G1.D1G



M71.01.F8.C1G



128	154	30	18

M71.00.00.00G



POMOLI ABBINABILI PAG. 339-340-341-342
 KNOBS TO MATCH PAGES 339-340-341-342



M71.00.F7.R3G



M71.01.G9.R3G



M71.01.H5.E8G



M71.01.F3.E8G



M71.00.G8.E8G



M71.00.H4.M5G



M71.01.F8.M5G



M71.00.H4.CRG



M71.00.G3.F7G



M71.01.G1.B1G



M71.01.G9.C2G



M71.01.H5.C2G

Linea Romantic

SERIE M71



M71.00.00.00G

128	154	30	18



POMOLI ABBINABILI PAG. 339-340-341-342
KNOBS TO MATCH PAGES 339-340-341-342

Linea Romantic

SERIE M72



M72.01.G4.R4G



M72.01.F1.R4G



M72.01.G7.A8G



M72.01.G2.A8G



M72.01.G9.A8G



M72.01.H3.D1G



M72.01.H5.D1G



M72.01.H7.D1G



M72.01.H2.D1G



M72.01.G6.D1G



M72.01.G1.D1G



M72.01.F8.C1G



128	158	31	26

M72.00.00.00G



POMOLI ABBINABILI PAG. 339-340-341-342
KNOBS TO MATCH PAGES 339-340-341-342



M72.00.F7.R3G



M72.01.G9.R3G



M72.01.H5.E8G



M72.01.F3.E8G



M72.00.G8.E8G



M72.00.H4.M5G



M72.01.F8.M5G



M72.00.H4.CRG



M72.00.G3.F7G



M72.01.G1.B1G



M72.01.G9.C2G



M72.01.H5.C2G

Linea Romantic

SERIE M72



M72.00.00.00G

128	158	31	26



POMOLI ABBINABILI PAG. 339-340-341-342
KNOBS TO MATCH PAGES 339-340-341-342

Linea Romantic

SERIE M73



M73.01.G4.R4G



M73.01.F1.R4G



M73.01.G7.A8G



M73.01.G2.A8G



M73.01.G9.A8G



M73.01.H3.D1G



M73.01.H5.D1G



M73.01.H7.D1G



M73.01.H2.D1G



M73.01.G6.D1G



M73.01.G1.D1G



M73.01.F8.C1G



96	125	29	24

M73.00.00.00G



POMOLI ABBINABILI PAG. 339-340-341-342
KNOBS TO MATCH PAGES 339-340-341-342



M73.00.F7.R3G



M73.01.G9.R3G



M73.01.H5.E8G



M73.01.F3.E8G



M73.00.G8.E8G



M73.00.H4.M5G



M73.01.F8.M5G



M73.00.H4.CRG



M73.00.G3.F7G



M73.01.G1.B1G



M73.01.G9.C2G



M73.01.H5.C2G

Linea Romantic

SERIE M73



M73.00.00.00G



M73.00.00.00G

96	125	29	24



POMOLI ABBINABILI PAG. 339-340-341-342
KNOBS TO MATCH PAGES 339-340-341-342

Linea Romantic

SERIE M74



M74.01.G4.R4G



M74.01.F1.R4G



M74.01.G7.A8G



M74.01.G2.A8G



M74.01.G9.A8G



M74.01.H3.D1G



M74.01.H5.D1G



M74.01.H7.D1G



M74.01.H2.D1G



M74.01.G6.D1G



M74.01.G1.D1G



M74.01.F8.C1G



128	154	33	22

M74.00.00.00G



POMOLI ABBINABILI PAG. 339-340-341-342
 KNOBS TO MATCH PAGES 339-340-341-342



M74.00.F7.R3G



M74.01.G9.R3G



M74.01.H5.E8G



M74.01.F3.E8G



M74.00.G8.E8G



M74.00.H4.M5G



M74.01.F8.M5G



M74.00.H4.CRG



M74.00.G3.F7G



M74.01.G1.B1G



M74.01.G9.C2G



M74.01.H5.C2G

Linea Romantic

SERIE M74



M74.00.00.00G

128	154	33	22



POMOLI ABBINABILI PAG. 339-340-341-342
KNOBS TO MATCH PAGES 339-340-341-342

Linea Romantic

SERIE M75



M75.01.G4.R4G



M75.01.F1.R4G



M75.01.G7.A8G



M75.01.G2.A8G



M75.01.G9.A8G



M75.01.H3.D1G



M75.01.H5.D1G



M75.01.H7.D1G



M75.01.H2.D1G



M75.01.G6.D1G



M75.01.G1.D1G



M75.01.F8.C1G



96	122	31	20

M75.00.00.00G



POMOLI ABBINABILI PAG. 339-340-341-342
KNOBS TO MATCH PAGES 339-340-341-342



M75.00.F7.R3G



M75.01.G9.R3G



M75.01.H5.E8G



M75.01.F3.E8G



M75.00.G8.E8G



M75.00.H4.M5G



M75.01.F8.M5G



M75.00.H4.CRG



M75.00.G3.F7G



M75.01.G1.B1G



M75.01.G9.C2G



M75.01.H5.C2G

Linea Romantic

SERIE M75



M75.00.00.00G

96	122	31	20



POMOLI ABBINABILI PAG. 339-340-341-342
KNOBS TO MATCH PAGES 339-340-341-342

Linea Romantic

SERIE M76



M76.01.G4.R4G



M76.01.F1.R4G



M76.01.G7.A8G



M76.01.G2.A8G



M76.01.G9.A8G



M76.01.H3.D1G



M76.01.H5.D1G



M76.01.H7.D1G



M76.01.H2.D1G



M76.01.G6.D1G



M76.01.G1.D1G



M76.01.F8.C1G



128	159	36	25

M76.00.00.00G



POMOLI ABBINABILI PAG. 339-340-341-342
 KNOBS TO MATCH PAGES 339-340-341-342



M76.00.F7.R3G



M76.01.G9.R3G



M76.01.H5.E8G



M76.01.F3.E8G



M76.00.G8.E8G



M76.00.H4.M5G



M76.01.F8.M5G



M76.00.H4.CRG



M76.00.G3.F7G



M76.01.G1.B1G



M76.01.G9.C2G



M76.01.H5.C2G

Linea Romantic

SERIE M76



M76.00.00.00G

128	159	36	25



POMOLI ABBINABILI PAG. 339-340-341-342
KNOBS TO MATCH PAGES 339-340-341-342

Linea Romantic

SERIE M77



M77.01.G4.R4G



M77.01.F1.R4G



M77.01.G7.A8G



M77.01.G2.A8G



M77.01.G9.A8G



M77.01.H3.D1G



M77.01.H5.D1G



M77.01.H7.D1G



M77.01.H2.D1G



M77.01.G6.D1G



M77.01.G1.D1G



M77.01.F8.C1G



96	127	36	26

M77.00.00.00G



POMOLI ABBINABILI PAG. 339-340-341-342
KNOBS TO MATCH PAGES 339-340-341-342



M77.00.F7.R3G



M77.01.G9.R3G



M77.01.H5.E8G



M77.01.F3.E8G



M77.00.G8.E8G



M77.00.H4.M5G



M77.01.F8.M5G



M77.00.H4.CRG



M77.00.G3.F7G



M77.01.G1.B1G



M77.01.G9.C2G



M77.01.H5.C2G

Linea Romantic

SERIE M77



M77.00.00.00G

96	127	36	26



POMOLI ABBINABILI PAG. 339-340-341-342
KNOBS TO MATCH PAGES 339-340-341-342

Linea Romantic

SERIE M78



M78.01.G4.R4G



M78.01.F1.R4G



M78.01.G7.A8G



M78.01.G2.A8G



M78.01.G9.A8G



M78.01.H3.D1G



M78.01.H5.D1G



M78.01.H7.D1G



M78.01.H2.D1G



M78.01.G6.D1G



M78.00.00.00G

128	148	32	28



POMOLI ABBINABILI PAG. 339-340-341-342
 KNOBS TO MATCH PAGES 339-340-341-342



M78.01.G1.D1G



M78.01.F8.C1G



M78.00.F7.R3G



M78.01.G9.R3G



M78.01.H5.E8G



M78.01.F3.E8G



M78.00.G8.E8G



M78.00.H4.M5G



M78.01.F8.M5G



M78.00.H4.CRG



M78.00.G3.F7G



M78.01.G1.B1G



M78.01.G9.C2G



M78.01.H5.C2G

Linea Romantic

SERIE M78



M78.00.00.00G

128	148	32	28



POMOLI ABBINABILI PAG. 339-340-341-342
KNOBS TO MATCH PAGES 339-340-341-342

Linea Romantic

SERIE M80



M80.01.G4.R4G



M80.01.F1.R4G



M80.01.G7.A8G



M80.01.G2.A8G



M80.01.G9.A8G



M80.01.H3.D1G



M80.01.H5.D1G



M80.01.H7.D1G



M80.01.H2.D1G



M80.01.G6.D1G



M80.01.G1.D1G



M80.01.F8.C1G



96	126	31	18

M80.00.00.00G



POMOLI ABBINABILI PAG. 339-340-341-342
KNOBS TO MATCH PAGES 339-340-341-342



M80.00.F7.R3G



M80.01.G9.R3G



M80.01.H5.E8G



M80.01.F3.E8G



M80.00.G8.E8G



M80.00.H4.M5G



M80.01.F8.M5G



M80.00.H4.CRG



M80.00.G3.F7G



M80.01.G1.B1G



M80.01.G9.C2G



M80.01.H5.C2G

Linea Romantic

SERIE M80



96	126	31	18

M80.00.00.00G



POMOLI ABBINABILI PAG. 339-340-341-342
KNOBS TO MATCH PAGES 339-340-341-342

Linea Romantic

SERIE M81



M81.01.G4.R4G



M81.01.F1.R4G



M81.01.G7.A8G



M81.01.G2.A8G



M81.01.G9.A8G



M81.01.H3.D1G



M81.01.H5.D1G



M81.01.H7.D1G



M81.01.H2.D1G



M81.01.G6.D1G



M81.01.G1.D1G



M81.01.F8.C1G



96	140	29	22

M81.00.00.00G



POMOLI ABBINABILI PAG. 339-340-341-342
 KNOBS TO MATCH PAGES 339-340-341-342



M81.00.F7.R3G



M81.01.G9.R3G



M81.01.H5.E8G



M81.01.F3.E8G



M81.00.G8.E8G



M81.00.H4.M5G



M81.01.F8.M5G



M81.00.H4.CRG



M81.00.G3.F7G



M81.01.G1.B1G



M81.01.G9.C2G



M81.01.H5.C2G

Linea Romantic

SERIE M81



M81.00.00.00G

96	140	29	22



POMOLI ABBINABILI PAG. 339-340-341-342
KNOBS TO MATCH PAGES 339-340-341-342



FINITURE LINEA ROMANTIC SERIE BASIC ROMANTIC BASIC FINISHES



01 > PATINATO
PATINATED



02 > BRONZO COD. 02
BRONZE CODE 02



04 > BRONZO LUCIDO
POLISHED BRONZE



06 > OTTONE LUCIDO
POLISHED BRASS



15 > ARGENTO VECCHIO
OLD SILVER



22 > NICHEL LUCIDO
POLISHED NICKEL



27 > RAME ANTICO
ANTIQUÉ COPPER



28 > RAME ANTICO
ANTIQUÉ COPPER





Romantic

Serie Basic

Disponibili solo con Finiture Basic / Available only on Basic Finishes

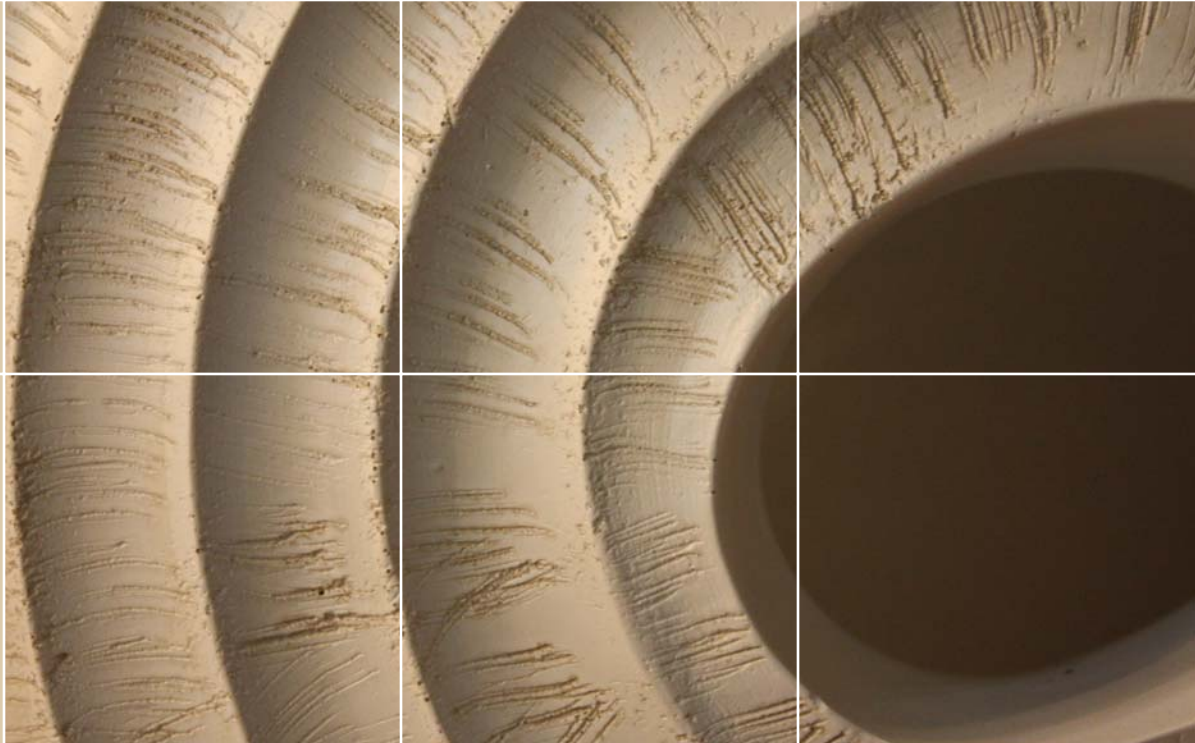

Linea Romantic



	⊕	↔	↑	↓
M01.00.00.00	96	107	27	18
M11.00.00.00	96	123	28	28
M16.00.00.00	96	136	32	30
M17.00.00.00	96*	142	28	18
M21.00.00.00	96	134	33	26
M51.00.00.00	96	122	29	18

* doppio interasse 96 -128
dual centres 96-128

	⊙	↔	↑	↓
P01.00.00.00	-	43	34	25
P02.00.00.00	-	34	25	24
P03.00.00.00	35	-	30	-
P04.00.00.00	31	-	26	-
P05.00.00.00	28	-	27	-
P07.00.00.00	34	-	25	-
P08.00.00.00	29	-	24	-



M16.01.81.04



M11.01.81.04



M21.01.81.04

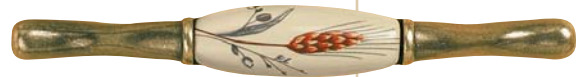

M17.01.81.04



M51.01.81.04

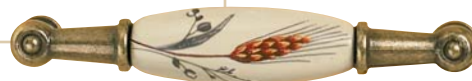

M01.01.81.04



P07.01.81.04



P08.01.81.04



P03.01.81.06



P04.01.81.06



P05.01.81.06



P01.01.81.06



P02.01.81.06



M01.01.00.04



M02.01.00.04



M01.01.00.15



P07.01.00.04



P08.01.00.04



P09.01.00.04



M01.01.04.04



M01.01.12.04



M02.01.01.04



M01.01.02.04



M01.01.05.04



M01.01.08.04



M17.01.00.04



M17.01.02.04

Linea Romantic



	⊕ ⊖	↔	↑ ↓	↕
M01.00.00.00	96	107	27	18
M02.00.00.00	96	107	27	18
M17.00.00.00	96*	136	32	30

* doppio interasse 96 -128
dual centres 96-128

	∅	↔	↑ ↓	↕
P07.00.00.00	34	-	25	-
P08.00.00.00	29	-	24	-
P09.00.00.00	24	-	22	-

Linea Romantic



96	126	31	23

M09.00.00.00



M09.01.00.04



M09.01.00.15



M09.01.01.04



M09.01.02.04



M09.01.81.04

44	-	36	-
P14.00.00.00			
P23.00.00.00			
55	-	34	62

P14.00.00.00

P23.00.00.00



P23.00.00.04 diam. 55



P23.01.00.04 diam. 55



P14.01.00.04 diam. 44



P23.02.00.01 diam. 55



P23.10.00.01 diam. 55



P14.01.81.04 diam. 44



M10.01.00.04



M10.01.81.04



M10.01.02.04



M10.01.01.04



M10.01.12.04



M10.01.115.04



M10.01.00.15



M10.01.51.04

Linea Romantic



M10.00.00.00

96	125	30	20

Linea Romantic



	↔	↔	↑	↑
M19.00.00.00	96	107	29	18
M20.00.00.00	96	107	29	18

M19.00.00.00
M20.00.00.00



M19.01.00.04



M20.01.00.04



M19.01.00.15



M20.01.00.15



M19.01.05.15



M19.01.81.04



M19.01.02.04



M19.01.20.04



P07.01.20.04



P08.01.20.04



P07.00.00.00
P08.00.00.00

∅	↔	↑	↑
P07.00.00.00	34	-	25
P08.00.00.00	29	-	24



M22.01.00.04



M22.01.51.04



P08.01.51.04



P07.01.51.04



Linea Romantic



M22.00.00.00	96	129	29 18
M51.00.00.00	96	122	29 18

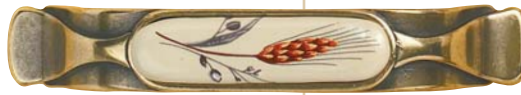

M22.01.81.04



M51.01.00.04



P07.00.00.00	34	-	25 -
P08.00.00.00	29	-	24 -



M51.01.02.04



M51.01.11.04



M51.01.12.04



M51.01.00.15



Linea Romantic



M50.00.00.00

96	124	29	20



M50.01.00.04



M50.01.81.04



M50.01.12.04

P07.00.00.00

34	-	25	-
P08.00.00.00	29	-	24
P09.00.00.00	24	-	22



P07.01.12.04



P08.01.12.04



M50.01.01.04



P07.01.01.04



P08.01.01.04



P09.01.01.04



P07.01.02.04



P08.01.02.04



P07.01.04.04



P08.01.04.04



P09.01.04.04



P07.01.05.04



P08.01.05.04



P09.01.05.04



M50.01.02.04



P07.01.00.15



Linea Romantic



P08.01.00.15



P09.01.00.15



M50.01.00.15



	⊕ ⊖	↔	↑ ↓	↕
M17.00.00.00	96*	142	28	18
M19.00.00.00	96	107	29	18
M50.00.00.00	96	124	29	20



M50.01.25.15



M50.01.01.27



P07.01.01.27



P08.01.01.27



P09.01.01.27

* doppio interasse 96 -128
dual centres 96-128



M17.01.02.27



P07.01.02.27



P08.01.02.27



M19.01.03.27



P07.01.03.27



P08.01.03.27



P09.01.03.27

	∅	↔	↑ ↓	↕
P07.00.00.00	34	-	25	-
P08.00.00.00	29	-	24	-
P09.00.00.00	24	-	22	-

Linea Romantic



	Ø	↔	↑	↓
M01.00.00.00	96	107	27	18
M10.00.00.00	96	125	30	20



M10.10.00.01



Pietra / Stone



P07.10.00.01



P08.10.00.01



P01.10.00.01



P02.10.00.01



P03.10.00.01



P04.10.00.01



P05.10.00.01



M01.02.00.01



Gress



P07.02.00.01



P08.02.00.01



P09.02.00.01

	Ø	↔	↑	↓
P01.00.00.00	-	43	34	25
P02.00.00.00	-	34	25	24
P03.00.00.00	35	-	30	-
P04.00.00.00	31	-	26	-
P05.00.00.00	28	-	27	-
P06.00.00.00	21	-	21	-
P07.00.00.00	34	-	25	-
P08.00.00.00	29	-	24	-

	Ø	↔	↑	↓
P09.00.00.00	24	-	22	-
P10.00.00.00	36	-	31	-
P11.00.00.00	31	-	29	-



P01.02.00.01



P02.02.00.01



P06.02.00.01



P03.02.00.01



P04.02.00.01



P05.02.00.01



P10.02.00.01



P11.02.00.01



M01.02.02.01



Gress



P07.02.02.01



P08.02.02.01



P01.02.02.01



P02.02.02.01



P03.02.02.01



P04.02.02.01



P05.02.02.01



M01.02.03.01



Gress



P07.02.03.01



P08.02.03.01



P09.02.03.01



P01.02.04.01



P02.02.04.01



P06.02.04.01



P03.02.04.01



P04.02.04.01



P05.02.04.01

Linea Romantic



M01.00.00.00

96	107	27	18

P01.00.00.00

-	43	34	25
P02.00.00.00	-	34	25
P03.00.00.00	35	-	30
P04.00.00.00	31	-	26
P05.00.00.00	28	-	27
P06.00.00.00	21	-	21
P07.00.00.00	34	-	25
P08.00.00.00	29	-	24

P09.00.00.00

24	-	22	-

Linea Romantic



96	107	27	18

M01.00.00.00



M01.02.20.01



Gress



P07.02.20.01



P08.02.20.01



P01.02.20.01



P02.02.20.01



P03.02.20.01



P04.02.20.01



P05.02.20.01



M01.02.12.01



Gress



P07.02.12.01



P08.02.12.01

-	43	34	25
-	34	25	24
35	-	30	-
31	-	26	-
28	-	27	-
34	-	25	-
29	-	24	-
24	-	22	-

P01.00.00.00

P02.00.00.00

P03.00.00.00

P04.00.00.00

P05.00.00.00

P07.00.00.00

P08.00.00.00

P09.00.00.00



M01.02.05.01



Gress



P07.02.05.01



P08.02.05.01



P09.02.05.01



M01.02.01.01



Gress



P07.02.01.01



P08.02.01.01



P09.02.01.01



P01.00.25.06



P02.00.25.06



P03.00.25.06



P04.00.25.06



P05.00.25.06



P01.00.20.06



P02.00.20.06



P03.00.20.06



P04.00.20.06



P05.00.20.06



P01.00.04.06



P02.00.04.06



P03.00.04.06



P04.00.04.06



P05.00.04.06



P04.00M01B02



P04.00M01V02



P04.00M01R02



P04.00.77.02

Linea Romantic



	∅	↔	↑	↓
P01.00.00.00	-	43	34	25
P02.00.00.00	-	34	25	24
P03.00.00.00	35	-	30	-
P04.00.00.00	31	-	26	-
P05.00.00.00	28	-	27	-

Linea Romantic



	∅	↔	↑	↓
P01.00.00.00	-	43	34	25
P02.00.00.00	-	34	25	24
P03.00.00.00	35	-	30	-
P04.00.00.00	31	-	26	-
P05.00.00.00	28	-	27	-
P06.00.00.00	21	-	21	-



P01.01.05.06



P02.01.05.06



P06.01.05.06



P03.01.05.06



P04.01.05.06



P05.01.05.06



P01.01.02.06



P02.01.02.06



P03.01.02.06



P04.01.02.06



P05.01.02.06



P01.01.01.06



P02.01.01.06



P06.01.01.06



P03.01.01.06



P04.01.01.06



P05.01.01.06



P01.01.22.06



P02.01.22.06



P06.01.22.06



P03.01.22.06



P04.01.22.06



P05.01.22.06



P01.01.12.06



P02.01.12.06



P03.01.12.06



P04.01.12.06



P05.01.12.06



P01.00.00.06



P02.00.00.06



P06.00.00.06



P03.00.00.06



P04.00.00.06



P05.00.00.06

Linea Romantic



P10.00.00.06



P11.00.00.06



P01.01.00.06



P02.01.00.06



P06.01.00.06



P03.01.00.06



P04.01.00.06



P05.01.00.06



P10.01.00.06



P11.01.00.06

∅	↔	↑	↓
P01.00.00.00	- 43	34	25
P02.00.00.00	- 34	25	24
P03.00.00.00	35	-	30
P04.00.00.00	31	-	26
P05.00.00.00	28	-	27
P06.00.00.00	21	-	21
P10.00.00.00	36	-	31
P11.00.00.00	31	-	29





Ceramics

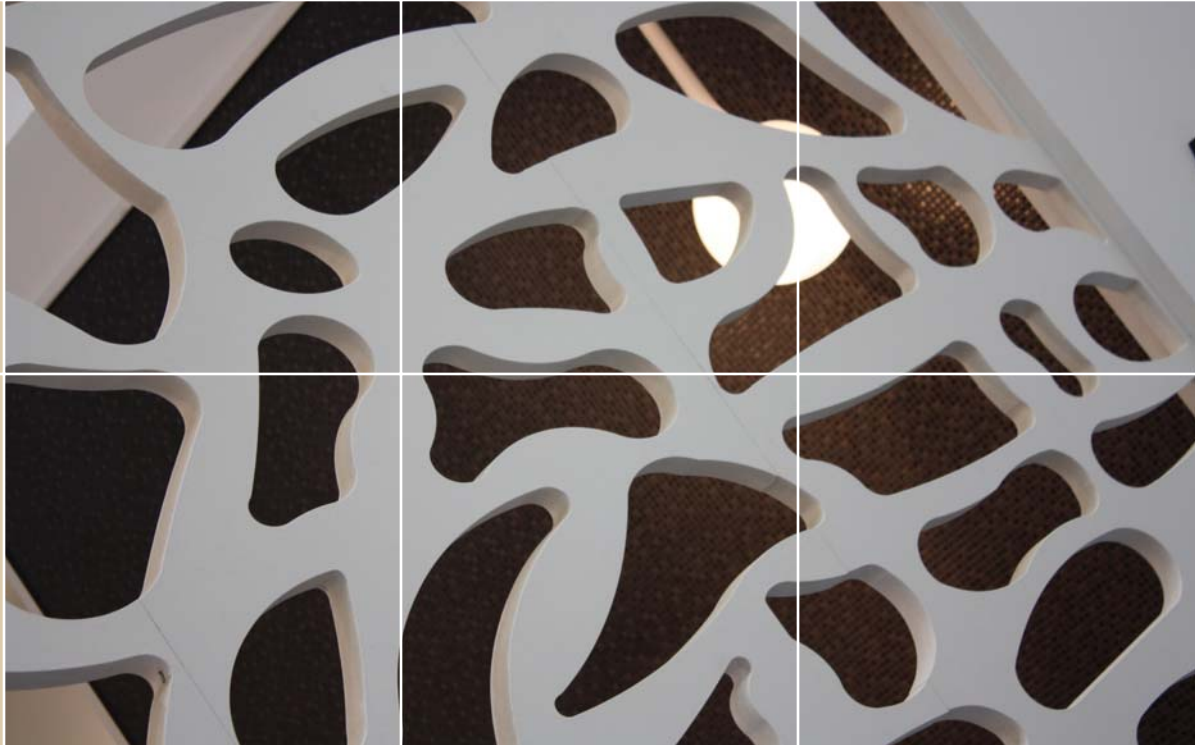

FINITURE LINEA CERAMICS

CERAMICS FINISHES

 .000000 > BIANCO
WHITE

 .010000 > AVORIO
IVORY

 .240000 > BORDEAUX
BORDEAUX

 .230000 > NERO OPACO
MATT BLACK

 .070000 > NERO
BLACK



SIMBOLOGIA

SYMBOLOLOGY



INTERASSE
DISTANCE BETWEEN CENTRES



ALTEZZA
HEIGHT



DIAMETRO
DIAMETER



LUNGHEZZA
LENGTH



LARGHEZZA
WIDTH





Linea Ceramics

SERIE 110



GIUSTI



P110A.000000

COLORI SMALTO / ENAMEL COLOUR

-   .000000 > BIANCO
WHITE
-   .010000 > AVORIO
IVORY
-   .240000 > BORDEAUX
BORDEAUX
-   .230000 > NERO OPACO
MATT BLACK
-   .070000 > NERO
BLACK



			
-	78	45	78

P110B.000000

DECORI / ORNAMENT

-   .00AA00
-   .00BB00
-   .01AA00
-   .01BB00
-   .24AA00
-   .24BB00



			
-	58	35	58

P110C.000000

-   .23AA00
-   .23BB00
-   .07AA00
-   .07BB00



			
-	36	28	36

La decorazione è una lavorazione artigianale realizzata interamente a mano con Oro o Platino. Ogni prodotto è unico ed irripetibile.

The completely handcrafted decoration is made by hand using Gold or Platinum. Therefore, each item is one of a kind.



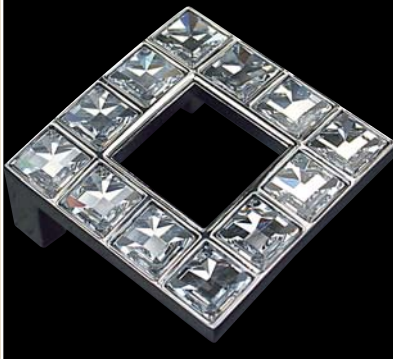

Luxury

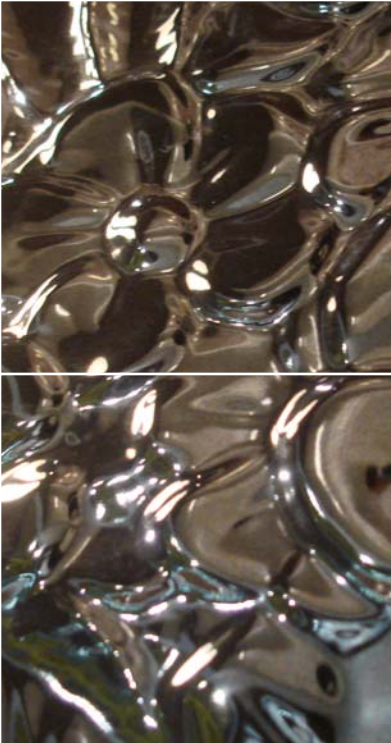

FINITURE LINEA LUXURY LUXURY FINISHES

 0003 > NICHEL SATINATO
NICKEL SATINED

 0002 > CROMO LUCIDO
POLISHED CHROME

 0015 > ARGENTO VECCHIO
OLD SILVER

 00GP > PLACCATO ORO
GOLD PLATED

 00D1 > ANTICA FIRENZE
ANTIQUE FLORENCE

 00E2 > CANNA DI FUCILE
GUN METAL GRAY

 00L8 > TOTAL BLACK NICHEL
TOTAL BLACK NICKEL

 DPGP > DIAMANTATO PAVÉ PLACCATO ORO
DIAMANTATO PAVÉ GOLD PLATED

 DPWG > DIAMANTATO PAVÉ ORO BIANCO
DIAMANTATO PAVÉ WHITE GOLD

 PD > PALLADIO
PALLADIUM

 OR > ORO 24 K
GOLD 24 K

 RT > RUTENIO
RUTHENIUM

CRISTALLI CRYSTAL

MADE WITH SWAROVSKI® ELEMENTS

 KR02 > CRISTALLO TRASPARENTE
CRYSTAL TRANSPARENT

 EM02 > CRISTALLO SMERALDO
CRYSTAL EMERALD

 SA02 > CRISTALLO VERDE SALVIA
CRYSTAL GREEN SAGE

 BL02 > CRISTALLO BLU
CRYSTAL BLUE

 BK02 > CRISTALLO NERO
BLACK CRYSTAL



SIMBOLOGIA SYMBOLOLOGY



INTERASSE
DISTANCE BETWEEN CENTRES



ALTEZZA
HEIGHT



DIAMETRO
DIAMETER



LUNGHEZZA
LENGHT



LARGHEZZA
WIDTH



LUNGHEZZA CHIAVE
KEY LENGHT

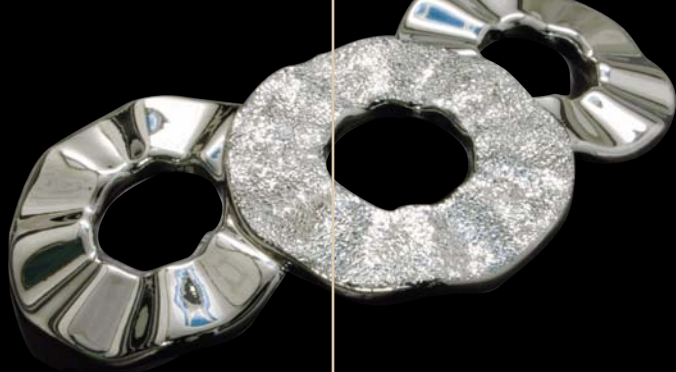

linea
Luxury

SERIE 608
DIAMANTATO PAVÉ



GIUSTI



WMN608.128



128	140	23	50

WMN608.064



64	75	22	43

La finitura è una lavorazione artigianale realizzata interamente a mano con una tecnica di gioielleria denominata diamantatura a pavé. Successivamente viene rivestito con diversi metalli preziosi come: Oro giallo / Oro bianco puri al 99,99%, che ne conferiscono la brillantezza inimitabile della superficie. Ogni prodotto è unico ed irripetibile.
La prestigiosa Linea Luxury Serie Diamantato Pavé è espressione di altissima qualità.

WPO608.064

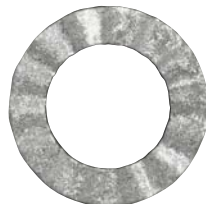

64	74	20	74

WPO608.032



32	38	18	38

The completely handcrafted finishing is obtained with the "pavé diamond setting" technique, also used in jewellery. The handle is then completely coated with different precious metals, such as 99,99% pure white and yellow gold, which provide a matchless shine to the surface of the handle. Therefore, each item is one of a kind. The prestigious Linea Luxury Serie Diamantato Pavé stands for very high quality.

FINITURE / FINISHING

-  DPGP > DIAMANTATO PAVÉ PLACC. ORO
DIAMANTATO PAVÉ GOLD PLATED
-  DPWG > DIAMANTATO PAVÉ ORO BIANCO
DIAMANTATO PAVÉ WHITE GOLD

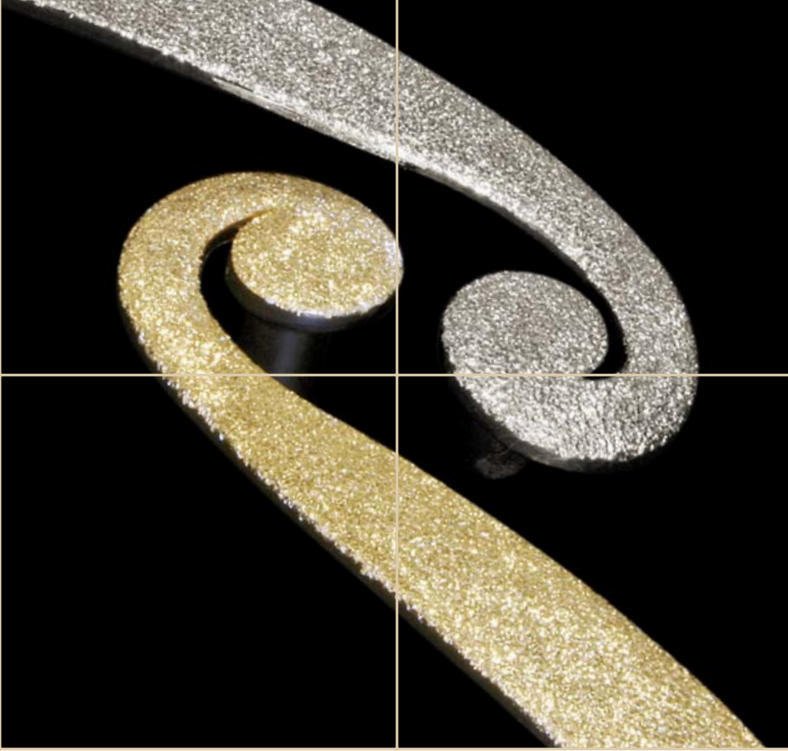

linea
Luxury

SERIE 614
DIAMANTATO PAVÉ



GIUSTI

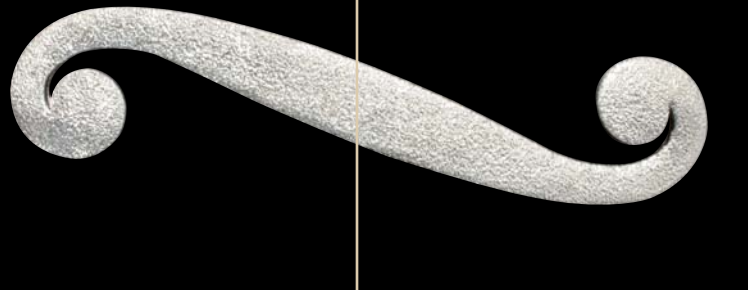

La finitura è una lavorazione artigianale realizzata interamente a mano con una tecnica di gioielleria denominata diamantatura a pavé. Successivamente viene rivestito con diversi metalli preziosi come: Oro giallo / Oro bianco puri al 99,99%, che ne conferiscono la brillantezza inimitabile della superficie. Ogni prodotto è unico ed irripetibile. La prestigiosa Linea Luxury Serie Diamantato Pavé è espressione di altissima qualità.

WMN614.S96



⊕ ⊕	↔	↑	↓
96	124	22	30

WMN614.D96



⊕ ⊕	↔	↑	↓
96	124	22	30

The completely handcrafted finishing is obtained with the "pavé diamond setting" technique, also used in jewellery. The handle is then completely coated with different precious metals, such as 99,99% pure white and yellow gold, which provide a matchless shine to the surface of the handle. Therefore, each item is one of a kind. The prestigious Linea Luxury Serie Diamantato Pavé stands for very high quality.

WMN614.S64



⊕ ⊕	↔	↑	↓
64	92	22	30

WMN614.D64



⊕ ⊕	↔	↑	↓
64	92	22	30

FINITURE / FINISHING

-  DPGP > DIAMANTATO PAVÉ PLACCATO ORO
DIAMANTATO PAVÉ GOLD PLATED
-  DPWG > DIAMANTATO PAVÉ ORO BIANCO
DIAMANTATO PAVÉ WHITE GOLD

WPO602.030



⊕ ⊕	↔	↑	⊘
-	-	20	30

WBC8037/SP

> WCH7200/42
WCH7200/53



⊕ ⊕	↔	↑	↓	⊘	
-	20	-	44		
		⊞	↔	↓	⊘
42	25	70	6		
53	25	81	6		



linea Luxury

SERIE 602
DIAMANTATO PAVÉ



GIUSTI

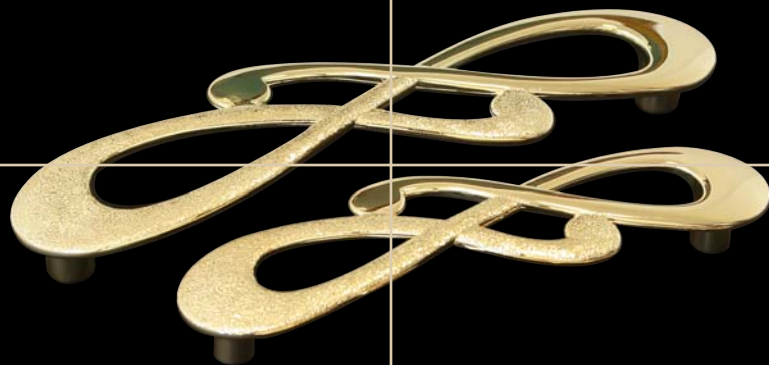

WMN602.128



128	148	22	40

La finitura è una lavorazione artigianale realizzata interamente a mano con una tecnica di gioielleria denominata diamantatura a pavé. Successivamente viene rivestito con diversi metalli preziosi come: Oro giallo / Oro bianco puri al 99,99%, che ne conferiscono la brillantezza inimitabile della superficie. Ogni prodotto è unico ed irripetibile.
La prestigiosa Linea Luxury Serie Diamantato Pavé è espressione di altissima qualità.

WMN602.096



96	116	21	32

WBC602.096



96	32	-	115

The completely handcrafted finishing is obtained with the "pavé diamond setting" technique, also used in jewellery. The handle is then completely coated with different precious metals, such as 99,99% pure white and yellow gold, which provide a matchless shine to the surface of the handle. Therefore, each item is one of a kind. The prestigious Linea Luxury Serie Diamantato Pavé stands for very high quality.

WPO602.030



-	-	20	30

WBC8037/SP



-	20	-	44

> WCH7200/42
WCH7200/53



42	25	70	6
53	25	81	6

FINITURE / FINISHING

- DPGP > DIAMANTATO PAVÉ PLACC. ORO
DIAMANTATO PAVÉ GOLD PLATED
- DPWG > DIAMANTATO PAVÉ ORO BIANCO
DIAMANTATO PAVÉ WHITE GOLD



linea
Luxury

SERIE 010
MADE WITH SWAROVSKI® ELEMENTS



GIUSTI



L'articolo è di produzione artigianale realizzato interamente a mano utilizzando materiali pregiati.

Il prodotto viene ottenuto dalla microfusione sottovuoto dell'ottone utilizzata nella fabbricazione dei gioielli, viene rivestito in diversi metalli preziosi come:

Palladio / Oro / Rutenio puri al 99,99 %, che ne conferiscono una brillantezza inimitabile della superficie. Vengono utilizzati per la maniglia: n. 376 STRASS® Round Stones Xilion Chaton e n. 178 STRASS® Round Stones Xilion Chaton per il pomolo, incastonati a mano.

Ogni prodotto è unico ed irripetibile.

LMN010.096.KRPD



⊕	↔	↑	↓
96	136	31	28

LP0010.030



⊕	↔	↑	∅
-	30	21	30

The item is completely hand-crafted with precious materials. The product is obtained by the vacuum casting of brass, also used in the jewellery, it is plated with different valuable metals such as:

Palladium / Gold / Ruthenium - 99,99% pure, which grant for a unrivalled shine of the surface. We used for the handle: no. 376 STRASS® Round Stones Xilion Chaton and no. 178 STRASS® Round Stones Xilion Chaton for the knob, all set by hand.

Each product is unique and "one-shot".

LMN010.096.KROR



⊕	↔	↑	↓
96	136	31	28

LCH010.048



⊕	↔	↑	∅
48	29	90	6

CRISTALLO / CRYSTAL



.KRO2> CRISTALLO TRASPARENTE
CRYSTAL TRANSPARENT

MADE WITH SWAROVSKI® ELEMENTS

FINITURE / FINISHING



KRPD > PALLADIO
PALLADIUM



KROR > ORO
GOLD



KRRT > RUTENIO
RUTHENIUM

LMN010.096.KRRT



⊕	↔	↑	↓
96	136	31	28

LBC010.000



⊕	↔	↑	↓
-	28	-	43



linea
Luxury

SERIE 005



GIUSTI



LMN005.096.ABPD



⌀	↔	↑	=
96	134	35	19

LP0005.030.ABPD



⌀	↔	↑	∅
-	-	21	30

L'articolo è di produzione artigianale realizzato interamente a mano utilizzando materiali pregiati. Il prodotto viene ottenuto dalla microfusione sottovuoto dell'ottone utilizzata nella fabbricazione dei gioielli, viene rivestito in diversi metalli preziosi come:

Palladio / Oro / Rutenio puri al 99,99%, che ne conferiscono una brillantezza inimitabile della superficie. Viene utilizzata resina epossidica trasparente applicata a mano con sfumature di marrone ambrato, che a seconda dello spessore virano da colori più chiari a colori più scuri. Sulla maniglia sono presenti oltre 120 applicazioni ed oltre 80 sul pomolo. Ogni prodotto è unico ed irripetibile. La prestigiosa linea Luxury Serie 005 è espressione di altissima qualità.

LMN005.096.ABOR



⌀	↔	↑	↑
96	134	35	19

LP0005.030.ABOR



⌀	↔	↑	∅
-	-	21	30

The item is completely hand-crafted with precious materials. The product is obtained by the vacuum casting of brass, also used in the jewellery, it is plated with different valuable metals such as:

Palladium / Gold / Ruthenium - 99,99% pure, which grant for a unrivalled shine of the surface. We used transparent epoxy resin laid on by hand with amber brown nuances, which can be intensified or lightened depending on the thickness of the application. On the handle there are over 120 applications and on the knob over 80. Each product is unique and "one-shot". The prestigious Luxury Line Series 005 is expression of very high quality.

LMN005.096.ABRT



⌀	↔	↑	↑
96	134	35	19

LP0005.030.ABRT



⌀	↔	↑	∅
-	-	21	30

SMALTO / ENAMEL

 **AB** > MARRONE AMBRA
AMBER BROWN

FINITURE / FINISHING

 **ABPD** > PALLADIO
PALLADIUM

 **ABOR** > ORO
GOLD

 **ABRT** > RUTENIO
RUTHENIUM



linea
Luxury

SERIE 550
MADE WITH SWAROVSKI® ELEMENTS



GIUSTI

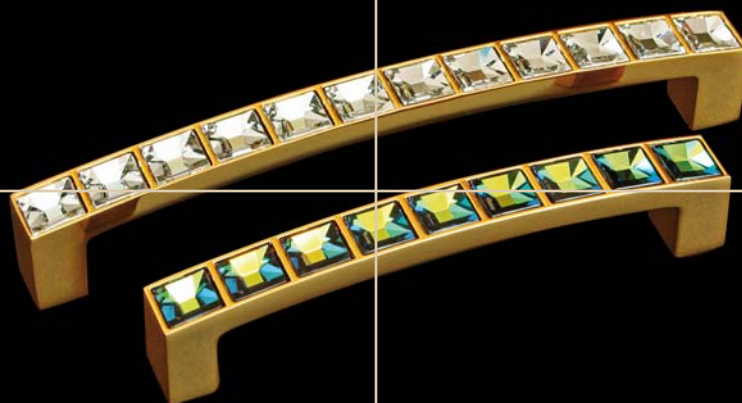



CRISTALLI / CRYSTAL
MADE WITH SWAROVSKI® ELEMENTS

-  **.KR02 > CRISTALLO TRASPARENTE**
CRYSTAL TRANSPARENT
-  **.EM02 > CRISTALLO SMERALDO**
CRYSTAL EMERALD
-  **.SA02 > CRISTALLO VERDE SALVIA**
CRYSTAL GREEN SAGE
-  **.BL02 > CRISTALLO BLU**
CRYSTAL BLUE

WMN550.128







			
128	140	25	13

FINITURE / FINISHING

-  **.KR02 > CROMO LUCIDO**
POLISHED CHROME
-  **.KR03 > NICHEL SATINATO**
NICKEL SATINED
-  **.KR04 > CROMO OPACO**
MATT CROME
-  **.KR15 > ARGENTO VECCHIO**
OLD SILVER
-  **.KRE2 > CANNA DI FUCILE**
BLACK NICKEL
-  **.KRD1 > ANTICA FIRENZE**
ANTIQU FLORENCE
-  **.KRGP > PLACCATO ORO**
GOLD PLATED

WMN550.096



			
96	107	22	13

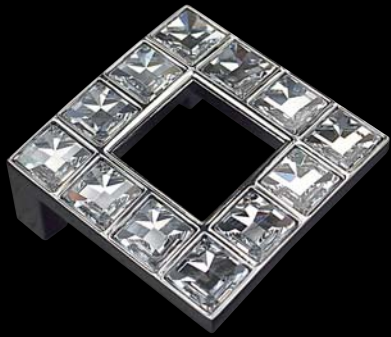

linea
Luxury

SERIE 550
MADE WITH SWAROVSKI® ELEMENTS



GIUSTI



WP0550.032

CRISTALLI / CRYSTAL
MADE WITH SWAROVSKI® ELEMENTS



.KR02 > CRISTALLO TRASPARENTE
CRYSTAL TRANSPARENT



.EM02 > CRISTALLO SMERALDO
CRYSTAL EMERALD



.SA02 > CRISTALLO VERDE SALVIA
CRYSTAL GREEN SAGE



.BL02 > CRISTALLO BLU
CRYSTAL BLUE

32	49	24	49

WP0550.016



16	25	23	25

FINITURE / FINISHING



.KR02 > CROMO LUCIDO
POLISHED CHROME



.KR03 > NICHEL SATINATO
NICKEL SATINED

WP0550.000



-	13	21	13



.KR04 > CROMO OPACO
MATT CROME



.KR15 > ARGENTO VECCHIO
OLD SILVER



.KRE2 > CANNA DI FUCILE
BLACK NICKEL



.KRD1 > ANTICA FIRENZE
ANTIQUE FLORENCE



.KRGP > PLACCATO ORO
GOLD PLATED



linea
Luxury

SERIE 633
MADE WITH SWAROVSKI® ELEMENTS



GIUSTI



WMN633.128



128	145	25	21

CRISTALLO / CRYSTAL

.KR02 > CRISTALLO TRASPARENTE
CRYSTAL TRANSPARENT
MADE WITH SWAROVSKI® ELEMENTS

WMN633.096



96	114	25	21

FINITURE / FINISHING

.KR02 > CROMO LUCIDO
POLISHED CHROME

WP0633.C32

.KR03 > NICHEL SATINATO
NICKEL SATINED

.KR15 > ARGENTO VECCHIO
OLD SILVER

.KRE2 > CANNA DI FUCILE
BLACK NICKEL

.KRD1 > ANTICA FIRENZE
ANTIQUÉ FLORENCE

.KRGP > PLACCATO ORO
GOLD PLATED



32	48	21	21



linea
Luxury

SERIE 633
MADE WITH SWAROVSKI® ELEMENTS



GIUSTI



WP0633.A64

64	86	24	86



WP0633.B32

32	50	24	50

CRISTALLO / CRYSTAL

.KR02 > CRISTALLO TRASPARENTE
CRYSTAL TRANSPARENT
MADE WITH SWAROVSKI® ELEMENTS

FINITURE / FINISHING

.KR02 > CROMO LUCIDO
POLISHED CHROME



WP0633.017

-	-	21	17

- .KR03 > NICHEL SATINATO
NICKEL SATINED
- .KR15 > ARGENTO VECCHIO
OLD SILVER
- .KRE2 > CANNA DI FUCILE
BLACK NICKEL
- .KRD1 > ANTICA FIRENZE
ANTIQUE FLORENCE
- .KRGP > PLACCATO ORO
GOLD PLATED

linea Luxury

SERIE 640
MADE WITH SWAROVSKI® ELEMENTS



GIUSTI

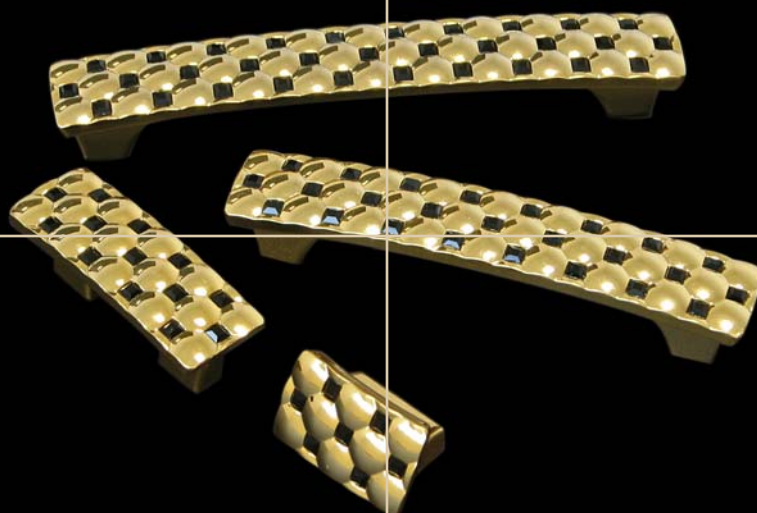

COMBINAZIONI METALLO-CRISTALLO

METAL-CRYSTAL MATCHING
MADE WITH SWAROVSKI® ELEMENTS

 .KR02 > CRISTALLO + CROMO LUCIDO
CRYSTAL + POLISHED CHROME





 .BK02 > NERO + CROMO LUCIDO
BLACK + POLISHED CHROME

 .KR03 > CRISTALLO + NICHEL SATINATO
CRYSTAL + NICKEL SATINED

 .BK03 > NERO + NICHEL SATINATO
BLACK + NICKEL SATINED



WMN640.128

			
128	150	25	22

 .KRE8 > CRISTALLO + ARGENTO VECCH.
CRYSTAL + ANTIQUE SILVER

 .BKE8 > NERO + ARGENTO VECCHIO
BLACK + ANTIQUE SILVER





 .KRL8 > CRISTALLO + TOTAL BLACK
CRYSTAL + TOTAL BLACK

 .BKL8 > NERO + TOTAL BLACK NICHEL
BLACK + TOTAL BLACK NICKEL

 .KRD1 > CRISTALLO + ANTICA FIRENZE
CRYSTAL + ANTIQUE FLORENCE



WMN640.096

			
96	121	25	22

 .BKD1 > NERO + ANTICA FIRENZE
BLACK + ANTIQUE FLORENCE

 .KRGP > CRISTALLO + PLACCATO ORO
CRYSTAL + GOLD PLATED

 .BKGP > NERO + PLACCATO ORO
BLACK + GOLD PLATED



linea
Luxury

SERIE 640
MADE WITH SWAROVSKI® ELEMENTS



GIUSTI

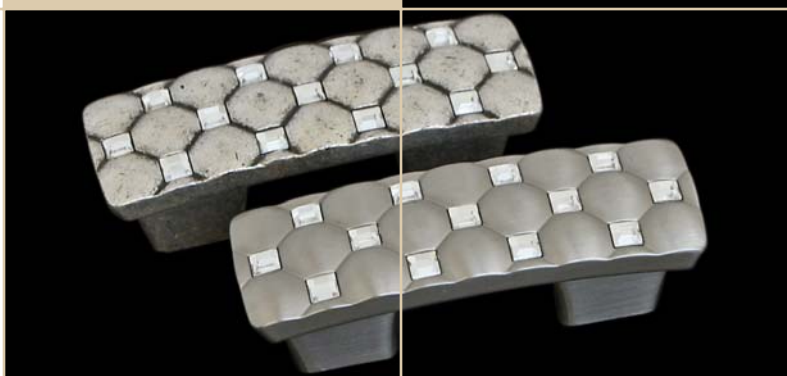

WP0640.032



32	65	23	22

COMBINAZIONI METALLO-CRISTALLO
METAL-CRYSTAL MATCHING
MADE WITH SWAROVSKI® ELEMENTS

-  .KR02 > CRISTALLO + CROMO LUCIDO
CRYSTAL + POLISHED CHROME
-  .BK02 > NERO + CROMO LUCIDO
BLACK + POLISHED CHROME
-  .KR03 > CRISTALLO + NICHEL SATINATO
CRYSTAL + NICKEL SATINED
-  .BK03 > NERO + NICHEL SATINATO
BLACK + NICKEL SATINED

WP0640.016



(16)	37	21	22

-  .KR8 > CRISTALLO + ARGENTO VECCH.
CRYSTAL + ANTIQUE SILVER
-  .BK8 > NERO + ARGENTO VECCHIO
BLACK + ANTIQUE SILVER
-  .KRL8 > CRISTALLO + TOTAL BLACK
CRYSTAL + TOTAL BLACK
-  .BKL8 > NERO + TOTAL BLACK NICHEL
BLACK + TOTAL BLACK NICKEL
-  .KRD1 > CRISTALLO + ANTICA FIRENZE
CRYSTAL + ANTIQUE FLORENCE

-  .BKD1 > NERO + ANTICA FIRENZE
BLACK + ANTIQUE FLORENCE
-  .KRGP > CRISTALLO + PLACCATO ORO
CRYSTAL + GOLD PLATED
-  .BKGP > NERO + PLACCATO ORO
BLACK + GOLD PLATED



linea
Luxury

SERIE 655
MADE WITH SWAROVSKI® ELEMENTS



GIUSTI

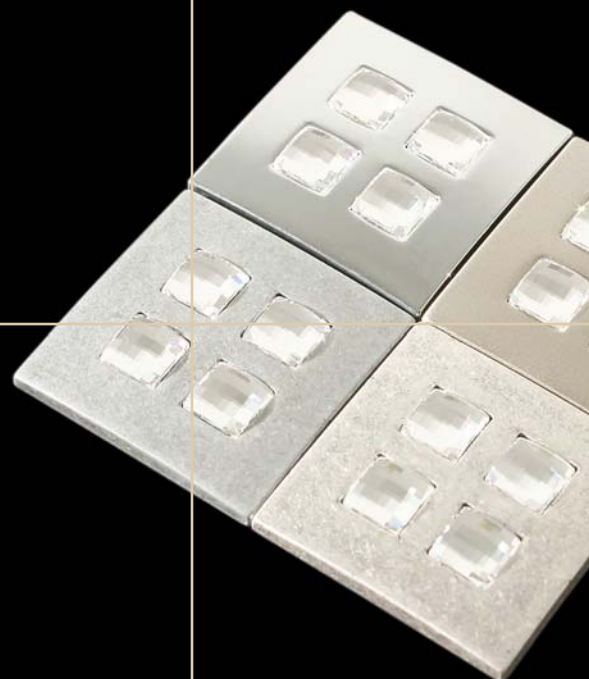

WP0655.016



16	54	22	54

CRISTALLO / CRYSTAL



.KR02 > CRISTALLO TRASPARENTE
CRYSTAL TRANSPARENT
MADE WITH SWAROVSKI® ELEMENTS

WP0655.000



-	36	18	36

FINITURE / FINISHING



.KR02 > CROMO LUCIDO
POLISHED CHROME

.KR03 > NICHEL SATINATO
NICKEL SATINED

.KRE8 > ARGENTO VECCHIO BRILL.
SHINY OLD SILVER

.KR20 > FORGIA ANTICA
ANTIQUE FORGE

.KRD1 > ANTICA FIRENZE
ANTIQUE FLORENCE



linea
Luxury

SERIE 667
MADE WITH SWAROVSKI® ELEMENTS



GIUSTI



WMN667.128



⊕ ⊕	↔	↑	↓
128	142	30	14

WMN667.096



⊕ ⊕	↔	↑	↓
96	112	29	14

CRISTALLO / CRYSTAL

 **.KR02 > CRISTALLO TRASPARENTE**
CRYSTAL TRANSPARENT
MADE WITH SWAROVSKI® ELEMENTS

FINITURE / FINISHING

 **.KR02 > CROMO LUCIDO**
POLISHED CHROME

WMN667.032



⊕ ⊕	↔	↑	↓
32	48	23	14

WPN667.016



⊕ ⊕	↔	↑	↓
16	14	23	58

-  **.KR03 > NICHEL SATINATO**
NICKEL SATINED
-  **.KRE8 > ARGENTO VECCHIO BRILL.**
SHINY OLD SILVER
-  **.KRE2 > CANNA DI FUCILE**
BLACK NICKEL
-  **.KRD1 > ANTICA FIRENZE**
ANTIQUE FLORENCE
-  **.KRGP > PLACCATO ORO**
GOLD PLATED



linea
Luxury

SERIE 680



GIUSTI



WP0680.045



-	45	62	45

CRISTALLO / CRYSTAL



.KR02> CRISTALLO TRASPARENTE
CRYSTAL TRANSPARENT

WP0680.030



-	30	44	30

FINITURE / FINISHING



.KR02> CROMO LUCIDO
POLISHED CHROME



.KRGP> PLACCATO ORO
GOLD PLATED



linea
Luxury

SERIE 678-679



GIUSTI



WP0678.R45



⌀	↔	↑	↓
-	45	43	45

WP0678.R33



⌀	↔	↑	↓
-	33	32	33

WP0679.E45



⌀	↔	↑	↓
-	45	44	45

WP0679.E33



⌀	↔	↑	↓
-	33	38	33

CRISTALLO / CRYSTAL



.KR02> CRISTALLO TRASPARENTE
CRYSTAL TRANSPARENT

FINITURE / FINISHING



.KR02> CROMO LUCIDO
POLISHED CHROME



.KRGP> PLACCATO ORO
GOLD PLATED



linea
Luxury

SERIE 672
MADE WITH SWAROVSKI® ELEMENTS



WMN672.128



128	155	26	50	

CRISTALLO / CRYSTAL

.KR02 > CRISTALLO TRASPARENTE
CRYSTAL TRANSPARENT
MADE WITH SWAROVSKI® ELEMENTS

FINITURE / FINISHING

- .KR02 > CROMO LUCIDO**
POLISHED CHROME
- .KRM1 > NICHEL LUCIDO**
POLISHED NICKEL
- .KRF7 > VERNICIATO NICHEL SATINATO**
VARNISHED NICKEL SATINED

WMN672.096



96	124	26	45	

- .KRM5 > ARGENTO VENEZIA**
VENETIAN SILVER
- .KRE8 > ARGENTO VECCHIO BRILLANTE**
SHINY OLD SILVER
- .KRA8 > ORVAL**
ORVAL
- .KRD1 > ANTICA FIRENZE**
ANTIQUÉ FLORENCE
- .KRGP > PLACCATO ORO**
GOLD PLATED

WP0672.000



-	38	23	38	



linea
Luxury

SERIE 665
MADE WITH SWAROVSKI® ELEMENTS



GIUSTI



WMN665.096



96	125	23	70	

WMN665.074



74	100	23	58	

CRISTALLO / CRYSTAL

.KR02 > CRISTALLO TRASPARENTE
CRYSTAL TRANSPARENT
MADE WITH SWAROVSKI® ELEMENTS

FINITURE / FINISHING

- .KR02 > CROMO LUCIDO
POLISHED CHROME
- .KRM1 > NICHEL LUCIDO
POLISHED NICKEL
- .KRF7 > VERNICIATO NICHEL SATINATO
VARNISHED NICKEL SATINED

WP0665.000



-	46	23	35	

- .KRM5 > ARGENTO VENEZIA
VENETIAN SILVER
- .KRE8 > ARGENTO VECCHIO BRILLANTE
SHINY OLD SILVER
- .KRA8 > ORVAL
ORVAL
- .KRD1 > ANTICA FIRENZE
ANTIQUÉ FLORENCE
- .KRGP > PLACCATO ORO
GOLD PLATED



linea
Luxury

SERIE 335 KR



GIUSTI



WMN335K320



320	328	28	9

CRISTALLO / CRYSTAL

.KR02 > CRISTALLO TRASPARENTE
CRYSTAL TRANSPARENT

WMN335K128



128	136	28	9

FINITURE / FINISHING

- .KR02 > CROMO LUCIDO
POLISHED CHROME
- .KR03 > NICHEL SATINATO
NICKEL SATINED
- .KRL8 > TOTAL BLACK NICHEL
TOTAL BLACK NICKEL
- .KRGP > PLACCATO ORO
GOLD PLATED

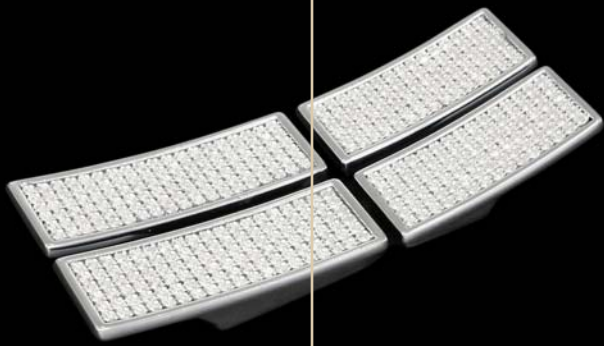

linea
Luxury

SERIE 691 KR



GIUSTI



WMN691.K32

32	25	22	75	



WMN691.K16

16	25	22	58	

CRISTALLO / CRYSTAL

.KR02 > CRISTALLO TRASPARENTE
CRYSTAL TRANSPARENT

FINITURE / FINISHING

.KR02 > CROMO LUCIDO
POLISHED CHROME

.KRF7 > NICHEL SATINATO
NICKEL SATINED

.KRE8 > ARGENTO VECCHIO BRILL.
SHINY OLD SILVER

.KRA8 > ORVAL
ORVAL

.KRGP > PLACCATO ORO
GOLD PLATED



linea
Luxury

SERIE 694
MADE WITH SWAROVSKI® ELEMENTS



GIUSTI



WMN694.160



160	180	25	22	

CRISTALLO / CRYSTAL

.KR02 > CRISTALLO TRASPARENTE
CRYSTAL TRANSPARENT
MADE WITH SWAROVSKI® ELEMENTS

WMN694.128



128	148	24	22	

FINITURE / FINISHING

.KR02 > CROMO LUCIDO
POLISHED CHROME

.KRP9 > NICHEL VELO
NICKEL VELO

WP0694.000

.KRE8 > ARGENTO VECCHIO BRILL.
SHINY OLD SILVER

.KRL8 > TOTAL BLACK NICHEL
TOTAL BLACK NICKEL

.KRA8 > ORVAL
ORVAL

.KRD1 > ANTICA FIRENZE
ANTIQUÉ FLORENCE

.KRGP > PLACCATO ORO
GOLD PLATED



96	116	24	22	



-	30	22	30	



linea
Luxury

SERIE 693
MADE WITH SWAROVSKI® ELEMENTS



GIUSTI

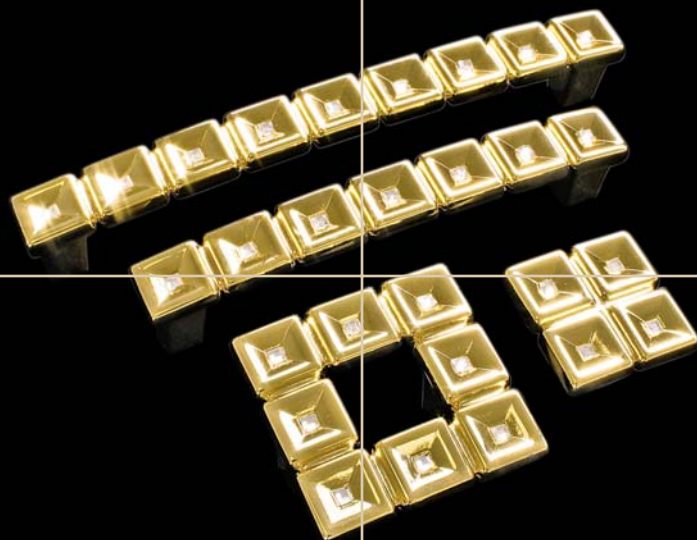

WMN693.128



128	144	24	15

WMN693.096



96	110	24	15

WP0693.015



-	15	21	15

CRISTALLO / CRYSTAL

.KR02 > CRISTALLO TRASPARENTE
CRYSTAL TRANSPARENT
MADE WITH SWAROVSKI® ELEMENTS

FINITURE / FINISHING

.KR02 > CROMO LUCIDO
POLISHED CHROME
 .KR03 > NICHEL SATINATO
NICKEL SATINED

WMN693.032



32	47	23	47

WP0693.031



-	31	21	31

.KRE8 > ARGENTO VECCHIO BRILLANTE
SHINY OLD SILVER
 .KRE2 > CANNA DI FUCILE
BLACK NICKEL
 .KRA8 > ORVAL
ORVAL
 .KRD1 > ANTICA FIRENZE
ANTIQUE FLORENCE
 .KRGP > PLACCATO ORO
GOLD PLATED



linea
Luxury

SERIE 715
MADE WITH SWAROVSKI® ELEMENTS

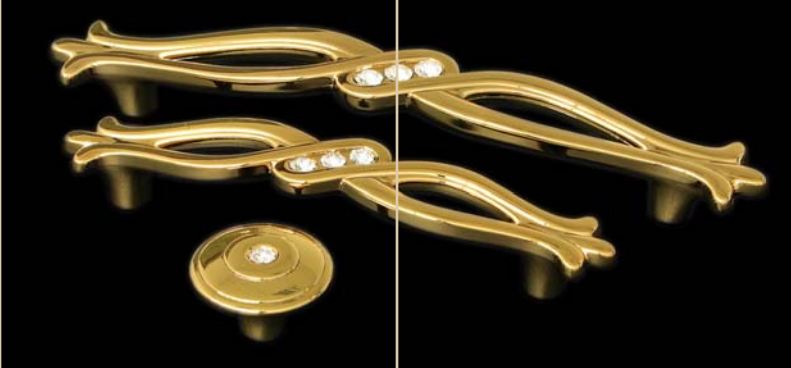

WMN715.128



128	172	25	25

CRISTALLO / CRYSTAL

.KR02 > CRISTALLO TRASPARENTE
CRYSTAL TRANSPARENT
MADE WITH SWAROVSKI® ELEMENTS

FINITURE / FINISHING

- .KRM2 > LACCATO AVORIO LUCIDO**
SHINY IVORY
- .KR02 > CROMO LUCIDO**
POLISHED CHROME
- .KRF7 > VERNICIATO NICHEL SATINATO**
VARNISHED NICKEL SATINED

WMN715.096



96	127	22	20

- .KRM5 > ARGENTO VENEZIA**
VENETIAN SILVER
- .KRE8 > ARGENTO VECCHIO BRILLANTE**
SHINY OLD SILVER
- .KRA8 > ORVAL**
ORVAL
- .KRD1 > ANTICA FIRENZE**
ANTIQUÉ FLORENCE
- .KRGP > PLACCATO ORO**
GOLD PLATED

WP0715.030



-	30	22	30



linea
Luxury

SERIE 716 KR
MADE WITH SWAROVSKI® ELEMENTS



GIUSTI



WMN716.160



160	174	25	30

WMN716.128



128	142	25	30

CRISTALLO / CRYSTAL

.KR02 > CRISTALLO TRASPARENTE
CRYSTAL TRANSPARENT
MADE WITH SWAROVSKI® ELEMENTS

FINITURE / FINISHING

- .KRM2 > LACCATO AVORIO LUCIDO
SHINY IVORY
- .KR02 > CROMO LUCIDO
POLISHED CHROME
- .KRP9 > NICHEL VELO
NICKEL VELO

WMN716.096



96	110	24	30

WP0716.030



-	30	22	30

- .KRM5 > ARGENTO VENEZIA
VENETIAN SILVER
- .KRE8 > ARGENTO VECCHIO BRILLANTE
SHINY OLD SILVER
- .KRA8 > ORVAL
ORVAL
- .KRD1 > ANTICA FIRENZE
ANTIQUE FLORENCE
- .KRG > PLACCATO ORO
GOLD PLATED



linea
Luxury

SERIE 716 MB
WHITE MOTHER OF PEARL



GIUSTI

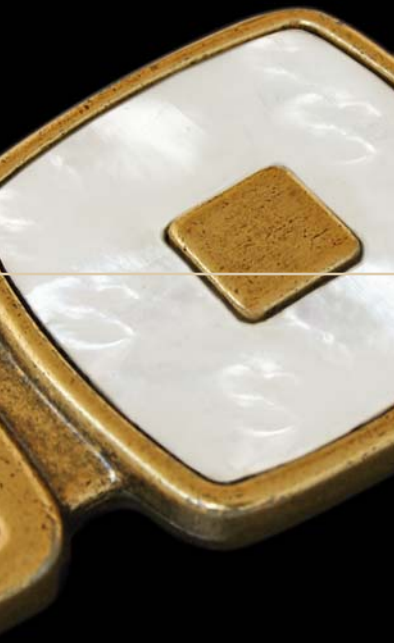

WMN716.160



160	174	25	30

MADREPERLA / MOTHER OF PEARL

.MB02 > MADREPERLA BIANCA
WHITE MOTHER OF PEARL

FINITURE / FINISHING

- .MBM2 > LACCATO AVORIO LUCIDO
SHINY IVORY
- .MB02 > CROMO LUCIDO
POLISHED CHROME
- .MBP9 > NICHEL VELO
NICKEL VELO

WMN716.128



128	142	25	30

- .MBM5 > ARGENTO VENEZIA
VENETIAN SILVER
- .MBE8 > ARGENTO VECCHIO BRILLANTE
SHINY OLD SILVER
- .MBA8 > ORVAL
ORVAL
- .MBD1 > ANTICA FIRENZE
ANTIQUÉ FLORENCE
- .MBGP > PLACCATO ORO
GOLD PLATED

WMN716.096



96	110	24	30

WP0716.030



-	30	22	30

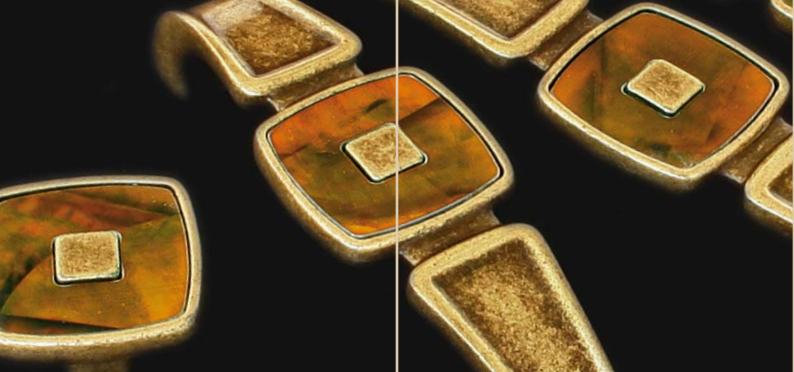

linea
Luxury

SERIE 716 MG
GOLD MOTHER OF PEARL



GIUSTI

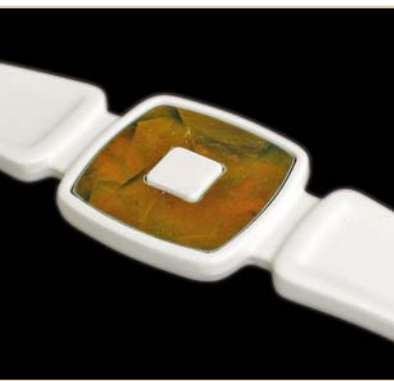

WMN716.160



160	174	25	30

WMN716.128



128	142	25	30

MADREPERLA / MOTHER OF PEARL

.MG02 > MADREPERLA ORO
GOLD MOTHER OF PEARL

FINITURE / FINISHING

.MGM2 > LACCATO AVORIO LUCIDO
SHINY IVORY

.MG02 > CROMO LUCIDO
POLISHED CHROME

.MGP9 > NICHEL VELO
NICKEL VELO

WMN716.096



96	110	24	30

WP0716.030

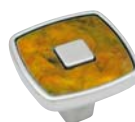

-	30	22	30

.MGM5 > ARGENTO VENEZIA
VENETIAN SILVER

.MGE8 > ARGENTO VECCHIO BRILLANTE
SHINY OLD SILVER

.MGA8 > ORVAL
ORVAL

.MGD1 > ANTICA FIRENZE
ANTIQUE FLORENCE

.MGGP > PLACCATO ORO
GOLD PLATED

INDICE GENERALE

GENERAL INDEX

CODE	LINEA	PAGE	CODE	LINEA	PAGE	CODE	LINEA	PAGE
001	■	022	190	■	042	542	■	075
002	■	034	191	■	042	543	■	075
005	■	013	192	■	049 153	550	■	113 444
005L	■	443	200	■	054	552	■	074
006	■	035	201	■	054	554	■	074
009	■	026	202	■	054	555	■	066
010	■	442	203	■	054	559	■	107
011	■	021	204	■	055	580	■	147
019	■	015	205	■	055	600	■	120
020	■	043	206	■	055	601	■	068
022	■	023	207	■	055	602	■	086 441
025	■	043	208	■	055	603	■	064 237 245
030	■	020	209	■	055	604	■	065
031	■	020	210	■	055	605	■	073
040	■	018 171	211	■	055	606	■	111
101	■	040	212	■	046 154	607	■	081
102	■	040 155	214	■	158	608	■	110 439
105	■	047	215	■	159	609	■	069
106	■	041	216	■	157	610	■	064
107	■	039	218	■	162	611	■	076
108	■	036 067	220	■	156	612	■	063
109	■	067	221	■	160	614	■	089 440
110	■	156 316	222	■	166	615	■	104
111	■	057 067	223	■	155	616	■	062
112 032	■	057 172	224	■	166	619	■	082
112 064	■	057 172	225	■	167	622	■	080
112 160	■	046	226	■	162	624	■	097
114	■	158	227	■	163	625	■	099
115	■	159	228	■	157	626	■	098
116	■	157	229	■	164	627	■	096 245
118	■	162	230	■	164	628	■	077
119	■	014	231	■	158	633	■	112 446
120	■	156 316	232	■	167	634	■	102
122	■	156 316	300	■	016	635	■	091
124	■	050 159	309	■	025	636	■	103
126	■	036	314	■	030	637	■	088
128	■	045 152	317	■	027	638	■	109
130	■	044	329	■	017	639	■	109
132	■	045 153	334	■	019	640	■	072 448
133	■	165	335	■	030	642	■	094
134	■	037 154	335KR	■	456	645	■	092
136	■	038	336	■	033	645K	■	093
138	■	038	400	■	028	646	■	090
139	■	154	401	■	028	647	■	105
140	■	038	402	■	028	648	■	100
142	■	044 152	403	■	029	649	■	101
144	■	046	404	■	029	650	■	070
145	■	037	405	■	029	651	■	071
150	■	052	500	■	161	652	■	078
152	■	042	501	■	161	653	■	085
153	■	041	503	■	079	654	■	083
154	■	040	504	■	165	655	■	119 450
162	■	049	514	■	168	659	■	114
163	■	047	515	■	168	660	■	087
165	■	048	516	■	169	665	■	455
166	■	048	518	■	169 245	666	■	115
169	■	039	532	■	170	661	■	116
170	■	050	533	■	160	662	■	117
180	■	037	534	■	170	667	■	118 451
182	■	039	536	■	095	668	■	136
183	■	047	537	■	095	669	■	122
185	■	046	538	■	106	670	■	121
187	■	024	540	■	075	671	■	135
188	■	061 314	541	■	075	672	■	454

CODE	LINEA	PAGE	CODE	LINEA	PAGE	CODE	LINEA	PAGE
673	■	125	0027	■	300	0512	■	295
674	■	127	0028	■	298	0513	■	294
675	■	123	0029	■	302	0514	■	294
676	■	129	0030	■	302	0515	■	295
678	■	453	0031	■	300	0516	■	295
679	■	453	0034	■	298	0517	■	295
680	■	452	0035	■	298	0518	■	295
682	■	133	0037	■	298	0519	■	295
683	■	130	0038	■	298	0520	■	294
684	■	124	0039	■	298	0521	■	294
685	■	131	0040	■	298	0522	■	297
688	■	126	0046	■	305	0523	■	235
689	■	148	0047	■	305	0524	■	235
691	■	032	0048	■	305	0525	■	297
691KR	■	457	0049	■	305	0526	■	293
692	■	149	0050	■	305	0527	■	292
693	■	459	0051	■	305	0528	■	292
694	■	458	0052	■	305	0529	■	292
695	■	134	0053	■	305	0530	■	292
696	■	128	0054	■	302	0531	■	292
697	■	132	0055	■	302	0532	■	292
700	■	138	0057	■	304	0533	■	292
701	■	139	0058	■	299	0534	■	292
702	■	140	0059	■	299	0535	■	292
703	■	141	0060	■	299	0536	■	292
704	■	137	0061	■	299	0537	■	294
705	■	142	0062	■	299	0538	■	297
706	■	143	0063	■	299	0539	■	297
707	■	144	0064	■	299	0540	■	297
711	■	145	0065	■	299	0541	■	297
712	■	146	0066	■	299	0542	■	293
715	■	460	0067	■	299	0543	■	296
716KR	■	461	0068	■	301	0544	■	296
716MB	■	462	0069	■	301	0545	■	296
716MG	■	463	0070	■	301	0546	■	296
718	■	150	0071	■	301	0547	■	295
719	■	151	0072	■	301	0548	■	295
900	■	075	0073	■	299	0549	■	295
WA0001	■	053	0074	■	299	0550	■	295
0001	■	298	0075	■	299	0551	■	295
0002	■	298	0076	■	302	0552	■	296
0004	■	303	0077	■	302	0553	■	296
0005	■	298	0078	■	302	0554	■	297
0006	■	305	0079	■	303	0555	■	297
0007	■	305	0080	■	303	0556	■	297
0008	■	305	0081	■	303	0557	■	293
0009	■	305	0082	■	303	1003	■	275
0010	■	305	0083	■	303	1004	■	275
0011	■	259	0084	■	303	1005	■	274
0012	■	305	0092	■	260	1006	■	275
0013	■	304	0093	■	260	1007	■	275
0014	■	304	0099	■	305	1008	■	275
0015	■	304	0500	■	292	1009	■	274
0016	■	304	0501	■	296	1010	■	274
0017	■	304	0502	■	296	1012	■	275
0018	■	304	0503	■	296	1013	■	275
0019	■	304	0504	■	294	1014	■	275
0020	■	304	0505	■	294	1015	■	251
0021	■	304	0506	■	294	1016	■	251
0022	■	300	0507	■	294	1017	■	251
0023	■	300	0508	■	294	1018	■	250
0024	■	302	0509	■	295	1020	■	254
0025	■	300	0510	■	295	1021	■	250
0026	■	300	0511	■	295	1022	■	251

INDICE GENERALE

GENERAL INDEX

CODE	LINEA	PAGE	CODE	LINEA	PAGE	CODE	LINEA	PAGE
1022K	■	205	2030	■	260	4048	■	272
1023	■	251	2031	■	175 258	4049	■	272
1024	■	251	2032	■	108 259	4050	■	272
1025	■	251	2050	■	260	4051	■	272
1026	■	251	2051	■	260	4052	■	272
1027	■	252	3000	■	264	4053	■	272
1028	■	252	3001	■	264	4054	■	272
1029	■	252	3002	■	264	4055	■	272
1030	■	253	3003	■	264	4056	■	272
1031	■	253	3004	■	265	4057	■	273
1035	■	250	3005	■	265	4061	■	271
1035K	■	206	3006	■	265	4063	■	271
1036	■	250	3007	■	264	4064	■	271
1036K	■	206	3008	■	264	4065	■	271
1037	■	250	3009	■	264	4066	■	271
1039	■	252	3010	■	265	4068	■	271
1040	■	252	3011	■	266	4069	■	271
1041	■	250	3012	■	266	4070	■	273
1042	■	250	3013	■	266	4071	■	273
1043	■	252	3013BP	■	267	4072	■	273
1044	■	253	3014	■	266	4073	■	273
1046	■	252	3015	■	267	4074	■	273
1048	■	274	3016	■	267	4075	■	273
1049	■	274	3016BP	■	267	4076	■	273
1050	■	274	3017	■	267	4077	■	273
1051	■	252	3018	■	267	4078	■	273
1056	■	254	3019	■	266	4079	■	273
1057	■	275	3020	■	090 266	4080	■	274
1058	■	254	3021	■	267	4081	■	272
1063	■	255	4000	■	268	4082	■	272
1064	■	255	4001	■	268	4083	■	272
1066	■	255	4002	■	268	4084	■	272
1070	■	255	4009	■	269	4086	■	273
1073	■	254	4010	■	269	4087	■	273
1074	■	252	4011	■	269	4088	■	271
1075	■	252	4012	■	269	4089	■	271
1076	■	255	4013	■	269	4091	■	271
1077	■	255	4014	■	269	4092	■	271
2000	■	256	4019	■	269	4093	■	270
2001	■	258	4020	■	269	4094	■	270
2002	■	256	4021	■	269	4095	■	270
2003	■	258	4023	■	270	4096	■	270
2004	■	257	4024	■	270	4097	■	270
2005	■	257	4025	■	270	4098	■	270
2006	■	262	4026	■	270	4099	■	270
2007	■	258	4027	■	270	4100	■	270
2008	■	262	4028	■	270	4101	■	271
2009	■	263	4029	■	268	4102	■	271
2010	■	263	4030	■	268	4103	■	271
2011	■	262	4032	■	268	4104	■	274
2012	■	263	4033	■	268	4105	■	274
2015	■	257	4034	■	268	4106	■	290
2016	■	257	4035	■	268	4107	■	275
2017	■	257	4036	■	268	5000	■	210
2018	■	256	4037	■	268	5001	■	214
2019	■	256	4038	■	269	5002	■	213
2022	■	258	4039	■	269	5003	■	212
2023	■	259	4041	■	269	5004	■	220
2024	■	056 174 259	4042	■	269	5005	■	221
2025	■	056 175 259	4043	■	269	5006	■	221
2026	■	261	4044	■	269	5007	■	209
2027	■	260	4045	■	269	5009	■	224
2028	■	096 261	4046	■	269	5010	■	198
2029	■	261	4047	■	269	5011	■	198

CODE	LINEA	PAGE	CODE	LINEA	PAGE	CODE	LINEA	PAGE
5012	█	224	5105	█	185	6005	█	235
5013	█	220	5106	█	185	6006	█	230
5014	█	200	5107	█	193	6007	█	235
5015	█	182	5108	█	193	6008	█	056 231
5016	█	183	5112	█	181	6009	█	229
5017	█	200	5113	█	181	6010	█	228
5018	█	220	5115	█	180	6011	█	231
5019	█	225	5118	█	179	6012	█	235
5020	█	202	5120	█	187	6014	█	228
5021	█	182	5121	█	187	6015	█	228
5022	█	204	5122	█	187	6016	█	056 174 231
5023	█	207	5123	█	187	6017	█	231
5025	█	205	5124	█	193	6018	█	231
5026	█	196	5125	█	193	6022	█	230
5027	█	203	5126	█	193	6102	█	234
5028	█	203	5127	█	193	6200	█	084
5029	█	179	5128	█	181	7000	█	237
5030	█	173 218	5129	█	181	7001	█	237
5031	█	173 218	5130	█	181	7002	█	239
5032	█	206	5131	█	181	7003	█	238
5033	█	201	5132	█	184	7004	█	238
5034	█	183	5133	█	180	7005	█	236
5035	█	212	5134	█	196	7005TC	█	236
5036	█	210	5135	█	188	7006	█	239
5037	█	212	5136	█	185	7007	█	236
5038	█	202	5137	█	185	7007TC	█	236
5039	█	186	5138	█	185	7008	█	239
5040	█	192	5139	█	185	7009	█	239
5041	█	217	5140	█	186	7009TC	█	236
5042	█	223	5141	█	192	7010	█	237
5043	█	216	5143	█	194	7011	█	236
5044	█	216	5144	█	180	7012	█	236
5045	█	221	5146	█	187	7013	█	237
5046	█	222	5147	█	187	7014	█	237
5047	█	218	5148	█	187	7015	█	237
5048	█	215	5149	█	187	7016	█	237
5049	█	214	5190	█	206	7017	█	238
5050	█	211	5195	█	206	7018	█	238
5051	█	217	5197	█	208	7020	█	238
5052	█	210	5198	█	208	7021	█	237
5053	█	192	5199	█	205	7022	█	238
5054	█	225	5200	█	205	7023	█	239
5055	█	188	5202	█	208	7024	█	239
5057	█	196	5203	█	208	7095	█	239
5058	█	191	5205	█	206	7097	█	238
5059	█	191	5206	█	206	7098	█	237
5060	█	191	5208	█	207	7098TC	█	236
5072	█	163 219	5210	█	207	7112	█	051 172 236
5074	█	213	5212	█	190	7115	█	169 293
5075	█	204	5214	█	190	7200	█	084 238 440
5077	█	222	5216	█	190	7201	█	081 238
5079	█	223	5218	█	190	8000	█	242
5080	█	204	5220	█	190	8001	█	242
5081	█	204	5230	█	051 173 218	8002	█	242
5090	█	051 173 219	5238	█	171	8003	█	242
5091	█	173 219	5239	█	171	8004	█	242
5092	█	173 219	5248	█	201	8005	█	245
5094	█	173 218	5500	█	084	8006	█	245
5095	█	209	5600	█	218	8007	█	245
5096	█	209	6000	█	057 174 230	8008	█	245
5101	█	194	6001	█	234	8009	█	245
5102	█	184	6002	█	057 230	8010	█	245
5103	█	185	6003	█	234	8011	█	245
5104	█	185	6004	█	229	8012	█	244

INDICE GENERALE

GENERAL INDEX

CODE	LINEA	PAGE	CODE	LINEA	PAGE	CODE	LINEA	PAGE
8013	■	244	8076	■	243	9015	■	282
8014	■	242	8077	■	243	9016	■	284
8015	■	242	8078	■	243	9017	■	284
8016	■	242	8079	■	243	9018	■	280
8017	■	243	8080	■	243	9019	■	280
8018	■	243	8081	■	247	9020	■	280
8019	■	244	8082	■	247	9021	■	280
8020	■	244	8083	■	247	9022	■	286
8021	■	244	8084	■	247	9023	■	281
8022	■	244	8085	■	242	9024	■	280
8023	■	244	8086	■	247	9025	■	279
8024	■	244	8087	■	244	9026	■	279
8025	■	244	8088	■	247	9027	■	279
8026	■	244	8089	■	247	9028	■	282
8027	■	241	8090	■	245	9029	■	285
8028	■	241	8091	■	247	9030	■	285
8029	■	241	8092	■	247	9031	■	289
8030	■	241	8093	■	246	9032	■	289
8031	■	244	8094	■	246	9033	■	289
8032	■	245	8095	■	243	9034	■	288
8033	■	245	8096	■	240	9035	■	288
8034	■	245	8098	■	246	9036	■	288
8035	■	241	8100	■	246	9037	■	288
8036	■	241	8101	■	246	9038	■	288
8037	■	241	8102	■	246	9039	■	288
8037SP	■ ■ ■	086 241 440	8103	■	246	9041	■	289
8038	■	241	8104	■	247	9043	■	289
8039	■	241	8105	■	246	9044	■	283
8040	■	241	8110	■	246	9500	■	290
8041	■	241	8111	■	246	9501	■	290
8042	■	241	8112	■	247	9502	■	290
8043	■	241	8113	■	247	39039	■	172
8044	■	241	8114	■	247	39045	■	172
8045	■	241	8115	■	247	2D32	■	218
8046	■	241	8116	■	246	3D48	■	218
8047	■	241	8117	■	246	M01	■	334
8048	■	241	8118	■	247	M01.01.00.04	■	419
8049	■	240	8119	■	247	M01.01.00.15	■	419
8050	■	240	8120	■	247	M01.01.00.15G	■	362
8051	■	240	8121	■	247	M01.01.00.B1G	■	362
8052	■	240	8122	■	244	M01.01.00.C1G	■	362
8053	■	240	8130	■	241	M01.01.00.C2G	■	362
8054	■	240	8131	■	241	M01.01.00.D1G	■	362
8055	■	240	8132	■	241	M01.01.01.D1G	■	362
8056	■	240	8133	■	241	M01.01.02.04	■	419
8057	■	240	8134	■	241	M01.01.02.D1G	■	363
8058	■	243	8135	■	241	M01.01.04.04	■	419
8059	■	240	8180	■ ■ ■	051 172 245	M01.01.05.04	■	419
8060	■	240	8200	■ ■ ■	084 245	M01.01.08.04	■	419
8061	■	240	8201	■ ■ ■	069 245	M01.01.12.04	■	419
8062	■	240	8203	■	244	M01.01.12.D1G	■	363
8063	■	241	9000	■	276	M01.01.81.04	■	418
8064	■	241	9001	■	276	M01.01.81.C1G	■	362
8065	■	241	9002	■	277	M01.01.81.C2G	■	362
8066	■	241	9003	■	277	M01.01.81.D1G	■	362
8067	■	240	9004	■	276	M01.01.91.D1G	■	362
8068	■	243	9005	■	277	M01.01.A1.D1G	■	363
8069	■	243	9006	■	278	M01.01.A4.C1G	■	363
8070	■	243	9007	■	278	M01.01.A4.D1G	■	363
8071	■	243	9008	■	278	M01.01.A7.15G	■	363
8072	■	243	9010	■	288	M01.01.A7.C2G	■	362
8073	■	243	9012	■	287	M01.01.B1.15G	■	363
8074	■	243	9013	■	283	M01.01.113.15G	■	363
8075	■	243	9014	■	283	M01.01.115.D1G	■	363

CODE	LINEA	PAGE	CODE	LINEA	PAGE	CODE	LINEA	PAGE
M01.02.00.01	■	426	M09.01.B1.B1G	■	365	M11.10.00.D1G	■	375
M01.02.01.01	■	428	M09.01.B1.C2G	■	365	M12	■	335
M01.02.02.01	■	427	M09.01.B1.D1G	■	365	M12.01.00.15G	■	388
M01.02.03.01	■	427	M09.10.00.D1G	■	364	M12.01.00.C1G	■	388
M01.02.05.01	■	428	M09.21.A5.D1G	■	364	M12.01.00.C2G	■	388
M01.02.12.01	■	428	M10	■	337	M12.01.00.D1G	■	388
M01.02.20.01	■	428	M10.01.00.04	■	421	M12.01.01.15G	■	388
M01.02.71.15G	■	362	M10.01.00.15	■	421	M12.01.01.D1G	■	388
M01.10.00.15G	■	363	M10.01.00.15G	■	360	M12.01.02.C2G	■	388
M01.10.00.B1G	■	363	M10.01.00.C2G	■	360	M12.01.02.D1G	■	388
M01.10.00.D1G	■	363	M10.01.00.D1G	■	360	M12.01.25.15G	■	389
M02	■	419	M10.01.01.04	■	421	M12.01.81.C1G	■	389
M02.01.00.04	■	419	M10.01.02.04	■	421	M12.01.81.C2G	■	389
M02.01.01.04	■	419	M10.01.02.15G	■	361	M12.01.81.D1G	■	389
M07	■	334	M10.01.02.D1G	■	361	M12.01.A4.15G	■	388
M07.01.00.15G	■	390	M10.01.12.04	■	421	M12.01.A4.C1G	■	388
M07.01.00.B1G	■	390	M10.01.12.C1G	■	360	M12.01.A4.C2G	■	388
M07.01.00.C1G	■	390	M10.01.12.C2G	■	360	M12.01.A4.D1G	■	388
M07.01.00.C2G	■	390	M10.01.51.04	■	421	M12.01.B1.15G	■	389
M07.01.00.D1G	■	390	M10.01.81.04	■	421	M12.01.B1.D1G	■	389
M07.01.02.B1G	■	390	M10.01.81.D1G	■	360	M12.01.B4.D1G	■	389
M07.01.02.D1G	■	390	M10.01.90.15G	■	360	M12.01.115.D1G	■	389
M07.01.12.15G	■	391	M10.01.A1.D1G	■	361	M12.10.00.15G	■	389
M07.01.12.D1G	■	390	M10.01.A4.D1G	■	360	M12.10.00.C2G	■	389
M07.01.81.C1G	■	390	M10.01.B1.15G	■	361	M12.10.00.D1G	■	389
M07.01.81.D1G	■	390	M10.01.B1.C1G	■	361	M12.21.A5.D1G	■	389
M07.01.A1.D1G	■	391	M10.01.B1.C2G	■	361	M16	■	335
M07.01.A4.15G	■	391	M10.01.B4.D1G	■	361	M16.01.00.15G	■	380
M07.01.A4.B1G	■	391	M10.01.115.04	■	421	M16.01.00.C2G	■	380
M07.01.A4.C1G	■	391	M10.01.115.15G	■	361	M16.01.00.D1G	■	380
M07.01.A4.D1G	■	391	M10.01.115.C1G	■	361	M16.01.01.15G	■	380
M07.01.B1.15G	■	390	M10.02.00.C1G	■	360	M16.01.01.D1G	■	380
M07.01.B1.D1G	■	390	M10.02.25.C2G	■	360	M16.01.81.04	■	418
M07.01.113.15G	■	391	M10.02.68.C1G	■	360	M16.01.81.D1G	■	380
M07.01.113.D1G	■	391	M10.02.113.15G	■	360	M16.01.A1.D1G	■	380
M07.01.115.C1G	■	391	M10.10.00.01	■	426	M16.01.B1.15G	■	380
M07.01.115.D1G	■	391	M10.10.00.B1G	■	361	M16.01.B1.D1G	■	380
M07.10.00.B1G	■	391	M10.10.00.D1G	■	361	M16.01.113.15G	■	380
M07.10.00.D1G	■	391	M10.21.A5.D1G	■	361	M16.01.113.D1G	■	380
M09	■	334	M11	■	334	M16.10.00.D1G	■	380
M09.01.00.04	■	420	M11.01.00.15G	■	374	M17	■	335
M09.01.00.15	■	420	M11.01.00.B1G	■	374	M17.01.00.04	■	419
M09.01.00.15G	■	364	M11.01.00.C2G	■	374	M17.01.00.15G	■	366
M09.01.00.C2G	■	364	M11.01.00.D1G	■	374	M17.01.00.B1G	■	366
M09.01.00.D1G	■	364	M11.01.04.15G	■	375	M17.01.00.C1G	■	366
M09.01.01.04	■	420	M11.01.04.C1G	■	375	M17.01.00.C2G	■	366
M09.01.01.D1G	■	365	M11.01.04.D1G	■	375	M17.01.00.D1G	■	366
M09.01.02.04	■	420	M11.01.81.04	■	418	M17.01.02.04	■	419
M09.01.02.D1G	■	365	M11.01.81.D1G	■	374	M17.01.02.15G	■	367
M09.01.04.C1G	■	364	M11.01.90.15G	■	374	M17.01.02.27	■	425
M09.01.04.D1G	■	364	M11.01.90.C1G	■	374	M17.01.02.D1G	■	367
M09.01.25.15G	■	364	M11.01.90.D1G	■	374	M17.01.12.15G	■	367
M09.01.81.04	■	420	M11.01.91.15G	■	375	M17.01.12.D1G	■	367
M09.01.81.15G	■	364	M11.01.91.B1G	■	375	M17.01.81.04	■	418
M09.01.81.D1G	■	364	M11.01.91.D1G	■	375	M17.01.81.C1G	■	366
M09.01.91.15G	■	365	M11.01.A1.D1G	■	374	M17.01.81.C2G	■	366
M09.01.91.D1G	■	365	M11.01.A5.D1G	■	374	M17.01.81.D1G	■	366
M09.01.A4.C1G	■	364	M11.01.A7.15G	■	375	M17.01.A1.D1G	■	366
M09.01.A4.D1G	■	364	M11.01.A7.B1G	■	375	M17.01.A4.D1G	■	366
M09.01.A7.15G	■	365	M11.01.A7.C2G	■	375	M17.01.A7.15G	■	367
M09.01.A7.C1G	■	365	M11.01.A7.D1G	■	375	M17.01.A7.C1G	■	367
M09.01.A7.C2G	■	365	M11.01.113.C2G	■	374	M17.01.A7.C2G	■	367
M09.01.A7.D1G	■	365	M11.01.113.D1G	■	374	M17.01.A7.D1G	■	367
M09.01.B1.15G	■	365	M11.10.00.C2G	■	375	M17.01.B1.15G	■	367

INDICE GENERALE

GENERAL INDEX

CODE	LINEA	PAGE	CODE	LINEA	PAGE	CODE	LINEA	PAGE
M17.01.B1.C2G	■	367	M22.01.91.C2G	■	384	M27.01.115.C1G	■	387
M17.01.B1.D1G	■	367	M22.01.91.D1G	■	384	M27.01.115.D1G	■	387
M17.01.113.15G	■	366	M22.01.A4.15G	■	384	M27.10.00.15G	■	387
M17.01.115.D1G	■	366	M22.01.A4.C2G	■	385	M27.10.00.D1G	■	387
M17.10.00.D1G	■	367	M22.01.A4.D1G	■	384	M27.21.A5.D1G	■	387
M19	■	335	M22.01.A5.D1G	■	384	M28	■	337
M19.01.00.04	■	422	M22.01.A7.15G	■	385	M28.01.00.15G	■	377
M19.01.00.15	■	422	M22.01.A7.C2G	■	385	M28.01.00.B1G	■	377
M19.01.00.15G	■	372	M22.01.A7.D1G	■	385	M28.01.00.C1G	■	377
M19.01.00.C1G	■	372	M22.01.113.15G	■	385	M28.01.00.C2G	■	377
M19.01.00.C2G	■	372	M22.01.113.C1G	■	385	M28.01.00.D1G	■	377
M19.01.00.D1G	■	372	M22.01.113.C2G	■	385	M28.01.81.C2G	■	377
M19.01.02.04	■	422	M22.01.113.D1G	■	385	M28.01.81.D1G	■	377
M19.01.02.D1G	■	373	M22.01.115.C1G	■	385	M28.01.A5.D1G	■	377
M19.01.03.27	■	425	M22.01.115.D1G	■	385	M28.01.A7.C2G	■	377
M19.01.05.15	■	422	M22.01.124.15G	■	385	M28.01.A7.D1G	■	377
M19.01.12.D1G	■	373	M22.10.00.D1G	■	385	M28.10.00.D1G	■	377
M19.01.20.04	■	422	M24	■	336	M28.21.A5.D1G	■	377
M19.01.25.15G	■	373	M24.01.00.15G	■	378	M50	■	334
M19.01.81.04	■	422	M24.01.00.D1G	■	378	M50.01.00.04	■	424
M19.01.81.C1G	■	372	M24.01.01.D1G	■	378	M50.01.00.15	■	425
M19.01.81.C2G	■	372	M24.01.81.C2G	■	378	M50.01.00.15G	■	382
M19.01.81.D1G	■	372	M24.01.81.D1G	■	378	M50.01.00.C1G	■	382
M19.01.A1.D1G	■	372	M24.01.91.15G	■	378	M50.01.00.C2G	■	382
M19.01.A4.B1G	■	372	M24.01.91.D1G	■	378	M50.01.00.D1G	■	382
M19.01.A4.D1G	■	372	M24.01.A7.15G	■	378	M50.01.01.04	■	424
M19.01.A7.15G	■	373	M24.01.A7.D1G	■	378	M50.01.01.15G	■	383
M19.01.A7.C1G	■	373	M24.01.B1.D1G	■	378	M50.01.01.27	■	425
M19.01.A7.C2G	■	373	M24.10.00.D1G	■	378	M50.01.01.D1G	■	383
M19.01.A7.D1G	■	373	M24.21.A5.D1G	■	378	M50.01.02.04	■	425
M19.01.B1.C2G	■	373	M25	■	336	M50.01.02.D1G	■	383
M19.01.B1.D1G	■	373	M26	■	336	M50.01.12.04	■	424
M19.01.115.C1G	■	372	M26.01.00.C2G	■	370	M50.01.12.D1G	■	383
M19.01.115.D1G	■	372	M26.01.00.D1G	■	370	M50.01.25.15	■	425
M19.10.00.15G	■	373	M26.01.02.D1G	■	370	M50.01.81.04	■	424
M19.10.00.C2G	■	373	M26.01.04.15G	■	370	M50.01.81.C1G	■	382
M19.10.00.D1G	■	373	M26.01.04.C2G	■	370	M50.01.81.D1G	■	382
M20.01.00.04	■	422	M26.01.04.D1G	■	370	M50.01.A1.D1G	■	382
M20.01.00.15	■	422	M26.01.81.D1G	■	370	M50.01.A4.15G	■	382
M21	■	335	M26.01.A5.D1G	■	370	M50.01.A4.C1G	■	382
M21.01.00.15G	■	379	M26.01.A7.15G	■	370	M50.01.A4.D1G	■	382
M21.01.00.C2G	■	379	M26.01.A7.C2G	■	370	M50.01.A7.15G	■	383
M21.01.00.D1G	■	379	M26.01.A7.D1G	■	370	M50.01.A7.C1G	■	383
M21.01.02.D1G	■	379	M26.10.00.D1G	■	370	M50.01.A7.C2G	■	383
M21.01.04.D1G	■	379	M27	■	336	M50.01.A7.D1G	■	383
M21.01.12.15G	■	379	M27.01.00.15G	■	386	M50.01.B1.15G	■	382
M21.01.12.D1G	■	379	M27.01.00.B1G	■	386	M50.01.B1.D1G	■	382
M21.01.81.04	■	418	M27.01.00.C1G	■	386	M50.01.115.C1G	■	383
M21.01.81.D1G	■	379	M27.01.00.C2G	■	386	M50.01.115.D1G	■	383
M21.01.A5.D1G	■	379	M27.01.00.D1G	■	386	M50.10.00.B1G	■	383
M21.01.B1.D1G	■	379	M27.01.01.15G	■	386	M50.10.00.D1G	■	383
M21.10.00.D1G	■	379	M27.01.01.C1G	■	386	M51	■	337
M21.21.A5.D1G	■	379	M27.01.01.C2G	■	386	M51.01.00.04	■	423
M22	■	336	M27.01.01.D1G	■	386	M51.01.00.15	■	423
M22.01.00.04	■	423	M27.01.12.D1G	■	387	M51.01.00.15G	■	392
M22.01.00.15G	■	384	M27.01.81.15G	■	386	M51.01.00.B1G	■	392
M22.01.00.C1G	■	384	M27.01.81.C2G	■	386	M51.01.00.C1G	■	392
M22.01.00.C2G	■	384	M27.01.81.D1G	■	386	M51.01.00.C2G	■	392
M22.01.00.D1G	■	384	M27.01.A5.D1G	■	387	M51.01.00.D1G	■	392
M22.01.51.04	■	423	M27.01.A7.15G	■	387	M51.01.02.04	■	423
M22.01.81.04	■	423	M27.01.A7.B1G	■	387	M51.01.02.D1G	■	393
M22.01.81.C1G	■	384	M27.01.A7.D1G	■	387	M51.01.04.D1G	■	393
M22.01.81.D1G	■	384	M27.01.B1.D1G	■	387	M51.01.11.04	■	423
M22.01.91.15G	■	384	M27.01.115.B1G	■	387	M51.01.12.04	■	423

CODE	LINEA	PAGE	CODE	LINEA	PAGE	CODE	LINEA	PAGE
M51.01.12.D1G	■	393	M54.01.113.15G	■	357	M62.01.A1.D1G	■	312
M51.01.25.15G	■	393	M54.01.113.C1G	■	357	M62.01.A4.D1G	■	312
M51.01.81.04	■	418	M54.01.113.C2G	■	357	M62.01.B4.D1G	■	312
M51.01.81.15G	■	393	M54.01.113.D1G	■	356	M63	■	338
M51.01.81.C2G	■	393	M54.01.115.15G	■	357	M63.00.00.D1G	■	315
M51.01.81.D1G	■	393	M54.01.115.D1G	■	357	M63.00.00.E8G	■	315
M51.01.A1.D1G	■	392	M54.02.00.15G	■	359	M63.00.00.F7G	■	315
M51.01.A4.15G	■	392	M54.02.00.C2G	■	359	M63.01.00.D1G	■	315
M51.01.A4.C1G	■	392	M54.02.00.D1G	■	359	M63.01.00.E8G	■	315
M51.01.A4.D1G	■	392	M54.02.A7.C2G	■	358	M63.01.00.F7G	■	315
M51.01.A7.15G	■	393	M54.02.B1.C2G	■	357	M63.07.00.D1G	■	315
M51.01.A7.D1G	■	393	M54.10.00.15G	■	359	M63.07.00.E8G	■	315
M51.01.B1.C2G	■	393	M54.10.00.C1G	■	359	M63.07.00.F7G	■	315
M51.01.B1.D1G	■	393	M54.10.00.C2G	■	359	M63.24.00.D1G	■	315
M51.01.113.D1G	■	393	M54.10.00.D1G	■	359	M63.24.00.E8G	■	315
M51.01.115.15G	■	392	M54.21.A5.D1G	■	359	M63.24.00.F7G	■	315
M51.01.115.D1G	■	392	M55	■	338	M70	■	338
M51.10.00.D1G	■	392	M55.00.00.E8G	■	309	M70.00.F7.M5G	■	318
M53	■	337	M55.00.00.F7G	■	309	M70.00.F7.R3G	■	395
M53.01.00.15G	■	376	M55.00.C3.CRG	■	309	M70.00.G3.F7G	■	395
M53.01.00.B1G	■	376	M55.00.C5.E8G	■	309	M70.00.G8.E8G	■	395
M53.01.00.C1G	■	376	M55.00.D4.CRG	■	309	M70.00.H4.CRG	■	395
M53.01.00.C2G	■	376	M55.01.00.D1G	■	309	M70.00.H4.M5G	■	395
M53.01.00.D1G	■	376	M55.01.00.E8G	■	309	M70.01.F1.R4G	■	394
M53.01.81.C2G	■	376	M55.01.B6.D1G	■	309	M70.01.F3.E8G	■	395
M53.01.81.D1G	■	376	M55.01.C3.F7G	■	309	M70.01.F6.A8G	■	318
M53.01.A5.D1G	■	376	M55.01.C5.F7G	■	309	M70.01.F8.C1G	■	394
M53.01.A7.C2G	■	376	M55.01.D4.E8G	■	309	M70.01.F8.M5G	■	395
M53.01.A7.D1G	■	376	M55.01.D4.F7G	■	309	M70.01.G1.B1G	■	395
M53.10.00.D1G	■	376	M55.01.D5.D1G	■	309	M70.01.G1.D1G	■	394
M53.21.A5.D1G	■	376	M55.07.00.F7G	■	309	M70.01.G2.A8G	■	394
M54	■	337	M55.07.B7.CRG	■	309	M70.01.G4.R4G	■	394
M54.01.00.15G	■	356	M55.07.B7.E8G	■	309	M70.01.G6.D1G	■	394
M54.01.00.C1G	■	356	M55.07.C8.D1G	■	309	M70.01.G6.E8G	■	318
M54.01.00.C2G	■	356	M55.07.D2.CRG	■	309	M70.01.G7.A8G	■	394
M54.01.00.D1G	■	356	M55.23.D1.E8G	■	309	M70.01.G9.A8G	■	394
M54.01.01.15G	■	358	M56	■	338	M70.01.G9.C2G	■	318 395
M54.01.01.D1G	■	358	M56.00.00.CRG	■	310	M70.01.G9.R3G	■	395
M54.01.02.15G	■	359	M56.00.B9.CRG	■	310	M70.01.H2.D1G	■	394
M54.01.02.D1G	■	359	M56.00.B9.F7G	■	310	M70.01.H2.T5G	■	318
M54.01.04.15G	■	359	M56.00.C6.CRG	■	310	M70.01.H3.D1G	■	394
M54.01.04.D1G	■	359	M56.00.C6.F7G	■	310	M70.01.H3.R4G	■	318
M54.01.12.15G	■	356	M56.00.XX.CRG	■	311	M70.01.H5.C2G	■	395
M54.01.12.D1G	■	356	M56.00.XX.E8G	■	311	M70.01.H5.D1G	■	318 394
M54.01.25.15G	■	358	M56.00.XX.F7G	■	311	M70.01.H5.E8G	■	395
M54.01.81.15G	■	357	M56.01.00.D1G	■	310	M70.01.H7.D1G	■	394
M54.01.81.C1G	■	357	M56.01.00.E8G	■	310	M71	■	339
M54.01.81.C2G	■	357	M56.01.00.F7G	■	310	M71.00.F7.CRG	■	319
M54.01.81.D1G	■	357	M56.01.B8.D1G	■	310	M71.00.F7.R3G	■	397
M54.01.90.15G	■	356	M56.01.C1.D1G	■	310	M71.00.G3.F7G	■	397
M54.01.90.D1G	■	356	M56.01.C7.D1G	■	310	M71.00.G3.T4G	■	319
M54.01.91.15G	■	358	M56.01.XX.CRG	■	311	M71.00.G8.E8G	■	397
M54.01.91.D1G	■	358	M56.01.XX.D1G	■	311	M71.00.H4.CRG	■	397
M54.01.A1.D1G	■	358	M56.01.XX.E8G	■	311	M71.00.H4.M5G	■	397
M54.01.A4.15G	■	356	M56.01.XX.F7G	■	311	M71.01.F1.R4G	■	396
M54.01.A4.C1G	■	356	M56.07.XX.CRG	■	311	M71.01.F3.E8G	■	397
M54.01.A4.D1G	■	356	M56.07.XX.E8G	■	311	M71.01.F5.D1G	■	319
M54.01.A5.D1G	■	358	M56.07.XX.F7G	■	311	M71.01.F8.C1G	■	396
M54.01.A7.15G	■	358	M56.XX	■	311	M71.01.F8.M5G	■	397
M54.01.A7.C1G	■	358	M62	■	338	M71.01.G1.B1G	■	397
M54.01.A7.D1G	■	358	M62.01.00.15G	■	312	M71.01.G1.D1G	■	396
M54.01.B1.15G	■	357	M62.01.00.D1G	■	312	M71.01.G2.A8G	■	396
M54.01.B1.D1G	■	357	M62.01.81.D1G	■	312	M71.01.G4.A8G	■	319
M54.01.B4.D1G	■	358	M62.01.90.15G	■	312	M71.01.G4.R4G	■	396

INDICE GENERALE

GENERAL INDEX

CODE	LINEA	PAGE	CODE	LINEA	PAGE	CODE	LINEA	PAGE
M71.01.G6.D1G	■	396	M73.01.G9.C2G	■	401	M75.01.H5.C2G	■	405
M71.01.G7.A8G	■	396	M73.01.G9.R3G	■	401	M75.01.H5.D1G	■	404
M71.01.G9.A8G	■	396	M73.01.H2.D1G	■	400	M75.01.H5.E8G	■	405
M71.01.G9.C2G	■	397	M73.01.H3.D1G	■	400	M75.01.H5.T5G	■	323
M71.01.G9.GPG	■	319	M73.01.H5.C2G	■	401	M75.01.H7.D1G	■	404
M71.01.G9.R3G	■	397	M73.01.H5.D1G	■	321	M76	■	340
M71.01.H2.D1G	■	396	M73.01.H5.E8G	■	401	M76.00.F7.R3G	■	407
M71.01.H3.D1G	■	396	M73.01.H7.C1G	■	321	M76.00.G3.F7G	■	407
M71.01.H3.R4G	■	319	M73.01.H7.D1G	■	400	M76.00.G8.E8G	■	407
M71.01.H5.C2G	■	397	M74	■	339	M76.00.H4.CRG	■	324
M71.01.H5.D1G	■	396	M74.00.F7.R3G	■	403	M76.00.H4.M5G	■	407
M71.01.H5.E8G	■	319	M74.00.G3.F7G	■	403	M76.01.F1.R4G	■	406
M71.01.H7.D1G	■	396	M74.00.G8.E8G	■	403	M76.01.F3.C2G	■	324
M72	■	339	M74.00.G8.R3G	■	322	M76.01.F3.E8G	■	407
M72.00.F7.M5G	■	320	M74.00.H4.CRG	■	403	M76.01.F8.C1G	■	406
M72.00.F7.R3G	■	399	M74.00.H4.E8G	■	322	M76.01.F8.M5G	■	407
M72.00.G3.F7G	■	399	M74.00.H4.M5G	■	403	M76.01.F8.R4G	■	324
M72.00.G8.E8G	■	399	M74.01.F1.R4G	■	402	M76.01.G1.B1G	■	407
M72.00.H4.CRG	■	399	M74.01.F3.E8G	■	403	M76.01.G1.D1G	■	406
M72.00.H4.M5G	■	399	M74.01.F8.A8G	■	322	M76.01.G2.A8G	■	406
M72.00.H4.R3G	■	320	M74.01.F8.C1G	■	402	M76.01.G4.R4G	■	406
M72.01.F1.R4G	■	398	M74.01.F8.M5G	■	403	M76.01.G6.D1G	■	406
M72.01.F3.E8G	■	399	M74.01.G1.B1G	■	403	M76.01.G7.A8G	■	406
M72.01.F3.GPG	■	320	M74.01.G1.D1G	■	402	M76.01.G9.A8G	■	406
M72.01.F8.C1G	■	398	M74.01.G2.A8G	■	402	M76.01.G9.C1G	■	324
M72.01.F8.M5G	■	399	M74.01.G4.R4G	■	402	M76.01.G9.C2G	■	407
M72.01.G1.B1G	■	399	M74.01.G6.B1G	■	322	M76.01.G9.R3G	■	407
M72.01.G1.D1G	■	398	M74.01.G6.D1G	■	402	M76.01.H2.D1G	■	406
M72.01.G2.A8G	■	398	M74.01.G7.A8G	■	402	M76.01.H2.E8G	■	324
M72.01.G4.R4G	■	398	M74.01.G7.R4G	■	322	M76.01.H3.A8G	■	324
M72.01.G6.D1G	■	320	M74.01.G9.A8G	■	402	M76.01.H3.D1G	■	406
M72.01.G7.A8G	■	398	M74.01.G9.C2G	■	403	M76.01.H5.C2G	■	407
M72.01.G7.T5G	■	320	M74.01.G9.R3G	■	403	M76.01.H5.D1G	■	406
M72.01.G9.A8G	■	398	M74.01.H2.D1G	■	402	M76.01.H5.E8G	■	407
M72.01.G9.C2G	■	399	M74.01.H3.D1G	■	322	M76.01.H7.D1G	■	324
M72.01.G9.R3G	■	399	M74.01.H5.C2G	■	322	M77	■	406
M72.01.H2.D1G	■	398	M74.01.H5.D1G	■	402	M77.00.F7.R3G	■	340
M72.01.H3.A8G	■	320	M74.01.H5.E8G	■	402	M77.00.F7.R3G	■	409
M72.01.H3.D1G	■	398	M74.01.H7.D1G	■	403	M77.00.G3.E8G	■	325
M72.01.H5.C2G	■	320	M75	■	339	M77.00.G3.F7G	■	409
M72.01.H5.D1G	■	398	M75.00.F7.R3G	■	405	M77.00.G8.E8G	■	409
M72.01.H5.E8G	■	399	M75.00.G3.F7G	■	405	M77.00.H4.CRG	■	409
M72.01.H7.D1G	■	398	M75.00.G3.M5G	■	323	M77.00.H4.CRG	■	409
M73	■	339	M75.00.G8.E8G	■	405	M77.01.F1.R4G	■	408
M73.00.F2.CRG	■	321	M75.00.H4.CRG	■	405	M77.01.F3.E8G	■	409
M73.00.F7.R3G	■	401	M75.00.H4.M5G	■	405	M77.01.F5.T5G	■	325
M73.00.G3.F7G	■	401	M75.01.F1.A8G	■	405	M77.01.F8.C1G	■	408
M73.00.G8.E8G	■	401	M75.01.F1.R4G	■	323	M77.01.F8.M5G	■	409
M73.00.H4.CRG	■	401	M75.01.F3.E8G	■	404	M77.01.G1.B1G	■	409
M73.00.H4.M5G	■	401	M75.01.F6.GPG	■	405	M77.01.G1.D1G	■	408
M73.00.H4.T4G	■	321	M75.01.F8.C1G	■	323	M77.01.G2.A8G	■	408
M73.01.F1.R4G	■	400	M75.01.F8.M5G	■	404	M77.01.G4.R4G	■	408
M73.01.F3.E8G	■	401	M75.01.F8.M5G	■	405	M77.01.G6.D1G	■	408
M73.01.F8.C1G	■	400	M75.01.G1.B1G	■	405	M77.01.G7.A8G	■	325
M73.01.F8.M5G	■	401	M75.01.G1.C1G	■	408	M77.01.G7.A8G	■	408
M73.01.F8.R3G	■	321	M75.01.G1.D1G	■	323	M77.01.G9.A8G	■	408
M73.01.G1.B1G	■	401	M75.01.G2.A8G	■	404	M77.01.G9.C2G	■	409
M73.01.G1.D1G	■	400	M75.01.G2.A8G	■	404	M77.01.G9.R3G	■	325
M73.01.G2.A8G	■	321	M75.01.G4.R4G	■	404	M77.01.H2.D1G	■	408
M73.01.G4.M2G	■	321	M75.01.G6.D1G	■	404	M77.01.H2.M5G	■	325
M73.01.G4.R4G	■	400	M75.01.G7.A8G	■	404	M77.01.H3.D1G	■	325
M73.01.G6.D1G	■	400	M75.01.G9.A8G	■	404	M77.01.H3.D1G	■	408
M73.01.G7.A8G	■	400	M75.01.G9.C2G	■	404	M77.01.H5.C2G	■	409
M73.01.G9.A8G	■	400	M75.01.G9.C2G	■	323	M77.01.H5.D1G	■	408
			M75.01.G9.R3G	■	405	M77.01.H5.E8G	■	409
			M75.01.H2.D1G	■	323	M77.01.H5.GPG	■	325
			M75.01.H3.D1G	■	404	M77.01.H7.D1G	■	408

CODE	LINEA	PAGE	CODE	LINEA	PAGE	CODE	LINEA	PAGE
M78		340	M81.00.G8.E8G		415	P03.00.04.06		429
M78.00.F7.R3G		411	M81.00.H4.CRG		415	P03.00.20.06		429
M78.00.G3.F7G		411	M81.00.H4.M5G		415	P03.00.25.06		429
M78.00.G8.E8G		411	M81.01.F1.R4G		414	P03.01.00.06		431
M78.00.H4.CRG		411	M81.01.F3.C1G		328	P03.01.01.06		430
M78.00.H4.M5G		411	M81.01.F3.E8G		415	P03.01.02.06		430
M78.00.H4.R3G		326	M81.01.F8.C1G		414	P03.01.05.06		430
M78.01.F1.R4G		410	M81.01.F8.M5G		415	P03.01.12.06		430
M78.01.F3.E8G		411	M81.01.G1.B1G		415	P03.01.22.06		430
M78.01.F8.C1G		410	M81.01.G1.D1G		414	P03.01.81.06		418
M78.01.F8.E8G		326	M81.01.G2.A8G		414	P03.02.00.01		426
M78.01.F8.M5G		411	M81.01.G4.R3G		328	P03.02.02.01		427
M78.01.G1.B1G		411	M81.01.G4.R4G		414	P03.02.04.01		427
M78.01.G1.D1G		410	M81.01.G6.D1G		414	P03.02.20.01		428
M78.01.G2.A8G		410	M81.01.G7.A8G		414	P03.10.00.01		426
M78.01.G4.C2G		326	M81.01.G7.T5G		328	P04		341
M78.01.G4.R4G		410	M81.01.G9.A8G		414	P04.00.00.06		431
M78.01.G6.D1G		410	M81.01.G9.C2G		415	P04.00.04.06		429
M78.01.G6.T5G		326	M81.01.G9.D1G		328	P04.00.20.06		429
M78.01.G7.A8G		326	M81.01.G9.R3G		415	P04.00.25.06		429
M78.01.G9.A8G		410	M81.01.H2.D1G		414	P04.00.77.02		429
M78.01.G9.C2G		411	M81.01.H2.R4G		328	P04.00M01B02		429
M78.01.G9.R3G		411	M81.01.H3.A8G		328	P04.00M01R02		429
M78.01.G9.R4G		326	M81.01.H3.D1G		414	P04.00M01V02		429
M78.01.H2.D1G		410	M81.01.H5.C2G		415	P04.01.00.06		431
M78.01.H3.D1G		410	M81.01.H5.D1G		410	P04.01.01.06		430
M78.01.H5.C2G		411	M81.01.H5.E8G		415	P04.01.02.06		430
M78.01.H5.D1G		326	M81.01.H7.D1G		414	P04.01.05.06		430
M78.01.H5.E8G		411	P01		341	P04.01.12.06		430
M78.01.H7.D1G		410	P01.00.00.06		431	P04.01.22.06		430
M80		340	P01.00.04.06		429	P04.01.81.06		418
M80.00.F7.R3G		413	P01.00.20.06		429	P04.02.00.01		426
M80.00.G3.F7G		413	P01.00.25.06		429	P04.02.02.01		427
M80.00.G8.E8G		413	P01.01.00.06		431	P04.02.04.01		427
M80.00.G8.R3G		327	P01.01.01.06		430	P04.02.20.01		428
M80.00.H4.CRG		413	P01.01.02.06		430	P04.10.00.01		426
M80.00.H4.E8G		327	P01.01.05.06		430	P05		341
M80.00.H4.M5G		413	P01.01.12.06		430	P05.00.00.06		431
M80.01.F1.R4G		412	P01.01.22.06		430	P05.00.04.06		429
M80.01.F3.D1G		327	P01.01.81.06		418	P05.00.20.06		429
M80.01.F3.E8G		413	P01.02.00.01		426	P05.00.25.06		429
M80.01.F8.C1G		412	P01.02.02.01		427	P05.01.00.06		431
M80.01.F8.M5G		413	P01.02.04.01		427	P05.01.01.06		430
M80.01.G1.B1G		413	P01.02.20.01		428	P05.01.02.06		430
M80.01.G1.C1G		327	P01.10.00.01		426	P05.01.05.06		430
M80.01.G2.A8G		412	P02		341	P05.01.12.06		430
M80.01.G4.R4G		412	P02.00.00.06		431	P05.01.22.06		430
M80.01.G6.D1G		412	P02.00.04.06		429	P05.01.81.06		418
M80.01.G7.A8G		412	P02.00.20.06		429	P05.02.00.01		426
M80.01.G9.A8G		412	P02.00.25.06		429	P05.02.02.01		427
M80.01.G9.C2G		413	P02.01.00.06		431	P05.02.04.01		427
M80.01.G9.R3G		413	P02.01.01.06		430	P05.02.20.01		428
M80.01.H2.D1G		412	P02.01.02.06		430	P05.10.00.01		426
M80.01.H2.T5G		327	P02.01.05.06		430	P06		342
M80.01.H3.A8G		327	P02.01.12.06		430	P06.00.00.06		431
M80.01.H3.D1G		412	P02.01.22.06		430	P06.01.00.06		431
M80.01.H5.C2G		327	P02.01.81.06		418	P06.01.01.06		430
M80.01.H5.D1G		412	P02.02.00.01		426	P06.01.05.06		430
M80.01.H5.E8G		413	P02.02.02.01		427	P06.01.22.06		430
M80.01.H7.D1G		412	P02.02.04.01		427	P06.02.00.01		426
M81		340	P02.02.20.01		428	P06.02.04.01		427
M81.00.F7.E8G		328	P02.10.00.01		426	P07		342
M81.00.F7.R3G		415	P03		341	P07.01.00.04		419
M81.00.G3.F7G		415	P03.00.00.06		431	P07.01.00.15		425

INDICE GENERALE

GENERAL INDEX

CODE	LINEA	PAGE	CODE	LINEA	PAGE	CODE	LINEA	PAGE
P07.01.00.15G	■	312	P11	■	343	P18.01.113.C1G	■	368
P07.01.00.D1G	■	312	P11.00.00.06	■	431	P18.01.113.C2G	■	368
P07.01.01.04	■	424	P11.01.00.06	■	431	P18.10.00.15G	■	369
P07.01.01.27	■	425	P11.02.00.01	■	426	P18.10.00.B1G	■	369
P07.01.02.04	■	424	P14	■	342	P18.10.00.D1G	■	369
P07.01.02.27	■	425	P14.01.00.04	■	420	P18.21.A5.D1G	■	368
P07.01.03.27	■	425	P14.01.81.04	■	420	P20	■	344
P07.01.04.04	■	424	P16	■	343	P23	■	344
P07.01.05.04	■	424	P16.01.00.15G	■	381	P23.00.00.04	■	420
P07.01.12.04	■	424	P16.01.00.C2G	■	381	P23.01.00.04	■	420
P07.01.20.04	■	422	P16.01.00.D1G	■	381	P23.02.00.01	■	420
P07.01.51.04	■	423	P16.01.01.15G	■	381	P23.10.00.01	■	420
P07.01.81.04	■	418	P16.01.01.D1G	■	381	P77	■	344
P07.01.81.D1G	■	312	P16.01.81.D1G	■	381	P77.00.F2.CRG	■	321
P07.01.90.15G	■	312	P16.01.A1.D1G	■	381	P77.00.F7.CRG	■	319 329
P07.01.A1.D1G	■	312	P16.01.B1.15G	■	381	P77.00.F7.E8G	■	328
P07.01.A4.D1G	■	312	P16.01.B1.D1G	■	381	P77.00.F7.M5G	■	318 320
P07.01.B4.D1G	■	312	P16.01.113.15G	■	381	P77.00.G3.E8G	■	325
P07.02.00.01	■	426	P16.01.113.D1G	■	381	P77.00.G3.M5G	■	323
P07.02.01.01	■	428	P16.10.00.D1G	■	381	P77.00.G3.T4G	■	319
P07.02.02.01	■	427	P17	■	343	P77.00.G8.R3G	■	322 327
P07.02.03.01	■	427	P17.01.00.15G	■	371	P77.00.H4.CRG	■	324
P07.02.05.01	■	428	P17.01.00.B1G	■	371	P77.00.H4.E8G	■	322 327 329
P07.02.12.01	■	428	P17.01.00.C1G	■	371	P77.00.H4.R3G	■	320 326
P07.02.20.01	■	428	P17.01.00.C2G	■	371	P77.00.H4.T4G	■	321
P07.10.00.01	■	426	P17.01.00.D1G	■	371	P77.01.F1.A8G	■	323
P08	■	342	P17.01.01.C1G	■	371	P77.01.F3.C1G	■	328
P08.01.00.04	■	419	P17.01.01.D1G	■	371	P77.01.F3.C2G	■	324 329
P08.01.00.15	■	425	P17.01.02.15G	■	371	P77.01.F3.D1G	■	327
P08.01.01.04	■	424	P17.01.02.D1G	■	371	P77.01.F3.GPG	■	320
P08.01.01.27	■	425	P17.01.12.15G	■	371	P77.01.F5.D1G	■	319
P08.01.02.04	■	424	P17.01.12.C1G	■	371	P77.01.F5.T5G	■	325
P08.01.02.27	■	425	P17.01.12.C2G	■	371	P77.01.F6.A8G	■	318
P08.01.03.27	■	425	P17.01.12.D1G	■	371	P77.01.F6.GPG	■	323
P08.01.04.04	■	424	P17.01.25.15G	■	371	P77.01.F8.A8G	■	322
P08.01.05.04	■	424	P17.01.81.C1G	■	371	P77.01.F8.C1G	■	329
P08.01.12.04	■	424	P17.01.81.C2G	■	371	P77.01.F8.E8G	■	326
P08.01.20.04	■	422	P17.01.81.D1G	■	371	P77.01.F8.R3G	■	321
P08.01.51.04	■	423	P17.01.A1.D1G	■	371	P77.01.F8.R4G	■	324
P08.01.81.04	■	418	P17.01.A4.15G	■	371	P77.01.G1.C1G	■	323 327
P08.02.00.01	■	426	P17.01.A4.C1G	■	371	P77.01.G2.A8G	■	321
P08.02.01.01	■	428	P17.01.A4.D1G	■	371	P77.01.G2.R4G	■	329
P08.02.02.01	■	427	P17.10.00.B1G	■	371	P77.01.G4.A8G	■	319
P08.02.03.01	■	427	P17.10.00.D1G	■	371	P77.01.G4.C2G	■	326
P08.02.05.01	■	428	P17.21.A5.D1G	■	371	P77.01.G4.M2G	■	321
P08.02.12.01	■	428	P18	■	343	P77.01.G4.R3G	■	328
P08.02.20.01	■	428	P18.01.00.15G	■	368	P77.01.G6.B1G	■	322
P08.10.00.01	■	426	P18.01.00.C2G	■	368	P77.01.G6.D1G	■	320
P09	■	342	P18.01.00.D1G	■	368	P77.01.G6.E8G	■	318
P09.01.00.04	■	419	P18.01.01.D1G	■	369	P77.01.G6.T5G	■	326
P09.01.00.15	■	425	P18.01.02.D1G	■	369	P77.01.G7.A8G	■	325 326
P09.01.01.04	■	424	P18.01.12.D1G	■	369	P77.01.G7.GPG	■	329
P09.01.01.27	■	425	P18.01.22.D1G	■	369	P77.01.G7.R4G	■	322
P09.01.03.27	■	425	P18.01.81.C1G	■	368	P77.01.G7.T5G	■	320 328
P09.01.04.04	■	424	P18.01.81.D1G	■	368	P77.01.G9.C1G	■	324
P09.01.05.04	■	424	P18.01.A1.D1G	■	368	P77.01.G9.C2G	■	318 323
P09.02.00.01	■	426	P18.01.A4.15G	■	368	P77.01.G9.D1G	■	328
P09.02.01.01	■	428	P18.01.A4.C2G	■	369	P77.01.G9.GPG	■	319
P09.02.03.01	■	427	P18.01.A4.D1G	■	368	P77.01.G9.R3G	■	325
P09.02.05.01	■	428	P18.01.A7.15G	■	369	P77.01.G9.R4G	■	326
P10	■	343	P18.01.A7.C1G	■	369	P77.01.H2.D1G	■	323 329
P10.00.00.06	■	431	P18.01.A7.C2G	■	369	P77.01.H2.E8G	■	324
P10.01.00.06	■	431	P18.01.A7.D1G	■	369	P77.01.H2.M5G	■	325
P10.02.00.01	■	426	P18.01.113.15G	■	368	P77.01.H2.R4G	■	328

CODE	LINEA	PAGE
P77.01.H2.T5G	■	318 327
P77.01.H3.A8G	■	320 324 327
P77.01.H3.D1G	■	322 325
P77.01.H3.R4G	■	318 319
P77.01.H5.C2G	■	320 322 327
P77.01.H5.D1G	■	318 321 326
P77.01.H5.E8G	■	319
P77.01.H5.GPG	■	325
P77.01.H5.R3G	■	329
P77.01.H5.T5G	■	323
P77.01.H7.C1G	■	321
P77.01.H7.D1G	■	324
P88	■	344
P88.00.F7.CRG	■	329
P88.00.H4.E8G	■	329
P88.01.F3.C2G	■	329
P88.01.F8.C1G	■	329
P88.01.G2.R4G	■	329
P88.01.G7.GPG	■	329
P88.01.H2.D1G	■	329
P88.01.H5.R3G	■	329
PN1	■	344
PN1.01.00.02	■	313
PN1.01.00.15	■	313
PN1.01.02.02	■	313
PN1.01.10.15	■	313
PN1.01.11.02	■	313
PN1.01.12.02	■	313
PN1.01.68.02	■	313
PN1.01.81.02	■	313
PN1.01.90.15	■	313
PN1.01.B1.02	■	313
P110	■	435



CODE 022 PAGE 023



CODE 314 PAGE 031



CODE 140 PAGE 038



CODE 020 PAGE 043



CODE 183 PAGE 047



CODE 005 PAGE 013



CODE 187 PAGE 024



CODE 691 PAGE 032



CODE 182 PAGE 039



CODE 025 PAGE 043

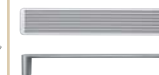

CODE 165 PAGE 048



CODE 119 PAGE 014



CODE 309 PAGE 025



CODE 336 PAGE 033



CODE 107 PAGE 039



CODE 130 PAGE 044



CODE 166 PAGE 048



CODE 019 PAGE 015



CODE 009 PAGE 026



CODE 002 PAGE 034



CODE 169 PAGE 039



CODE 142 PAGE 044



CODE 192 PAGE 049



CODE 300 PAGE 016



CODE 317 PAGE 027



CODE 006 PAGE 035



CODE 154 PAGE 040



CODE 132 PAGE 045



CODE 162 PAGE 049



CODE 329 PAGE 017



CODE 400 PAGE 028



CODE 108 PAGE 036



CODE 101 PAGE 040



CODE 128 PAGE 045



CODE 124 PAGE 050



CODE 040 PAGE 018



CODE 401 PAGE 028



CODE 126 PAGE 036



CODE 102 PAGE 040



CODE 144 PAGE 046



CODE 170 PAGE 050



CODE 334 PAGE 019



CODE 402 PAGE 028



CODE 134 PAGE 037



CODE 106 PAGE 041



CODE 185 PAGE 046



CODE 5090 PAGE 051



CODE 030 PAGE 020



CODE 403 PAGE 029



CODE 145 PAGE 037



CODE 153 PAGE 041



CODE 212 PAGE 046



CODE 5230 PAGE 051



CODE 031 PAGE 020



CODE 404 PAGE 029



CODE 180 PAGE 037



CODE 190 PAGE 042



CODE 112 PAGE 046



CODE 112 PAGE 051



CODE 011 PAGE 021



CODE 405 PAGE 029



CODE 138 PAGE 038



CODE 191 PAGE 042



CODE 105 PAGE 047



CODE 150 PAGE 052



CODE 001 PAGE 022



CODE 335 PAGE 030



CODE 136 PAGE 038



CODE 152 PAGE 042



CODE 163 PAGE 047



CODE 001 PAGE 053



CODE 651 PAGE 071



CODE 639 PAGE 109



CODE 653 PAGE 085



CODE 627 PAGE 096



CODE 638 PAGE 109



CODE 670 PAGE 121



CODE 682 PAGE 133



CODE 711 PAGE 145



CODE 188 PAGE 061



CODE 640 PAGE 072



CODE 670 PAGE 121



CODE 602 PAGE 086



CODE 624 PAGE 097



CODE 608 PAGE 110



CODE 669 PAGE 122



CODE 695 PAGE 134



CODE 712 PAGE 146



CODE 616 PAGE 062



CODE 605 PAGE 073



CODE 124 PAGE 159



CODE 660 PAGE 087



CODE 626 PAGE 098



CODE 606 PAGE 111



CODE 675 PAGE 123



CODE 671 PAGE 135

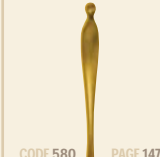

CODE 580 PAGE 147



CODE 612 PAGE 063



CODE 554 PAGE 074



CODE 611 PAGE 076



CODE 637 PAGE 088



CODE 625 PAGE 099



CODE 633 PAGE 112



CODE 684 PAGE 124



CODE 668 PAGE 136



CODE 689 PAGE 148



CODE 603 PAGE 064



CODE 552 PAGE 074



CODE 628 PAGE 077



CODE 614 PAGE 089



CODE 648 PAGE 100



CODE 550 PAGE 113



CODE 673 PAGE 125



CODE 704 PAGE 137



CODE 692 PAGE 149



CODE 604 PAGE 065



CODE 610 PAGE 064



CODE 652 PAGE 078



CODE 646 PAGE 090



CODE 649 PAGE 101



CODE 659 PAGE 114



CODE 688 PAGE 126



CODE 700 PAGE 138



CODE 718 PAGE 150



CODE 555 PAGE 066



CODE 540 PAGE 075



CODE 503 PAGE 079



CODE 635 PAGE 091



CODE 634 PAGE 102



CODE 666 PAGE 115



CODE 674 PAGE 127



CODE 701 PAGE 139



CODE 719 PAGE 151



CODE 108 PAGE 067



CODE 542 PAGE 075



CODE 622 PAGE 080



CODE 645 PAGE 092



CODE 636 PAGE 103



CODE 661 PAGE 116



CODE 696 PAGE 128



CODE 702 PAGE 140



CODE 142 PAGE 152



CODE 109 PAGE 067



CODE 541 PAGE 075



CODE 607 PAGE 081



CODE 645K PAGE 093



CODE 615 PAGE 104



CODE 662 PAGE 117



CODE 676 PAGE 129



CODE 703 PAGE 141



CODE 128 PAGE 152



CODE 601 PAGE 068



CODE 543 PAGE 075



CODE 619 PAGE 082



CODE 642 PAGE 094



CODE 647 PAGE 105



CODE 667 PAGE 118



CODE 683 PAGE 130



CODE 705 PAGE 142



CODE 132 PAGE 153



CODE 609 PAGE 069



CODE 900 PAGE 075



CODE 654 PAGE 083



CODE 536 PAGE 095



CODE 538 PAGE 106



CODE 655 PAGE 119



CODE 685 PAGE 131



CODE 706 PAGE 143



CODE 192 PAGE 153



CODE 650 PAGE 070



CODE 624 PAGE 097



CODE 5500 PAGE 084



CODE 537 PAGE 095



CODE 559 PAGE 107



CODE 600 PAGE 120





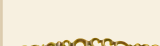









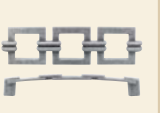























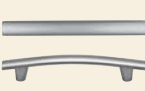

















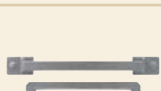









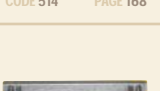







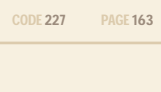













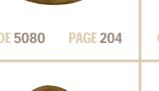

















CODE 697 PAGE 132















CODE 707 PAGE 144



CODE 139 PAGE 154

 CODE 212 PAGE 154	 CODE 533 PAGE 160	 CODE 222 PAGE 166	 CODE 040 PAGE 171	 CODE 5144 PAGE 180	 CODE 5220 PAGE 190	 CODE 5010 PAGE 198	 CODE 5199 PAGE 205	 CODE 5202 PAGE 208		
 CODE 134 PAGE 154	 CODE 221 PAGE 160	 CODE 224 PAGE 166	 CODE 39045 PAGE 172	 CODE 5133 PAGE 180	 CODE 5040 PAGE 192	 CODE 5017 PAGE 200	 CODE 5200 PAGE 205	 CODE 5197 PAGE 208		
 CODE 223 PAGE 155	 CODE 500 PAGE 161	 CODE 232 PAGE 167	 CODE 5091 PAGE 173	 CODE 5015 PAGE 182	 CODE 5218 PAGE 190	 CODE 5014 PAGE 200	 CODE 1022 PAGE 205	 CODE 5198 PAGE 208		
 CODE 102 PAGE 155	 CODE 501 PAGE 161	 CODE 225 PAGE 167	 CODE 112 PAGE 172	 CODE 5021 PAGE 182	 CODE 5214 PAGE 190	 CODE 5248 PAGE 201	 CODE 5190 PAGE 206	 CODE 5007 PAGE 209		
 CODE 120 PAGE 156	 CODE 226 PAGE 162	 CODE 515 PAGE 168	 CODE 5090 PAGE 173	 CODE 5016 PAGE 183	 CODE 5212 PAGE 190	 CODE 5033 PAGE 201	 CODE 5201 PAGE 206	 CODE 5000 PAGE 210		
 CODE 122 PAGE 156	 CODE 218 PAGE 162	 CODE 514 PAGE 168	 CODE 5092 PAGE 173	 CODE 5034 PAGE 183	 CODE 5216 PAGE 190	 CODE 5038 PAGE 202	 CODE 5205 PAGE 206	 CODE 5036 PAGE 210		
 CODE 220 PAGE 156	 CODE 227 PAGE 163	 CODE 516 PAGE 169	 CODE 5230 PAGE 173	 CODE 5132 PAGE 184	 CODE 5141 PAGE 192	 CODE 5020 PAGE 202	 CODE 5206 PAGE 206	 CODE 5052 PAGE 210		
 CODE 228 PAGE 157	 CODE 5072 PAGE 163	 CODE 516MN PAGE 169	 CODE 5094 PAGE 173	 CODE 5102 PAGE 184	 CODE 5101 PAGE 194	 CODE 5080 PAGE 204	 CODE 5195 PAGE 206	 CODE 5050 PAGE 211		
 CODE 216 PAGE 157	 CODE 229 PAGE 164	 CODE 534 PAGE 170	 CODE 5031 PAGE 173	 CODE 5039 PAGE 186	 CODE 5143 PAGE 194	 CODE 5081 PAGE 204	 CODE 5032 PAGE 206	 CODE 5035 PAGE 212		
 CODE 231 PAGE 158	 CODE 230 PAGE 164	 CODE 532 PAGE 170	<i>linea Classic</i>			 CODE 5140 PAGE 186	 CODE 5134 PAGE 196	 CODE 5022 PAGE 204	 CODE 1035 PAGE 206	 CODE 5003 PAGE 212
 CODE 214 PAGE 158	 CODE 133 PAGE 165	 CODE 5238 PAGE 171	 CODE 5118 PAGE 179	 CODE 5055 PAGE 188	 CODE 5026 PAGE 196	 CODE 5075 PAGE 204	 CODE 1036 PAGE 206	 CODE 5002 PAGE 213		
 CODE 215 PAGE 159	 CODE 504 PAGE 165	 CODE 5239 PAGE 171	 CODE 5029 PAGE 179	 CODE 5135 PAGE 188	 CODE 5011 PAGE 198	 CODE 5076 PAGE 204	 CODE 5203 PAGE 208	 CODE 5074 PAGE 213		

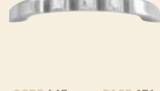
<p><i>linea Classic</i></p>	 CODE 5047 PAGE 218	 CODE 5079 PAGE 223	 CODE 1016 PAGE 251	 CODE 1005 PAGE 274	 CODE 9003 PAGE 277	 CODE 9023 PAGE 281	 CODE 9010 PAGE 288	 CODE M09 PAGE 364
 CODE 5049 PAGE 214	 CODE 5072 PAGE 219	 CODE 5042 PAGE 223	 CODE 1017 PAGE 251	 CODE 1048 PAGE 274	 CODE 9008 PAGE 278	 CODE 9015 PAGE 282	 CODE 9043 PAGE 289	 CODE M50 PAGE 382
 CODE 5001 PAGE 214	 CODE 5092 PAGE 219	 CODE 5012 PAGE 224	 CODE 1043 PAGE 252	 CODE 1049 PAGE 274	 CODE 9006 PAGE 278	 CODE 9028 PAGE 282	 CODE 9500 PAGE 291	 CODE M11 PAGE 374
 CODE 5048 PAGE 215	 CODE 5091 PAGE 219	 CODE 5009 PAGE 224	 CODE 1046 PAGE 252	 CODE 1006 PAGE 275	 CODE 9007 PAGE 278	 CODE 9013 PAGE 283	 CODE 0500 PAGE 292	 CODE M12 PAGE 388
 CODE 5044 PAGE 216	 CODE 5090 PAGE 219	 CODE 5019 PAGE 225	 CODE 1044 PAGE 253	 CODE 1057 PAGE 275	 CODE 9026 PAGE 279	 CODE 9014 PAGE 283	 CODE 0526 PAGE 293	 CODE M16 PAGE 380
 CODE 5043 PAGE 216	 CODE 5004 PAGE 220	 CODE 5054 PAGE 225	 CODE 1030 PAGE 253	 CODE 1014 PAGE 275	 CODE 9027 PAGE 279	 CODE 9044 PAGE 283	 CODE 0522 PAGE 297	 CODE M17 PAGE 366
 CODE 5051 PAGE 217	 CODE 5018 PAGE 220	<p><i>linea Classic Old Style</i></p>	 CODE 1031 PAGE 253	 CODE 1013 PAGE 275	 CODE 9025 PAGE 279	 CODE 9016 PAGE 284	<p><i>Linea Romantic</i></p>	 CODE M19 PAGE 372
 CODE 5041 PAGE 217	 CODE 5045 PAGE 221	 CODE 1021 PAGE 250	 CODE 1056 PAGE 254	 CODE 9000 PAGE 276	 CODE 9024 PAGE 280	 CODE 9017 PAGE 284	 CODE 188 PAGE 314	 CODE M21 PAGE 379
 CODE 5094 PAGE 218	 CODE 5005 PAGE 221	 CODE 1018 PAGE 250	 CODE 1058 PAGE 254	 CODE 9001 PAGE 276	 CODE 9018 PAGE 280	 CODE 9029 PAGE 285	 CODE 120 PAGE 316	 CODE M22 PAGE 384
 CODE 5031 PAGE 218	 CODE 5006 PAGE 221	 CODE 1023 PAGE 251	 CODE 1020 PAGE 254	 CODE 9004 PAGE 276	 CODE 9019 PAGE 280	 CODE 9030 PAGE 285	 CODE 122 PAGE 317	 CODE M24 PAGE 378
 CODE 5230 PAGE 218	 CODE 5077 PAGE 222	 CODE 1024 PAGE 251	 CODE 1063 PAGE 255	 CODE 9005 PAGE 277	 CODE 9020 PAGE 280	 CODE 9022 PAGE 286	 CODE M01 PAGE 362	 CODE M25 PAGE 336
 CODE 5600 PAGE 218	 CODE 5046 PAGE 222	 CODE 1015 PAGE 251	 CODE 1010 PAGE 274	 CODE 9002 PAGE 277	 CODE 9021 PAGE 280	 CODE 9012 PAGE 287	 CODE M07 PAGE 390	 CODE M26 PAGE 370

 CODE M27 PAGE 386	 CODE M71 PAGE 319	linea Luxury	 CODE 678 PAGE 453
 CODE M28 PAGE 377	 CODE M72 PAGE 320	 CODE 608 PAGE 439	 CODE 679 PAGE 453
 CODE M53 PAGE 376	 CODE M73 PAGE 321	 CODE 614 PAGE 440	 CODE 672 PAGE 454
 CODE M10 PAGE 360	 CODE M74 PAGE 322	 CODE 602 PAGE 441	 CODE 665 PAGE 455
 CODE M54 PAGE 356	 CODE M75 PAGE 323	 CODE 010 PAGE 442	 CODE 335KR PAGE 456
 CODE M51 PAGE 392	 CODE M76 PAGE 324	 CODE 005 PAGE 443	 CODE 691KR PAGE 457
 CODE M55 PAGE 309	 CODE M77 PAGE 325	 CODE 550 PAGE 444	 CODE 694 PAGE 458
 CODE M56 PAGE 310	 CODE M78 PAGE 326	 CODE 633 PAGE 446	 CODE 693 PAGE 459
 CODE M56.XX PAGE 311	 CODE M80 PAGE 327	 CODE 640 PAGE 448	 CODE 715 PAGE 460
 CODE M62 PAGE 312	 CODE M81 PAGE 328	 CODE 655 PAGE 450	 CODE 716KR PAGE 461
 CODE M63 PAGE 315	linea Ceramica	 CODE 667 PAGE 451	 CODE 716MB PAGE 462
 CODE M70 PAGE 318	 CODE P110 PAGE 435	 CODE 680 PAGE 452	 CODE 716MG PAGE 463

INDICE FOTOGRAFICO PHOTO INDEX

CONDIZIONI GENERALI DI VENDITA



ORDINI: ogni ordine è assunto con riserva di accettazione da parte della casa.

Gli ordini si intendono accettati esclusivamente con la trasmissione al committente della relativa conferma d'ordine. Le ordinazioni dovranno avvenire indicando i codici completi del catalogo; in caso contrario non ci assumiamo nessuna responsabilità per eventuali errori nell'evasione degli ordini derivati da indicazioni insufficienti. La qualità minima di ogni articolo deve essere intendersi di una confezione o multipla della stessa; quantità non multiple vengono automaticamente aumentate per eccesso. Il nostro sistema produttivo prevede delle eccedenze di produzione che vengono consegnate al cliente con una tolleranza del 10% circa. Quindi le quantità per confezione possono essere diverse dallo standard stabilito.

Ci riserviamo il diritto di annullare la proposta d'ordine prima della consegna della merce, senza obbligo di alcuna indennità.

PREZZI: Tutti i prezzi del ns. listino sono I.V.A. esclusa. I prezzi dei ns. articoli non comprendono le viti, le quali se desiderate dovranno essere specificate sulle commissioni d'ordine con relative misure e quantità.

Ci riserviamo il diritto di variare in qualsiasi momento e senza preavviso i prezzi del listino.

TERMINI DI CONSEGNA: il termine di consegna, anche se confermato, costituisce una semplice previsione ed ha un valore esclusivamente indicato. Eventuali ritardi nelle consegne non daranno diritto al compratore a nessuna pretesa di risarcimento danni o interessi.

TRASPORTO: gli ordini che si pervengono devono essere sempre indicare in quali dei due seguenti modi il cliente desidera che sia effettuato il trasporto:

o in porto assegnato

o in porto franco con addebito in fattura

La merce viaggia a rischio e pericolo del committente, qualunque sia il modo di spedizione; quindi ogni ns. responsabilità cessa al momento della consegna della merce al vettore.

FINITURE: le finiture illustrate sono puramente indicative.

MISURE: le misure sono indicative, la nostra ditta si riserva il diritto di apportare migliorie e modifiche in qualsiasi momento e senza preavviso.

CATALOGHI: tutto il materiale illustrativo resta di nostra proprietà. Non può essere ceduto a terzi e dovrà esserci restituito dietro nostra semplice richiesta.

MATERIALE DI FISSAGGIO: viene fornito solo su richiesta del cliente e non è incluso nel prezzo.

PAGAMENTI: i pagamenti potranno essere effettuati, a seconda degli accordi presi al momento dell'ordine: o ricevuta bancaria, o con rimessa diretta vista fattura. Detti pagamenti non possono essere ritardati per nessun motivo. Ogni eventuale diritto dell'acquirente dovrà essere fatto valere in separato in giudizio. In caso ritardo pagamento saranno applicati gli interessi di mora al tasso bancario del momento maggiorato del 5%, inoltre ci riserviamo il diritto di sospendere le forniture di merce. I pagamenti eseguiti a funzionari privi di ns. autorizzazione scritta non sono liberatori e non estinguono il debito contratto verso la ns. ditta.

RECLAMI E RESI: eventuali reclami dovranno prevenire presso la ns. sede tramite lettera raccomandata A/R o tramite fax, entro e non oltre 8 giorni dal ricevimento della merce. Non vengono presi in considerazione eventuali reclami fatti oltre il termine stabilito o fatti con modalità diverse da quanto sopra riportato. Non si accettano resi se non da noi espressamente autorizzati. La merce deve essere in ogni caso restituita dall'azienda in porto franco ed in perfetto stato. In caso contrario il reso verrà accreditato con una svalutazione adeguata al caso e calcolata a ns. indicabile giudizio. Non si accettano resi di articoli speciali, non inseriti nel ns. catalogo, espressamente ordinati dal committente.

COMPETENZA: in caso di contestazione il Tribunale competente è quello della ditta venditrice. Le predette condizioni si intendono accettare con l'ordinazione della merce.

GENERAL TERMS OF SALE



ORDERS: all orders that are received are subject to acceptance by the house. Orders are only accepted when the house has sent the customer the relative order confirmation. Orders must indicate complete catalogue codes. We shall not be responsible for order delivery errors that are caused by insufficient information. The minimum quantities for each article are understood to be for a package or for multiples of packages.

Quantities that are not multiples will be automatically increased to reach a multiple. Our production system foresees exceeding quantities, which are going to be delivered to the customer with a tolerance of about 10%. So the quantities contained in each packaging can be different from the established standard.

We reserve the right to cancel order proposal prior to delivery of the merchandise without assuming any obligation to pay indemnities. Orders shall be delivered within the limits set by available stock.

PRICES: all the prices in our price list are net of VAT. The prices for our articles do not include screws. If screws are desired then their dimension and quantities must be specified on the order form. We reserve the right to change prices list at any time and without giving advance notice.

DELIVERY TERMS: delivery terms, even if confirmed, are only an estimated forecast and have an exclusively indicative value. Delays in delivery shall not entitle the purchaser to claim any form of reimbursement for damages or interest.

SHIPMENT: orders sent to us must also specify in which of the following two ways the customer wants shipment to be performed:

carriage forward

carriage prepaid (billed in the invoice).

Goods travel at the risk of the purchaser no matter how they are shipped.

All our responsibilities cease the moment we deliver the goods to the carrier.

FINISHES: the finishes illustrated are only indicative.

DIMENSIONS: dimensions are indicative. Our firm reserves the right to bring changes and improvements at any time and without giving advance notice.

CATALOGUES: all illustrative materials remain our property, cannot be transferred to third parties and must be returned to us upon our request.

FIXING MATERIAL: these are furnished only if requested by the customer and are not included in the price.

PAYMENTS: payments can be made, depending on agreements at the time the order was placed: either by bank receipt or by direct remittance against invoice. These payments cannot be delayed for any reason.

All customer claims or right must be exercised in separate legal judgements.

Late payments shall be subject to penalty interest at bank rates increased by 5%. We also reserve the right to suspend deliveries of merchandise.

Payments made to executives without our written authorization are not redeeming and do not extinguish the debt contracted with our company.

CLAIMS AND RETURNS: any claims must be sent to our head office by registered letter or by fax within and no later than 8 days from date of receipt of the merchandise. Claims made after that term or by methods different from those listed above shall not be taken into consideration. Returns are not accepted unless we have explicitly authorized them. Merchandise must in any case be sent back to us free in port and in perfect condition. Otherwise the return shall be charged at a devaluation suited for the situation and performed according to our own unappealable judgement. Returns of special articles, not included in our catalogue and specifically ordered by the purchaser, shall not be accepted.

COURT OF JURISDICTION: the Seller's Court shall have jurisdiction over all disputes.

These conditions are understood to be accepted when orders for merchandise are placed.

Graphic: AZZOLINITINUPER-MILANO
Print: CENTRO STAMPA CEREAL-VR-

OTTOBRE / OCTOBER 2013



GIUSTI



La ditta Giusti S.p.A. si riserva il diritto di apportare modifiche senza preavviso. Pertanto dati tecnici, descrizioni, finiture ed illustrazioni contenute nel presente stampato non si intendono impegnativi.

Giusti S.p.A. reserves the right to make any modification, without notice. Therefore, all technical data, descriptions, finishes and illustrations contained in this catalogue are not to be considered binding.

CTA13M10G15

Industria maniglie
ed accessori per mobili
*Manufacturer handles
and furniture fittings*

Società del gruppo Ginvest
A company of Ginvest group